

# Diffeomorphisms of Elliptic 3-Manifolds

Sungbok Hong

John Kalliongis

Darryl McCullough

J. H. Rubinstein

Author address:

DEPARTMENT OF MATHEMATICS

KOREA UNIVERSITY

*E-mail address:* shong@korea.ac.kr

*URL:* math.korea.ac.kr/~shong/

DEPARTMENT OF MATHEMATICS

SAINT LOUIS UNIVERSITY

*E-mail address:* kalliongisje@slu.edu

*URL:* mathcs.slu.edu/people/kalliongisje

DEPARTMENT OF MATHEMATICS

UNIVERSITY OF OKLAHOMA

*E-mail address:* dmccullough@math.ou.edu

*URL:* math.ou.edu/~dmccullough/

DEPARTMENT OF MATHEMATICS

UNIVERSITY OF MELBOURNE

*E-mail address:* rubin@ms.unimelb.edu.au

*URL:* ms.unimelb.edu.au/~rubin/



## Contents

|  |    |
|--|----|
| Preface  | v  |
| Chapter 1. Elliptic 3-manifolds and the Smale Conjecture           | 1  |
| 1.1. Elliptic 3-manifolds and their isometries                     | 1  |
| 1.2. The Smale Conjecture  | 3  |
| 1.3. Isometries of nonelliptic 3-manifolds                         | 6  |
| 1.4. Perelman's methods  | 7  |
| Chapter 2. Diffeomorphisms and embeddings of manifolds             | 9  |
| 2.1. The $C^\infty$ -topology                                      | 9  |
| 2.2. Metrics which are products near the boundary                  | 10 |
| 2.3. Manifolds with boundary                                       | 11 |
| 2.4. Spaces of embeddings  | 14 |
| 2.5. Bundles and fiber-preserving diffeomorphisms                  | 14 |
| 2.6. Aligned vector fields and the aligned exponential             | 16 |
| Chapter 3. The method of Cerf and Palais                           | 19 |
| 3.1. The Palais-Cerf Restriction Theorem                           | 22 |
| 3.2. The space of images   | 26 |
| 3.3. Projection of fiber-preserving diffeomorphisms                | 28 |
| 3.4. Restriction of fiber-preserving diffeomorphisms               | 31 |
| 3.5. Restriction theorems for orbifolds                            | 33 |
| 3.6. Singular fiberings  | 39 |
| 3.7. Spaces of fibered structures                                  | 45 |
| 3.8. Restricting to the boundary or the basepoint                  | 49 |
| 3.9. The space of Seifert fiberings of a Haken 3-manifold          | 52 |
| 3.10. The Parameterized Extension Principle                        | 57 |
| Chapter 4. Elliptic 3-manifolds containing one-sided Klein bottles | 59 |
| 4.1. The manifolds $M(m, n)$                                       | 59 |
| 4.2. Outline of the proof  | 61 |
| 4.3. Isometries of elliptic 3-manifolds                            | 64 |
| 4.4. The Hopf fibering of $M(m, n)$ and special Klein bottles      | 66 |
| 4.5. Homotopy type of the space of diffeomorphisms                 | 75 |
| 4.6. Generic position configurations                               | 76 |

|  |     |
|--|-----|
| 4.7. Generic position families                   | 84  |
| 4.8. Parameterization                            | 86  |
| Chapter 5. Lens spaces                           | 95  |
| 5.1. Outline of the proof                        | 95  |
| 5.2. Reductions                                  | 97  |
| 5.3. Annuli in solid tori                        | 99  |
| 5.4. Heegaard tori in very good position         | 101 |
| 5.5. Sweepouts, and levels in very good position | 105 |
| 5.6. The Rubinstein-Scharlemann graphic          | 108 |
| 5.7. Graphics having no unlabeled region         | 113 |
| 5.8. Graphics for parameterized families         | 116 |
| 5.9. Finding good regions                        | 134 |
| 5.10. From good to very good                     | 142 |
| 5.11. Setting up the last step                   | 148 |
| 5.12. Deforming to fiber-preserving families     | 150 |
| 5.13. Parameters in $D^d$                        | 162 |
| Bibliography                                     | 165 |
| Index  | 169 |

## Preface

This work is ultimately directed at understanding the diffeomorphism groups of elliptic 3-manifolds— those closed 3-manifolds that admit a Riemannian metric of constant positive curvature. The main results concern the Smale Conjecture. The original Smale Conjecture, proven by A. Hatcher [24], asserts that if  $M$  is the 3-sphere with the standard constant curvature metric, the inclusion  $\text{Isom}(M) \rightarrow \text{Diff}(M)$  from the isometry group to the diffeomorphism group is a homotopy equivalence. The *Generalized Smale Conjecture* (henceforth just called the Smale Conjecture) asserts this whenever  $M$  is an elliptic 3-manifold.

Here are our main results:

1. The Smale Conjecture holds for elliptic 3-manifolds containing geometrically incompressible Klein bottles (Theorem 1.2.2). These include all quaternionic and prism manifolds.
2. The Smale Conjecture holds for all lens spaces  $L(m, q)$  with  $m \geq 3$  (Theorem 1.2.3).

Many of the cases in Theorem 1.2.2 were proven a number of years ago by N. Ivanov [32, 34, 35, 36] (see Section 1.2).

Some of our other results concern the groups of diffeomorphisms  $\text{Diff}(\Sigma)$  and fiber-preserving diffeomorphisms  $\text{Diff}_f(\Sigma)$  of a Seifert-fibered Haken 3-manifold  $\Sigma$ , and the coset space  $\text{Diff}(\Sigma)/\text{Diff}_f(\Sigma)$ , which is called the space of Seifert fiberings (equivalent to the given fibering) of  $\Sigma$ .

3. Apart from a small list of known exceptions,  $\text{Diff}_f(\Sigma) \rightarrow \text{Diff}(\Sigma)$  is a homotopy equivalence (Theorem 3.9.3).
4. The space of Seifert fiberings of  $\Sigma$  has contractible components (Theorem 3.9.2), and apart from a small list of known exceptions, it is contractible (Theorem 3.9.3).

These may be already accepted as part of the overall 3-dimensional landscape, but we are unable to find any serious treatment of them. And we have found that the development of the necessary tools and their application to the 3-dimensional context goes well beyond a routine exercise.

This manuscript includes work done more than twenty years ago, as well as work recently completed. In the mid-1980's, two of the authors (DM and JHR) sketched an argument proving the Smale Conjecture for the 3-manifolds that contain one-sided Klein bottles (other than the lens space  $L(4, 1)$ ). That method, which ultimately became Chapter 4 below, underwent a long evolution as various additions were made to fill in technical details.

The case of one-sided Klein bottles includes some lens spaces—those of the form  $L(4n, 2n - 1)$  for  $n \geq 2$ . But for the general lens space case, a different approach using Heegaard tori was developed by SH and DM starting around 2000. It is based on a powerful methodology developed by JHR and M. Scharlemann [58]. It turned out that JHR was working on the Smale Conjecture for lens spaces along exactly the same lines as SH and DM, so the efforts were combined in the work that became Chapter 5 below.

One more case of the Smale Conjecture may be accessible to existing techniques. It seems likely that A. Hatcher's approach to the  $S^3$  case in [24] would also serve for  $\mathbb{R}P^3$ , but this has yet to be carried out.

In summary, this is where the Smale Conjecture now stands:

| case                             | SC proven                                   |
|----------------------------------|---|
| $S^3$                            | Hatcher [24]                                |
| $\mathbb{R}P^3$                  |   |
| lens spaces                      | Chapter 5 below                             |
| prism and quaternionic manifolds | Ivanov [34, 32, 35, 36],<br>Chapter 4 below |
| tetrahedral manifolds            |   |
| octahedral manifolds             |   |
| icosahedral manifold             |   |

Our work on the Smale Conjecture requires some basic theory about spaces of mappings of smooth manifolds, such as the fact that diffeomorphism groups of compact manifolds and spaces of embeddings of submanifolds have the homotopy type of CW-complexes, a result originally proven by R. Palais. This theory is well known to global analysts and others, but not to many low-dimensional topologists. Also, most sources do not discuss the case of manifolds with boundary, and we know of no existing treatment of the case of fiber-preserving diffeomorphisms and embeddings, which is the context of much of our technical work. For this reason, we have included a fair dose of foundational

material on diffeomorphism groups in Chapter 2, which includes the case of manifolds with boundary, with the additional boundary control that we will need.

A more serious gap in the literature is the absence of versions of the fundamental restriction fibration theorems of Palais and Cerf in the context of fibered (and Seifert-fibered) manifolds. These extensions of the well-known theory require some new ideas, which were developed by JK and DM and form most of Chapter 3. We work in a class of singular fiberings large enough to include all Seifert fiberings of 3-manifolds, except some fiberings of lens spaces. These results are heavily used in our work in Chapters 4 and 5. Our results on fiber-preserving diffeomorphisms and the space of fibered structures of a Seifert-fibered Haken 3-manifold are applications of this work, and also appear in Chapter 3.

As a final note, we mention that much of our work here is unusually detailed and technical. In considerable part, this is inherent complication, but it also reflects the fact that over the years we have filled in many arguments in response to recommendations from various readers. Unfortunately, one reader's "too sketchy" can be another's "too much elaboration of well-known facts", and personally we find some of the current exposition to be somewhat too long and too detailed. To provide an alternative, we have included Sections 4.2 and 5.1, which are overviews of the proofs of the main results. In the actual proofs, we trust that each reader will simply accept the "obvious" parts and focus on the "nontrivial" parts, whichever they may be.

The authors are grateful to many sources of support during the lengthy preparation of this work. They include the Australian Research Council, the Korea Research Foundation, the Basic Science Research Center of Korea University, Saint Louis University, the U. S. National Science Foundation, the Mathematical Sciences Research Institute, the University of Oklahoma Vice President for Research, and the University of Oklahoma College of Arts and Sciences. We also thank the referees of versions of this work for occasional corrections and many helpful suggestions.





## CHAPTER 1

### Elliptic 3-manifolds and the Smale Conjecture

As noted in the Preface, the Smale Conjecture is the assertion that the inclusion  $\text{Isom}(M) \rightarrow \text{Diff}(M)$  is a homotopy equivalence whenever  $M$  is an elliptic 3-manifold, that is, a 3-manifold admitting a Riemannian metric of constant positive curvature. The Geometrization Conjecture, now proven by Perelman, shows that all closed 3-manifolds with finite fundamental group are elliptic.

In this chapter, we will first review elliptic 3-manifolds and their isometry groups. In the second section, we will state our main results on the Smale Conjecture, and provide some historical context. In the final two sections, we discuss isometries of nonelliptic 3-manifolds, and address the possibility of applying Perelman's methods to the Smale Conjecture.

#### 1.1. Elliptic 3-manifolds and their isometries

The elliptic 3-manifolds were completely classified long ago. They are exactly the 3-manifolds whose universal cover can be uniformized as the unit sphere  $S^3$  in  $\mathbb{R}^4$  so that  $\pi_1(M)$  acts freely as a subgroup of  $\text{Isom}_+(S^3) = \text{SO}(4)$ . The subgroups of  $\text{SO}(4)$  that act freely were first determined by Hopf and Seifert-Threlfall, and reformulated using quaternions by Hattori. References include [74] (pp. 226-227), [49] (pp. 103-113), [60] (pp. 449-457), [59], and [46].

The isometry groups of elliptic 3-manifolds have also been known for a long time, and are topologically rather simple: they are compact Lie groups of dimension at most 6. A detailed calculation of the isometry groups of elliptic 3-manifolds was given in [46], and in this section we will recall the resulting groups.

To set notation, recall that there is a well-known 2-fold covering  $S^3 \rightarrow \text{SO}(3)$ , which is a homomorphism when  $S^3$  is regarded as the group of unit quaternions (see Section 4.3 for a fuller discussion). The elements of  $\text{SO}(3)$  that preserve a given axis, say the  $z$ -axis, form the orthogonal subgroup  $\text{O}(2)$ . We will denote by  $\text{O}(2)^*$  the inverse image in  $S^3$  of  $\text{O}(2)$ . When  $H_1$  and  $H_2$  are groups, each containing  $-1$  as a central involution, the quotient  $(H_1 \times H_2)/\langle(-1, -1)\rangle$  is denoted

by  $H_1 \widetilde{\times} H_2$ . In particular,  $\mathrm{SO}(4)$  itself is  $S^3 \widetilde{\times} S^3$ , and contains the subgroups  $S^1 \widetilde{\times} S^3$ ,  $\mathrm{O}(2)^* \widetilde{\times} \mathrm{O}(2)^*$ , and  $S^1 \widetilde{\times} S^1$ . The latter is isomorphic to  $S^1 \times S^1$ , but it is sometimes useful to distinguish between them. Finally,  $\mathrm{Dih}(S^1 \times S^1)$  is the semidirect product  $(S^1 \times S^1) \circ C_2$ , where  $C_2$  acts by complex conjugation in both factors.

There are 2-fold covering homomorphisms

$$\mathrm{O}(2)^* \times \mathrm{O}(2)^* \rightarrow \mathrm{O}(2)^* \widetilde{\times} \mathrm{O}(2)^* \rightarrow \mathrm{O}(2) \times \mathrm{O}(2) \rightarrow \mathrm{O}(2) \widetilde{\times} \mathrm{O}(2) .$$

Each of these groups is diffeomorphic to four disjoint copies of the torus, but they are pairwise nonisomorphic. Indeed, they are easily distinguished by examining their subsets of order 2 elements. Similarly,  $S^1 \times S^3$  and  $S^1 \widetilde{\times} S^3$  are diffeomorphic, but nonisomorphic.

Table 1 gives the isometry groups of the elliptic 3-manifolds with non-cyclic fundamental group. The first column,  $G$ , indicates the fundamental group of  $M$ , where  $C_m$  denotes a cyclic group of order  $m$ , and  $D_{4m}^*$ ,  $T_{24}^*$ ,  $O_{48}^*$ , and  $I_{120}^*$  are the binary dihedral, tetrahedral, octahedral, and icosahedral groups of the indicated orders. The groups called index 2 and index 3 diagonal are certain subgroups of  $D_{4m}^* \times C_{4m}$  and  $T_{24}^* \times C_{6n}$  respectively. The last two columns give the full isometry group  $\mathrm{Isom}(M)$ , and the group  $\mathcal{I}(M)$  of path components of  $\mathrm{Isom}(M)$ .

Section 4.3 contains the detailed calculation of  $\mathrm{isom}(M)$ , the connected component of  $\mathrm{id}_M$  in  $\mathrm{Isom}(M)$ , for the elliptic 3-manifolds that contain one-sided incompressible Klein bottles— the quaternionic and prism manifolds, and the lens spaces of the form  $L(4n, 2n - 1)$ — since the notation and some of the mechanics of this are needed for the arguments in Chapter 4.

Table 2 gives the isometry groups of the elliptic 3-manifolds with cyclic fundamental group. These are the 3-sphere  $L(1, 0)$ , real projective space  $L(2, 1)$ , and the lens spaces  $L(m, q)$  with  $m \geq 3$ .

| $G$                    | $M$          | $\text{Isom}(M)$          | $\mathcal{I}(M)$ |
|------------------------|--------------|---------------------------|------------------|
| $Q_8$                  | quaternionic | $\text{SO}(3) \times S_3$ | $S_3$            |
| $Q_8 \times C_n$       | quaternionic | $\text{O}(2) \times S_3$  | $C_2 \times S_3$ |
| $D_{4m}^*$             | prism        | $\text{SO}(3) \times C_2$ | $C_2$            |
| $D_{4m}^* \times C_n$  | prism        | $\text{O}(2) \times C_2$  | $C_2 \times C_2$ |
| index 2 diagonal       | prism        | $\text{O}(2) \times C_2$  | $C_2 \times C_2$ |
| $T_{24}^*$             | tetrahedral  | $\text{SO}(3) \times C_2$ | $C_2$            |
| $T_{24}^* \times C_n$  | tetrahedral  | $\text{O}(2) \times C_2$  | $C_2 \times C_2$ |
| index 3 diagonal       | tetrahedral  | $\text{O}(2)$             | $C_2$            |
| $O_{48}^*$             | octahedral   | $\text{SO}(3)$            | $\{1\}$          |
| $O_{48}^* \times C_n$  | octahedral   | $\text{O}(2)$             | $C_2$            |
| $I_{120}^*$            | icosahedral  | $\text{SO}(3)$            | $\{1\}$          |
| $I_{120}^* \times C_n$ | icosahedral  | $\text{O}(2)$             | $C_2$            |

TABLE 1. Isometry groups of  $M = S^3/G$  ( $m > 2, n > 1$ )

| $m, q$   | $\text{Isom}(L(m, q))$                         | $\mathcal{I}(L(m, q))$ |
|--|--|------------------------|
| $m = 1$ ( $L(1, 0) = S^3$ )  | $\text{O}(4)$                                  | $C_2$                  |
| $m = 2$ ( $L(2, 1) = \mathbb{RP}^3$ )  | $(\text{SO}(3) \times \text{SO}(3)) \circ C_2$ | $C_2$                  |
| $m > 2, m$ odd, $q = 1$  | $\text{O}(2)^* \tilde{\times} S^3$             | $C_2$                  |
| $m > 2, m$ even, $q = 1$   | $\text{O}(2) \times \text{SO}(3)$              | $C_2$                  |
| $m > 2, 1 < q < m/2, q^2 \not\equiv \pm 1 \pmod{m}$                              | $\text{Dih}(S^1 \times S^1)$                   | $C_2$                  |
| $m > 2, 1 < q < m/2, q^2 \equiv -1 \pmod{m}$                                     | $(S^1 \tilde{\times} S^1) \circ C_4$           | $C_4$                  |
| $m > 2, 1 < q < m/2, q^2 \equiv 1 \pmod{m},$<br>$\gcd(m, q+1) \gcd(m, q-1) = m$  | $\text{O}(2) \tilde{\times} \text{O}(2)$       | $C_2 \times C_2$       |
| $m > 2, 1 < q < m/2, q^2 \equiv 1 \pmod{m},$<br>$\gcd(m, q+1) \gcd(m, q-1) = 2m$ | $\text{O}(2) \times \text{O}(2)$               | $C_2 \times C_2$       |

TABLE 2. Isometry groups of  $L(m, q)$ 

## 1.2. The Smale Conjecture

S. Smale [64] proved that for the standard round 2-sphere  $S^2$ , the inclusion of the isometry group  $\text{O}(3)$  into the diffeomorphism group  $\text{Diff}(S^2)$  is a homotopy equivalence. He conjectured that the analogous

result holds true for the 3-sphere, that is, that  $O(4) \rightarrow \text{Diff}(S^3)$  is a homotopy equivalence. J. Cerf [11] proved that the inclusion induces a bijection on path components, and the full conjecture was proven by A. Hatcher [24].

A weak form of the (generalized) Smale Conjecture is known. In [46], the calculations of  $\text{Isom}(M)$  for elliptic 3-manifolds are combined with results on mapping class groups of many authors, including [2, 5, 6, 56, 57], to obtain the following statement:

**THEOREM 1.2.1.** *Let  $M$  be an elliptic 3-manifold. Then the inclusion of  $\text{Isom}(M)$  into  $\text{Diff}(M)$  is a bijection on path components.*

This can be called the “ $\pi_0$ -part” of the Smale Conjecture. By virtue of this result, to prove the Smale Conjecture for any elliptic 3-manifold, it is sufficient to prove that the inclusion  $\text{isom}(M) \rightarrow \text{diff}(M)$  of the connected components of the identity map in  $\text{Isom}(M)$  and  $\text{Diff}(M)$  is a homotopy equivalence.

The earliest work on the Smale Conjecture was by N. Ivanov. Certain elliptic 3-manifolds contain one-sided geometrically incompressible Klein bottles. Fixing such a Klein bottle  $K_0$ , called the base Klein bottle, the remainder of the 3-manifold is an open solid torus, and (up to isotopy) there are two Seifert fiberings, one for which the Klein bottle is fibered by nonsingular fibers (the “meridional” fibering), and one for which it contains two exceptional fibers of type  $(2, 1)$  (the “longitudinal” fibering). As will be detailed in Section 4.1 below, the manifolds then fall into four types:

- I. Those for which neither the meridional nor the longitudinal fibering is nonsingular on the complement of  $K_0$ .
- II. Those for which only the longitudinal fibering is nonsingular on the complement of  $K_0$ . These are the lens spaces  $L(4n, 2n - 1)$ ,  $n \geq 2$ .
- III. Those for which only the meridional fibering is nonsingular on the complement of  $K_0$ .
- IV. The lens space  $L(4, 1)$ , for which both the meridional and longitudinal fiberings are nonsingular on the complement of  $K_0$ .

Cases I and III are the quaternionic and prism manifolds.

Ivanov announced the Smale Conjecture for Cases I and II in [32, 34], and gave a detailed proof for Case I in [35, 36]. One of our main theorems extends those results to all cases:

**THEOREM 1.2.2** (Smale Conjecture for elliptic 3-manifolds containing incompressible Klein bottles). *Let  $M$  be an elliptic 3-manifold containing a geometrically incompressible Klein bottle. Then  $\text{Isom}(M) \rightarrow \text{Diff}(M)$  is a homotopy equivalence.*

Theorem 1.2.2 is proven in Chapter 4, except for the case of  $L(4, 1)$ , which is proven in Chapter 5.

Our second main result concerns lens spaces, which for us refers only to the lens spaces  $L(m, q)$  with  $m \geq 3$ :

**THEOREM 1.2.3** (Smale Conjecture for lens spaces). *For any lens space  $L$ , the inclusion  $\text{Isom}(L) \rightarrow \text{Diff}(L)$  is a homotopy equivalence.*

One consequence of the Smale Conjecture is the determination of the homeomorphism type of  $\text{Diff}(M)$ . Recall that a Fréchet space is a locally convex complete metrizable linear space. In Section 2.1, we will review the fact that if  $M$  is a closed smooth manifold, then with the  $C^\infty$ -topology,  $\text{Diff}(M)$  is a second countable infinite-dimensional manifold locally modeled on the Fréchet space of smooth vector fields on  $M$ . By the Anderson-Kadec Theorem [4, Corollary VI.5.2], every infinite-dimensional Fréchet space is homeomorphic to  $\mathbb{R}^\infty$ , the countable product of lines. A theorem of Henderson and Schori ([4, Theorem IX.7.3], originally announced in [28]) shows that if  $Y$  is any locally convex space with  $Y$  homeomorphic to  $Y^\infty$ , then manifolds locally modeled on  $Y$  are homeomorphic whenever they have the same homotopy type. Therefore our main theorems give immediately the homeomorphism type of  $\text{Diff}(M)$ :

**COROLLARY.** *Let  $M$  be an elliptic 3-manifold which either contains an incompressible Klein bottle or is a lens space  $L(m, q)$  with  $m \geq 3$ . Then  $\text{Diff}(M)$  is homeomorphic to  $\text{Isom}(M) \times \mathbb{R}^\infty$ .*

Combining this with the calculations of  $\text{Isom}(M)$  in Table 1 gives the following homeomorphism classification of  $\text{Diff}(M)$ , in which  $P_n$  denotes the discrete space with  $n$  points:

**COROLLARY.** *Let  $M$  be an elliptic 3-manifold, not a lens space, containing an incompressible Klein bottle.*

- (1) *If  $M$  is the quaternionic manifold with fundamental group  $Q_8 = D_8^*$ , then  $\text{Diff}(M) \approx P_6 \times \text{SO}(3) \times \mathbb{R}^\infty$ .*
- (2) *If  $M$  is a quaternionic manifold with fundamental group  $Q_8 \times C_n$ ,  $n > 2$ , then  $\text{Diff}(M) \approx P_{12} \times S^1 \times \mathbb{R}^\infty$ .*
- (3) *If  $M$  is a prism manifold with fundamental group  $D_{4m}^*$ ,  $m \geq 3$ , then  $\text{Diff}(M) \approx P_2 \times \text{SO}(3) \times \mathbb{R}^\infty$ .*
- (4) *If  $M$  is any other prism manifold, then  $\text{Diff}(M) \approx P_4 \times S^1 \times \mathbb{R}^\infty$ .*

Similarly, using Table 2, we obtain a complete classification of  $\text{Diff}(L)$  for lens spaces into four homeomorphism types:

COROLLARY. *For a lens space  $L(m, q)$  with  $m \geq 3$ , the homeomorphism type of  $\text{Diff}(L)$  is as follows:*

- (1) *For  $m$  odd,  $\text{Diff}(L(m, 1)) \approx P_2 \times S^1 \times S^3 \times \mathbb{R}^\infty$ .*
- (2) *For  $m$  even,  $\text{Diff}(L(m, 1)) \approx P_2 \times S^1 \times \text{SO}(3) \times \mathbb{R}^\infty$ .*
- (3) *For  $q > 1$  and  $q^2 \not\equiv \pm 1 \pmod{m}$ ,  $\text{Diff}(L(m, q)) \approx P_2 \times S^1 \times S^1 \times \mathbb{R}^\infty$ .*
- (4) *For  $q > 1$  and  $q^2 \equiv \pm 1 \pmod{m}$ ,  $\text{Diff}(L(m, q)) \approx P_4 \times S^1 \times S^1 \times \mathbb{R}^\infty$ .*

We remark that the homeomorphism classification is quite different from the isomorphism classification. In fact, for *any* smooth manifold, the *isomorphism type* of  $\text{Diff}(M)$  determines  $M$ . That is, an abstract isomorphism between the diffeomorphism groups of two differentiable manifolds must be induced by a diffeomorphism between the manifolds [3, 13, 66].

The Smale Conjecture has some other applications, beyond the problem of understanding  $\text{Diff}(M)$ . Ivanov's results were used in [43] to construct examples of homeomorphisms of reducible 3-manifolds that are homotopic but not isotopic. Our results show that the construction applies to a larger class of 3-manifolds. In [55], Theorem 1.2.2 was applied to the classification problem for 3-manifolds which have metrics of positive Ricci curvature and universal cover  $S^3$ .

The Smale Conjecture has attracted the interest of physicists studying the theory of quantum gravity. Certain physical configuration spaces can be realized as the quotient space of a principal  $\text{Diff}_1(M, x_0)$ -bundle with contractible total space, where  $\text{Diff}_1(M, x_0)$  denotes the subgroup of  $\text{Diff}(M, x_0)$  that induce the identity on the tangent space to  $M$  at  $x_0$ . (This group is homotopy equivalent to  $\text{Diff}(M \# D^3 \text{ rel } \partial D^3)$ .) Consequently the loop space of the configuration space is weakly homotopy equivalent to  $\text{Diff}_1(M, x_0)$ . Physical significance of  $\pi_0(\text{Diff}(M))$  for quantum gravity was first pointed out in [14]. See also [1, 18, 30, 65, 73]. The physical significance of some higher homotopy groups of  $\text{Diff}(M)$  was examined by D. Giulini [17].

### 1.3. Isometries of nonelliptic 3-manifolds

For Haken 3-manifolds, Hatcher ([22], combined with [24]), extending earlier work of Laudenbach [42], proved that the components of  $\text{Diff}(M \text{ rel } \partial M)$  have the expected homotopy types (contractible, except when  $\partial M$  is empty, in which case they are homotopy equivalent to  $(S^1)^k$ , where  $k$  is the rank of the center of  $\pi_1(M)$ ). The same was accomplished by Ivanov [31]. The main part of the argument is to show that the space of embeddings of a two-sided incompressible surface  $F$

that are disjoint from a parallel copy of  $F$  is a deformation retract of the space of all embeddings of  $F$  (isotopic to the inclusion relative to  $\partial F$ ). Using his “insulator” methodology, D. Gabai [15] proved that the components of  $\text{Diff}(M)$  are contractible for all hyperbolic 3-manifolds.

The analogue of the Smale Conjecture holds for (compact) 3-manifolds whose interiors have constant negative curvature and finite volume: in fact, D. Gabai [15] showed that both  $\text{Isom}(M) \rightarrow \text{Diff}(M)$  and  $\text{Diff}(M) \rightarrow \text{Out}(\pi_1(M))$  are homotopy equivalences for finite-volume hyperbolic 3-manifolds (for hyperbolic 3-manifolds that are also Haken, this was already known by Mostow Rigidity, Waldhausen’s Theorem, and the work of Hatcher and Ivanov already discussed). The same statement has also been proven [47] when  $M$  has an  $\mathbb{H}^2 \times \mathbb{R}$  or  $\widetilde{\text{SL}}_2(\mathbb{R})$  geometry and its (unique, up to isotopy) Seifert-fibered structure has base orbifold the 2-sphere with three cone points. This is expected to hold for the Nil geometry as well.

In contrast, when the manifold has interior of constant negative curvature and infinite volume, or has constant zero curvature, a diffeomorphism will not in general be isotopic to an isometry (said differently, the diffeomorphism group may have more components than the isometry group). Even in these cases, however, Waldhausen’s Theorem and Hatcher’s work show that for a maximally symmetric Riemannian metric on  $M$ ,  $\text{Isom}(M) \rightarrow \text{Diff}(M)$  is a homotopy equivalence when one restricts to the connected components of  $\text{id}_M$ .

#### 1.4. Perelman’s methods

It is natural to ask whether the Smale Conjecture can be proven using the methodology that G. Perelman developed to prove the Geometrization Conjecture. The Smale Conjecture would follow if there were a flow retracting the space  $\mathcal{R}$  of all Riemannian metrics on an elliptic 3-manifold  $M$  to the subspace  $\mathcal{R}_c$  of metrics of constant positive curvature. Here is why this is so. First, note that by rescaling,  $\mathcal{R}_c$  deformation retracts to the subspace  $\mathcal{R}_1$  of metrics of constant curvature 1. Now,  $\text{Diff}(M)$  acts by pullback on  $\mathcal{R}_1$ ; this action is transitive (given two constant curvature metrics on  $M$ , the developing map gives a diffeomorphism which is an isometry between the lifted metrics on the universal cover, and since the action of  $\pi_1(M)$  is known to be unique up to conjugation by an isometry, this diffeomorphism can be composed with some isometry to make it equivariant) and the stabilizer of each point is a subgroup conjugate to  $\text{Isom}(M)$ , so  $\mathcal{R}_1$  may be identified with the coset space  $\text{Isom}(M) \backslash \text{Diff}(M)$ . On the other hand,  $\mathcal{R}$  is contractible ( $M$  is parallelizable and one can use a Gram-Schmidt

orthonormalization process). So the existence of a flow retracting  $\mathcal{R}$  to  $\mathcal{R}_c$  would imply that  $\text{Isom}(M) \setminus \text{Diff}(M)$  is contractible, which is equivalent to the Smale Conjecture. Finding a flow that retracts  $\mathcal{R}$  to  $\mathcal{R}_c$  is, of course, the rough idea of the Hamilton-Perelman program. At the present time, however, we do not see any way to carry this out, due to the formation of singularities and the requisite surgery of necks, and we are unaware of any progress in this direction.



## CHAPTER 2

### Diffeomorphisms and embeddings of manifolds

This chapter contains foundational material on spaces of diffeomorphisms and embeddings. Such spaces are known to be Fréchet manifolds, separable when the manifolds involved are compact. We will need versions of these and related facts for manifolds with boundary, and also in the context of fiber-preserving diffeomorphisms and maps. For the latter, a new (to us, at least) idea is required—the aligned exponential introduced in Section 2.6. It will also be heavily used in Chapter 3.

Two convenient references for Fréchet spaces and Fréchet manifolds are R. Hamilton [20] and A. Kriegl and P. Michor [41].

This is a good time to introduce some of our notational conventions. Spaces of mappings will usually have names beginning with capital letters, such as the diffeomorphism group  $\text{Diff}(M)$  or the space of embeddings  $\text{Emb}(V, M)$  of a submanifold of  $M$ . The same name beginning with a small letter, as in  $\text{diff}(M)$  or  $\text{emb}(V, M)$ , will indicate the path component of the identity or inclusion map. We also use  $I$  to denote the standard unit interval  $[0, 1]$ .

#### 2.1. The $C^\infty$ -topology

For now, let  $M$  be a manifold with empty boundary. Throughout our work, we will use the  $C^\infty$ -topology on  $\text{Diff}(M)$ . For this topology,  $\text{Diff}(M)$  is a Fréchet manifold, locally diffeomorphic to the Fréchet space  $\mathcal{Y}(M, TM)$  of smooth vector fields on  $M$ . In fact, the space  $C^\infty(M, N)$  of smooth maps from  $M$  to  $N$  is a Fréchet manifold, metrizable when  $M$  is compact (see for example Theorem 42.1 and Proposition 42.3 of [41]), and  $\text{Diff}(M)$  is an open subset of  $C^\infty(M, M)$  (Theorem 43.1 of [41]).

When  $M$  is compact, or more generally when one is working with maps and sections supported on a fixed compact subset of  $M$ ,  $\mathcal{Y}(M, TM)$  is a separable Fréchet space. By Theorem II.7.3 of [4], originally announced in [28], manifolds modeled on a separable Fréchet space  $Y$  are homeomorphic whenever they have the same homotopy type. Theorem IX.7.1 of [4] (originally Theorem 4 of [27]) shows

that  $\text{Diff}(M)$  admits an open embedding into  $Y$ . Theorems II.6.2 and II.6.3 of [4] then show that  $\text{Diff}(M)$  has the homotopy type of a CW-complex. (As far as we know, this fact is due originally to Palais [52]; he showed that many infinite-dimensional manifolds are dominated by CW-complexes, but a space dominated by a CW-complex is homotopy equivalent to some CW-complex [44, Theorem IV.3.8].)

## 2.2. Metrics which are products near the boundary

We are going to work extensively with manifolds with boundary, and will need special Riemannian metrics on them, which we develop in this section.

Recall that a Riemannian metric is called *complete* if every Cauchy sequence converges. For a complete Riemannian metric on  $M$ , a geodesic can be extended indefinitely unless it reaches a point in the boundary of  $M$ , where it may continue or it may fail to be extendible because it “runs out of the manifold.”

**DEFINITION 2.2.1.** A Riemannian metric on  $M$  is said to be a *product near the boundary* if there is a collar neighborhood  $\partial M \times I$  of the boundary on which the metric is the product of a complete metric on  $\partial M$  and the standard metric on  $I$ .

Note that when the metric is a product near the boundary, the exponential of any vector tangent to  $\partial M$  is a point in  $\partial M$ .

Given any collar  $\partial M \times [0, 2]$ , it is easy to obtain a metric that is a product near the boundary of  $M$ . On  $\partial M \times [0, 2)$ , fix a Riemannian metric that is the product of a metric on  $\partial M$  and the usual metric on  $[0, 2)$ . Obtain the metric on  $M$  from this metric and any metric defined on all of  $M$  by using a partition of unity subordinate to the open cover  $\{\partial M \times [0, 2), M - \partial M \times I\}$ .

By a submanifold  $V$  of  $M$ , we mean a smooth submanifold. When  $M$  has boundary and  $\dim(V) < \dim(M)$ , we always require that  $V$  be properly embedded in the sense that  $V \cap \partial M = \partial V$ , and that every inward pointing tangent vector to  $V$  at a point in  $\partial V$  be also inward pointing in  $M$ .

We will often work with codimension-0 submanifolds of bounded manifolds. In that case, the submanifold is a *manifold with corners*, that is, locally diffeomorphic to a product of half-lines and lines. In fact, all of our work should extend straightforwardly into the full context of manifolds with corners, but for simplicity we restrict to the cases we will need. When  $V$  has codimension 0, we require that the frontier of  $V$  be a codimension-1 submanifold of  $M$  as above.

DEFINITION 2.2.2. Suppose that the Riemannian metric on  $M$  is a product near the boundary, with respect to the collar  $\partial M \times I$ . A submanifold  $V$  of  $M$  is said to *meet the collar*  $\partial M \times I$  in I-fibers when  $V \cap \partial M \times I$  is a union of I-fibers of  $\partial M \times I$ .

Note that when  $V$  meets the collar of  $M$  in I-fibers, the normal space to  $V$  at any point  $(x, t)$  in  $\partial M \times I$  is contained in the subspace in  $T_x M$  tangent to  $\partial M \times \{t\}$ . Consequently, if one exponentiates the ( $< \epsilon$ )-length vectors in the normal bundle to obtain a tubular neighborhood of  $V$ , then the fiber at  $(x, t)$  is contained in  $\partial M \times \{t\}$ .

Given a submanifold  $V$ , one may obtain a complete metric on  $M$  that is a product near  $\partial M$  and such that  $V$  meets the collar  $\partial M \times I$  in I-fibers as follows. First, obtain a collar of  $\partial M$  that  $V$  meets in I-fibers, by constructing an inward-pointing vector field on a neighborhood of  $\partial M$  which is tangent to  $V$ , using the integral curves associated to the vector field to produce the collar, then carrying out the previous construction to obtain a metric that is a product near the boundary for this collar. It is complete on the collar. To make it complete on all of  $M$ , define  $f: M - \partial M \rightarrow (0, \infty)$  by putting  $f(x)$  equal to the supremum of the values of  $r$  such that  $\text{Exp}$  is defined on all vectors in  $T_x(M)$  of length less than  $r$ . Let  $g: M - \partial M \rightarrow (0, \infty)$  be a smooth map that is an  $\epsilon$ -approximation to  $1/f$ , and let  $\phi: M \rightarrow [0, 1]$  be a smooth map which is equal to 0 on  $\partial M \times I$  and is 1 on  $M - \partial M \times [0, 2)$ . Give  $M \times [0, \infty)$  the product metric, and define a smooth embedding  $i: M \rightarrow M \times [0, \infty)$  by  $i(x) = (x, \phi(x)g(x))$  if  $x \notin \partial M$  and  $i(x) = (x, 0)$  if  $x \in \partial M$ . The restricted metric on  $i(M)$  agrees with the product metric on  $\partial M \times I$  and is complete.

We will always assume that Riemannian metrics have been chosen to be complete.

### 2.3. Manifolds with boundary

In this section, we will extend the results of Section 2.1 to the bounded case. We always assume that  $M$  has a Riemannian metric which is a product near the boundary for some collar  $\partial M \times I$ .

DEFINITION 2.3.1. Let  $V$  be a submanifold of  $M$ . By  $\mathcal{Y}(V, TM)$  we denote the Fréchet space of all sections from  $V$  to the restriction of the tangent bundle of  $M$  to  $V$ . The zero section of  $\mathcal{Y}(V, TM)$  is denoted by  $Z$ . For  $L \subseteq M$ , we denote by  $\mathcal{Y}^L(V, TM)$  the subspace of  $\mathcal{Y}(V, TM)$  consisting of the sections which equal  $Z$  on  $V - L$ .

The following extension lemma will be useful.

LEMMA 2.3.2. *Form a manifold  $N$  from  $M$  and  $\partial M \times (-\infty, 0]$  by identifying  $\partial M$  with  $\partial M \times \{0\}$ , and extending the metric on  $M$  using the product of the complete metric on  $\partial M$  and the standard metric on  $(-\infty, 0]$ .*

- (i) *There is a continuous linear extension  $E: C^\infty(M, \mathbb{R}) \rightarrow C^\infty(N, \mathbb{R})$  for which the image is contained in the subspace of functions that vanish on  $\partial M \times (-\infty, -1]$ .*
- (ii) *There is a continuous linear extension  $E: \mathcal{Y}(M, TM) \rightarrow \mathcal{Y}(N, TN)$  for which the image is contained in the subspace of sections that vanish on  $\partial M \times (-\infty, -1]$ .*

PROOF. Part (i) is basically what is established in the proof of Corollary II.1.3.7 of [20]. It was also proven by essentially the same method, using series in place of integration and working only on a half-space in  $\mathbb{R}^n$ , by R. Seeley [61]. The extensions are first performed in local coordinates  $\mathbb{R}^{n-1} \times \mathbb{R}$ , where the value of the extension  $Ef(x, t)$  for  $t < 0$  is given by an integral on the ray  $\{x\} \times [0, \infty)$ . Fixing a collection of charts and a partition of unity, these local extensions are pieced together to give  $Ef$ . Multiplying by a smooth function which is 1 on a neighborhood of  $M$  and vanishes on  $\partial M \times (-\infty, -1]$ , we may achieve the final property in (i). Part (ii) follows from (i) since locally a vector field is just a collection of  $n$  real-valued functions.  $\square$

We are grateful to Tatsuhiko Yagasaki for bringing the reference [61] to our attention.

Our proof that  $\text{Diff}(M)$  is a Fréchet manifold will use the *tame exponential* TExp. Let  $X$  be a vector field on  $M$  such that for every  $x \in M$ ,  $\text{Exp}(X(x))$  is defined. Then  $\text{TExp}(X)$  is defined to be the map from  $M$  to  $M$  that takes each  $x$  to  $\text{Exp}(X(x))$ . For a complete manifold  $M$  without boundary, the tame exponential defines local charts on  $C^\infty(M, M)$  (and more generally on  $C^\infty(M, N)$  if instead of vector fields on  $M$  one uses sections of a pullback of  $TN$  to a bundle over  $M$ ), see for example Theorem 42.1 of [41].

DEFINITION 2.3.3. Let  $V$  be a submanifold of  $M$ , and as always assume that the metric on  $M$  is a product near the boundary and  $V$  meets  $\partial M \times I$  in  $I$ -fibers. By  $\mathcal{X}(V, TM)$  we denote the Fréchet subspace of  $\mathcal{Y}(V, TM)$  consisting of those sections which are tangent to  $\partial M$  at all points of  $V \cap \partial M$ . For  $L \subseteq M$ , we denote by  $\mathcal{X}^L(V, TM)$  the subspace of sections that equal  $Z$  on  $V - L$ .

We remark that  $\mathcal{X}(M, TM)$  is the tangent space at  $1_M$  of the infinite-dimensional Lie group  $\text{Diff}(M)$ , and the exponential map in that context takes a vector field on  $M$  to the map at time 1 of the flow

on  $M$  associated to the vector field. The resulting exponential map from  $\mathcal{X}(M, TM)$  to  $\text{Diff}(M)$  is not locally surjective near  $Z$  and  $1_M$ , even for  $M = S^1$  (see for example Section 5.5.2 of [20]). We will always use the tame exponential, which as noted above is a local homeomorphism (in fact, a local diffeomorphism, for appropriate structures on these spaces as infinite-dimensional manifolds).

We can now give the Fréchet structure on  $\text{Diff}(M)$ . We will denote by  $C^\infty((M, \partial M), (M, \partial M))$  the space of smooth maps from  $M$  to  $M$  that take  $\partial M$  to  $\partial M$ , with the  $C^\infty$ -topology.

**THEOREM 2.3.4.** *The space  $C^\infty((M, \partial M), (M, \partial M))$  is a Fréchet manifold locally modeled on  $\mathcal{X}(M, TM)$ , and  $\text{Diff}(M)$  is an open subset of  $C^\infty((M, \partial M), (M, \partial M))$ .*

**PROOF.** It suffices to find a local chart for  $C^\infty((M, \partial M), (M, \partial M))$  at the identity  $1_M$  that has image in  $\text{Diff}(M)$ . Form a manifold  $N$  from  $M$  as in Lemma 2.3.2, and let  $E: \mathcal{Y}(M, TM) \rightarrow \mathcal{Y}(N, TN)$  be a continuous linear extension as in part (ii) of Lemma 2.3.2. Since  $N$  is complete, the tame exponential  $\text{TExp}: \mathcal{Y}(N, TN) \rightarrow C^\infty(N, N)$  is defined. From Theorem 43.1 of [41],  $\text{Diff}(N)$  is an open subset of  $C^\infty(N, N)$ . Let  $U \subset \mathcal{Y}(N, TN)$  be an open neighborhood of  $Z$  which  $\text{TExp}$  carries homeomorphically to an open neighborhood of  $1_N$  in  $\text{Diff}(N)$ . Since vector fields in  $\mathcal{X}(M, TM)$  are tangent to the boundary,  $\text{TExp}$  carries  $U \cap E(\mathcal{X}(M, TM))$  to diffeomorphisms of  $N$  taking  $\partial M$  to  $\partial M$ . Therefore  $\text{TExp}$  carries the open neighborhood  $E^{-1}(U \cap E(\mathcal{X}(M, TM)))$  of  $Z$  into  $\text{Diff}(M)$ .  $\square$

As in the case of manifolds without boundary, we can now conclude that  $\text{Diff}(M)$  has the homotopy type of a CW-complex.

When  $M$  is compact,  $\text{Diff}(M)$  is separable, and moreover  $\text{Diff}(M)$  is locally convex. Explicitly, our local charts defined using the tame exponential show that for any  $f \in \text{Diff}(M)$ , there is a neighborhood  $U$  of  $f$  such that for every  $g \in U$ , the homotopy that moves points along the shortest geodesic from each  $g(x)$  to  $f(x)$  is an isotopy from  $g$  to  $f$ .

For a closed subset  $X \subset M$ , we denote by  $\text{Diff}(M \text{ rel } X)$  the subgroup of  $\text{Diff}(M)$  consisting of the elements which take  $X$  to  $X$  and restrict to the identity map on  $X$ . Adapting the previous arguments shows that  $\text{Diff}(M \text{ rel } X)$  is modeled on the closed Fréchet subspace of  $\mathcal{X}(M, TM)$  consisting of sections that vanish on  $X$ .

## 2.4. Spaces of embeddings

When we work with embeddings, we always start with a fixed submanifold  $V$  of the ambient manifold  $M$ . The inclusion map then furnishes a natural basepoint of the space of imbeddings. In addition, this will allow a simple definition of the space of images of  $V$  in  $M$ , given in Definition 3.2.1 below.

**DEFINITION 2.4.1.** Let  $V$  be a submanifold of  $M$ . When  $M$  has boundary and  $\dim(V) < \dim(M)$ , we always require that  $V \cap \partial M = \partial V$ , and select our Riemannian metric on  $M$  to be a product near the boundary for which  $V$  meets the collar  $\partial M \times I$  in  $I$ -fibers. Similarly, when  $V$  is codimension-0, the frontier of  $V$  is a codimension-1 submanifold of  $M$  assumed to meet  $\partial M \times I$  in  $I$ -fibers. Denote by  $\text{Emb}(V, M)$  the space of all smooth embeddings  $j$  of  $V$  into  $M$  such that

- (i)  $j^{-1}(\partial M) = V \cap \partial M$ , and
- (ii)  $j$  extends to a diffeomorphism from  $M$  to  $M$ .

Note that condition (ii) implies that  $j$  carries every inward-pointing tangent vector of  $V \cap \partial M$  to an inward-pointing tangent vector of  $M$ . It also implies that the natural map  $\text{Diff}(M) \rightarrow \text{Emb}(V, M)$  that sends each diffeomorphism to its restriction to  $V$  is surjective.

With the  $C^\infty$ -topology,  $\text{Emb}(V, M)$  is a Fréchet manifold locally modeled on  $\mathcal{X}(V, TM)$ . For the closed case, this is proven in Theorem 44.1 of [41], and adaptations like those in Section 2.3 allow its extension in the bounded and codimension-0 contexts (note that Lemma 2.3.2 provides a continuous linear extension from  $\mathcal{X}(V, M)$  to  $\mathcal{X}(V \cup (-\infty, 0], M \cup (-\infty, 0])$ ). As in the case of  $\text{Diff}(M)$ , this Fréchet manifold structure shows that  $\text{Emb}(V, M)$  has the homotopy type of a CW-complex.

## 2.5. Bundles and fiber-preserving diffeomorphisms

Let  $p: E \rightarrow B$  be a locally trivial smooth map of manifolds, with compact fiber. When  $B$  and the fiber have nonempty boundary,  $E$  should be regarded as a manifold with corners at the boundary points of the fibers in  $p^{-1}(\partial B)$ . The horizontal boundary  $\partial_h E$  is defined to be  $\cup_{x \in B} \partial(p^{-1}(x))$ , and the vertical boundary  $\partial_v E$  to be  $p^{-1}(\partial B)$ .

**DEFINITION 2.5.1.** The space of *fiber-preserving diffeomorphisms* is the subspace  $\text{Diff}_f(E)$  of  $\text{Diff}(E)$  consisting of the diffeomorphisms that take each fiber of  $E$  to a fiber. The *vertical diffeomorphisms*  $\text{Diff}_v(E)$  are the elements of  $\text{Diff}_f(E)$  that take each fiber to itself.

Fibered submanifolds also play an important role.

DEFINITION 2.5.2. A submanifold  $W$  of  $E$  is called *fibered* or *vertical* if it is a union of fibers. For a fibered submanifold  $W$  of  $E$ , define  $\partial_h W$  to be  $W \cap \partial_h E$  and  $\partial_v W$  to be  $W \cap \partial_v E$ . The space of *fiber-preserving embeddings*  $\text{Emb}_f(W, E)$  is the subspace of  $\text{Emb}(W, E)$  consisting of embeddings that take each fiber of  $W$  to a fiber of  $E$ , and the space of *vertical embeddings*  $\text{Emb}_v(W, E)$  is the subspace of  $\text{Emb}_f(W, E)$  consisting of embeddings taking each fiber to itself.

At each point  $x \in E$ , let  $V_x(E)$  denote the *vertical subspace* of  $T_x(E)$  consisting of vectors tangent to the fiber of  $p$ . When  $E$  has a Riemannian metric, the orthogonal complement  $H_x(E)$  of  $V_x(E)$  in  $T_x(E)$  is called the *horizontal subspace*. We call the elements of  $V_x(E)$  and  $H_x(E)$  *vertical* and *horizontal* respectively. Clearly  $V_x(E)$  is the kernel of  $p_*: T_x(E) \rightarrow T_{p(x)}(B)$ , while  $p_*|_{H_x(E)}: H_x(E) \rightarrow T_{p(x)}(B)$  is an isomorphism. Each vector  $\omega \in T_x(E)$  has an orthogonal decomposition  $\omega = \omega_v + \omega_h$  into its vertical and horizontal parts.

A path  $\alpha$  in  $E$  is called *horizontal* if  $\alpha'(t) \in H_{\alpha(t)}(E)$  for all  $t$  in the domain of  $\alpha$ . Let  $\gamma: [a, b] \rightarrow B$  be a path such that  $\gamma'(t)$  never vanishes, and let  $x \in E$  with  $p(x) = \gamma(a)$ . A horizontal path  $\tilde{\gamma}: [a, b] \rightarrow E$  such that  $\tilde{\gamma}(a) = x$  and  $p\tilde{\gamma} = \gamma$  is called a *horizontal lift* of  $\gamma$  starting at  $x$ .

To ensure that horizontal lifts exist, we will need a special metric on  $E$ .

DEFINITION 2.5.3. A Riemannian metric on  $E$  is said to be a *product near  $\partial_h E$*  when

- (i) There is a collar neighborhood  $\partial_h E \times I$  of the horizontal boundary on which the metric is the product of a complete metric on  $\partial_h E$  and the standard metric on  $I$ ,
- (ii) For this collar  $\partial_h E \times I$ , each  $\{x\} \times I$  lies in some fiber of  $p$ .

Such metrics can be constructed using a partition of unity as follows. Using the local product structure, at each point  $x$  in  $\partial_h E$  select a vector field defined on a neighborhood of  $x$  that

- (a) points into the fiber at points of  $\partial_h E$ , and
- (b) is tangent to the fibers wherever it is defined.

By (b), the vector field must be tangent to  $\partial_v E$  at points in  $\partial_v E$ . Since scalar multiples and linear combinations of vectors satisfying these two conditions also satisfy them, we may piece these local fields together using a partition of unity to construct a vector field, nonvanishing on a neighborhood of  $\partial_h E$ , that satisfies (a) and (b). Using the integral curves associated to this vector field we obtain a smooth collar neighborhood  $\partial_h E \times [0, 2]$  of  $\partial_h E$  such that each  $[0, 2]$ -fiber lies in a fiber of  $p$ . On  $\partial_h E \times [0, 2]$ , fix a Riemannian metric that is the product of

a metric on  $\partial_h E$  and the usual metric on  $[0, 2)$ . Form a metric on  $E$  from this metric and any metric on all of  $E$  using a partition of unity subordinate to the open cover  $\{\partial_h E \times [0, 2), E - \partial_h E \times I\}$ .

When the metric is a product near  $\partial_h E$  such that the I-fibers of  $\partial_h E \times I$  are vertical, the horizontal subspace  $H_x$  is tangent to  $\partial_h E \times \{t\}$  whenever  $x \in \partial_h E \times \{t\}$ . For  $H_x$  is orthogonal to the fiber  $p^{-1}(p(x))$ , and since the I-fiber of  $\partial_h E \times I$  that contains  $x$  lies in  $p^{-1}(p(x))$ ,  $H_x$  is orthogonal to that I-fiber as well. Since  $\partial_h E \times \{t\}$  meets the I-fiber orthogonally, with codimension 1,  $H_x$  is tangent to  $\partial_h E \times \{t\}$ .

Since the horizontal subspaces are tangent to the  $\partial_h E \times \{t\}$ , a horizontal lift starting in some  $\partial_h E \times \{t\}$  will continue in  $\partial_h E \times \{t\}$ . Provided that the fiber is compact, as we are assuming, the existence of horizontal lifts is assured.

## 2.6. Aligned vector fields and the aligned exponential

DEFINITION 2.6.1. A vector field  $X: E \rightarrow TE$  is called *aligned* if  $p(x) = p(y)$  implies that  $p_*(X(x)) = p_*(X(y))$  (these are often called *projectable* in the literature). This happens precisely when there exist a vector field  $X_B$  on  $B$  and a vertical vector field  $X_V$  on  $E$  so that for all  $x \in E$ ,

$$X(x) = (p_*|_{H_x})^{-1}(X_B(p(x))) + X_V(x) .$$

In particular, any vertical vector field is aligned. When  $X$  is aligned, the projected vector field  $p_*X$  is well-defined.

The idea of the aligned exponential  $\text{Exp}_a$  is that it behaves as would the regular exponential if the metric on  $E$  were locally the product of a metric on  $F$  and a metric on  $B$ . The key property of  $\text{Exp}_a$  is that if  $X$  is an aligned vector field on  $E$ , and  $\text{Exp}_a(X(x))$  is defined for all  $x$ , then the map of  $E$  defined by sending  $x$  to  $\text{Exp}_a(X(x))$  will be fiber-preserving.

DEFINITION 2.6.2. Let  $\pi: TE \rightarrow E$  denote the tangent bundle of  $E$ . Assume that the metric on  $E$  is a product near  $\partial_h E$  such that the I-fibers of  $\partial_h E \times I$  are vertical. Each fiber  $F$  of  $E$  inherits a Riemannian metric from that of  $E$ , and has an exponential map  $\text{Exp}_F$  which (where defined) carries vectors tangent to  $F$  to points of  $F$ . The path  $\text{Exp}_F(t\omega)$  is not generally a geodesic in  $E$ . The *vertical exponential*  $\text{Exp}_v$  is defined by  $\text{Exp}_v(\omega) = \text{Exp}_F(\omega)$ , where  $\omega$  is a vertical vector and  $F$  is the fiber containing  $\pi(\omega)$ . The *aligned exponential map*  $\text{Exp}_a$  is defined as follows. Consider a tangent vector  $\omega \in T_x(E)$  such that for the vector  $p_*(\omega) \in T_{p(x)}(B)$ ,  $\text{Exp}(p_*(\omega))$  is defined. A geodesic segment  $\gamma_{p_*(\omega)}$  starting at  $p(\pi(\omega))$  is defined by  $\gamma_{p_*(\omega)}(t) = \text{Exp}(tp_*(\omega))$ ,  $0 \leq t \leq 1$ .



Define  $\text{Exp}_a(\omega)$  to be the endpoint of the unique horizontal lift of  $\gamma_{p_*(\omega)}$  starting at  $\text{Exp}_v(\omega_v)$ .

Note that  $\text{Exp}_a(\omega)$  exists if and only if both  $\text{Exp}_v(\omega_v)$  and  $\text{Exp}(p_*(\omega))$  exist. Clearly, when  $\text{Exp}_a(\omega)$  is defined, it lies in the fiber containing the endpoint of a lift of  $\gamma_{p_*(\omega)}$ , and therefore  $p(\text{Exp}_a(\omega)) = \text{Exp}(p_*(\omega))$ . This immediately implies that if  $X$  is an aligned vector field on  $E$  such that  $\text{Exp}_a(X(x))$  is defined for all  $x \in E$ , then the map defined by sending  $x$  to  $\text{Exp}_a(X(x))$  takes fibers to fibers, and in particular if  $X$  is vertical, it takes each fiber to itself.

**DEFINITION 2.6.3.** Let  $W$  be a vertical submanifold of  $E$ . By  $\mathcal{A}(W, TE)$  we denote the Fréchet space of sections  $X$  from  $W$  to  $TE|_W$  such that

- (1)  $X$  is aligned, that is, if  $p(w_1) = p(w_2)$  then  $p_*(X(w_1)) = p_*(X(w_2))$ ,
- (2) if  $x \in \partial_h W$ , then  $X(x)$  is tangent to  $\partial_h E$ , and if  $x \in \partial_v W$ , then  $X(x)$  is tangent to  $\partial_v E$ , and

The elements of  $\mathcal{A}(W, TE)$  such that  $p_*X(x) = Z(p(x))$  for all  $x \in W$  are denoted by  $\mathcal{V}(W, TE)$ .

By condition (3),  $\text{TExp}_a(X)$  is defined for every  $X$  in  $\mathcal{A}(W, TE)$  or in  $\mathcal{V}(W, TE)$ .

The vector space structure on  $\mathcal{A}(W, TE)$  is defined using the vector space structures of the fibers of  $TE$  and  $TB$ . Given  $v, w \in \mathcal{A}(W, TE)$ , we decompose them into their vertical and horizontal parts. The vertical parts are added by the usual addition in  $TE$ . The horizontal parts are added by pushing down to  $TB$ , adding there, and taking horizontal lifts.

Since horizontal lifts of geodesics in  $B$  exist,  $\text{Exp}_a(\omega)$  is defined whenever  $\text{Exp}_v(\omega)$  and  $\text{Exp}(p_*(\omega))$  are defined. In particular, the tame aligned exponential  $\text{TExp}_a$  carries a neighborhood of  $Z$  in  $\mathcal{A}(W, TE)$  into  $C_f^\infty(W, E)$ . Choosing the neighborhood small enough to ensure that  $\text{TExp}_a(X) \in \text{Emb}_f(W, E)$  provides local charts on  $\text{Emb}_f(W, E)$ , that carry the vertical fields into  $\text{Emb}_v(W, E)$ . Thus we have:

**THEOREM 2.6.4.** *The spaces  $\text{Diff}_f(E)$ ,  $\text{Diff}_v(E)$ ,  $\text{Emb}_f(W, E)$ , and  $\text{Emb}_v(W, E)$  are infinite-dimensional manifolds modeled on Fréchet spaces of aligned vector fields.*



## CHAPTER 3

### The method of Cerf and Palais

In [51], R. Palais proved a very useful result relating diffeomorphisms and embeddings. For closed  $M$ , it says that if  $W \subseteq V$  are submanifolds of  $M$ , then the mappings  $\text{Diff}(M) \rightarrow \text{Emb}(V, M)$  and  $\text{Emb}(V, M) \rightarrow \text{Emb}(W, M)$  obtained by restricting diffeomorphisms and embeddings are locally trivial, and hence are Serre fibrations. The same results, with variants for manifolds with boundary and more complicated additional boundary structure, were proven by J. Cerf in [10]. Among various applications of these results, the Isotopy Extension Theorem follows by lifting a path in  $\text{Emb}(V, M)$  starting at the inclusion map of  $V$  to a path in  $\text{Diff}(M)$  starting at  $1_M$ . Moreover, parameterized versions of isotopy extension follow just as easily from the homotopy lifting property for  $\text{Diff}(M) \rightarrow \text{Emb}(V, M)$  (see Corollary 3.3.7).

In this chapter, we will extend the theorem of Palais in various ways. Many of our results concern fiber-preserving maps. For example, in Section 3.3 we will prove the

**Projection Theorem** (Theorem 3.3.6) *Let  $E$  be a bundle over a compact manifold  $B$ . Then  $\text{Diff}_f(E) \rightarrow \text{Diff}(B)$  is locally trivial.*

This should be considered a folk theorem. Below we will discuss some of its antecedents.

The homotopy extension property for the projection fibration  $\text{Diff}_f(E) \rightarrow \text{Diff}(B)$  translates directly into the following.

**Parameterized Isotopy Lifting Theorem** (Corollary 3.3.7) **Suppose that  $p: E \rightarrow B$  is a fibering of compact manifolds, and suppose that for each  $t$  in a path-connected parameter space  $P$ , there is an isotopy  $g_{t,s}$  such that  $g_{t,0}$  lifts to a diffeomorphism  $G_{t,0}$  of  $E$ . Assume that sending  $(t, s) \rightarrow g_{t,s}$  defines a continuous function from  $P \times [0, 1]$  to  $\text{Diff}(B)$  and sending  $t$  to  $G_{t,0}$  defines a continuous function from  $P$  to  $\text{Diff}_f(E)$ . Then the family  $G_{t,0}$  extends to a continuous family on  $P \times I$  such that for each  $(t, s)$ ,  $G_{t,s}$  is a fiber-preserving diffeomorphism inducing  $g_{t,s}$  on  $B$ .**

For fiber-preserving and vertical embeddings of vertical submanifolds, we have a more direct analogue of Palais' results.

**Restriction Theorem** (Corollaries 3.4.2 and 3.4.3) *Let  $V$  and  $W$  be vertical submanifolds of  $E$  with  $W \subseteq V$ , each of which is either properly embedded or codimension-zero. Then the restrictions  $\text{Diff}_f(M) \rightarrow \text{Emb}_f(V, M)$ ,  $\text{Diff}_v(M) \rightarrow \text{Emb}_v(V, M)$ ,  $\text{Emb}_f(V, E) \rightarrow \text{Emb}_f(W, E)$  and  $\text{Emb}_v(V, E) \rightarrow \text{Emb}_v(W, E)$  are locally trivial.*

As shown in Theorem 3.4.4, the Projection and Restriction Theorems can be combined into a single commutative square, called the *projection-restriction square*, in which all four maps are locally trivial:

$$\begin{array}{ccc} \text{Diff}_f(E) & \longrightarrow & \text{Emb}_f(W, E) \\ \downarrow & & \downarrow \\ \text{Diff}(B) & \longrightarrow & \text{Emb}(p(W), B) . \end{array}$$

In 3-dimensional topology, a key role is played by manifolds admitting a more general kind of fibered structure, called a Seifert fibering. Some general references for Seifert-fibered 3-manifolds are [26, 37, 38, 49, 50, 60, 62, 69, 70]. In Section 3.6, we prove the analogues of the results discussed above for most Seifert fiberings  $p: \Sigma \rightarrow \mathcal{O}$ . Actually, we work in a somewhat more general context, called *singular fiberings*, which resemble Seifert fiberings but for which none of the usual structure of the fiber as a homogeneous space is required.

In the late 1970's fibration results akin to our Projection Theorem for the singular fibered case were proven by W. Neumann and F. Raymond [48]. They were interested in the case when  $\Sigma$  admits an action of the  $k$ -torus  $T^k$  and  $\Sigma \rightarrow \mathcal{O}$  is the quotient map to the orbit space of the action. They proved that the space of (weakly)  $T^k$ -equivariant homeomorphisms of  $\Sigma$  fibers over the space of homeomorphisms of  $\mathcal{O}$  that respect the orbit types associated to the points of  $\mathcal{O}$ . A detailed proof of this result when the dimension of  $\Sigma$  is  $k + 2$  appears in the dissertation of C. Park [53]. Park also proved analogous results for space of weakly  $G$ -equivariant maps for principal  $G$ -bundles and for Seifert fiberings of arbitrary dimension [53, 54]. These results do not directly overlap ours since we always consider the full group of fiber-preserving diffeomorphisms without any restriction to  $G$ -equivariant maps (indeed, no assumption of a  $G$ -action is even present).

The results of this chapter will be used heavily in the later chapters. In this chapter, we give one main application. For a Seifert-fibered manifold  $\Sigma$ ,  $\text{Diff}(\Sigma)$  acts on the set of Seifert fiberings, and the stabilizer of the given fibering is  $\text{Diff}_f(\Sigma)$ , thus the space of cosets  $\text{Diff}(\Sigma)/\text{Diff}_f(\Sigma)$  can be regarded as the *space of Seifert fiberings* of  $\Sigma$

equivalent to the given one. We prove in Section 3.9 that for a Seifert-fibered Haken 3-manifold, each component of the space of Seifert fiberings is contractible (apart from a small list of well-known exceptions, the space of Seifert fiberings is connected). This too should be considered a folk result; it appears to be widely believed and regarded to be a direct consequence of the work of Hatcher and Ivanov on the diffeomorphism groups of Haken manifolds. We have found, however, that a real proof requires more than a little effort.

Our results will be proven by adapting the Palais method of [51], using the aligned exponential defined in Section 2.6. In Section 3.1, we reprove the main result of [51] for manifolds which may have boundary. This duplicates [10] (in fact, the boundary control there is more refined than ours), but is included to furnish lemmas as well as to exhibit a prototype for the approach we use to deal with the bounded case in our later settings. In Section 3.5, we give the analogues of the results of Palais and Cerf for smooth orbifolds, which for us are quotients  $\tilde{\mathcal{O}}/H$  where  $\tilde{\mathcal{O}}$  is a manifold and  $H$  is a group acting smoothly and properly discontinuously on  $\tilde{\mathcal{O}}$ . Besides being of independent interest, these analogues are needed for the case of singular fiberings.

Throughout this chapter, all Riemannian metrics are assumed to be products near the boundary, or near the horizontal boundary for total spaces of bundles, such that any submanifolds under consideration meet the collars in I-fibers. Let  $V$  be a submanifold of  $M$ . As in Definition 2.3.3, the notation  $\mathcal{X}(V, TM)$  means the Fréchet space of sections from  $V$  to the restriction of the tangent bundle of  $M$  to  $V$  that are tangent to  $\partial M$  at all points of  $V \cap \partial M$ . We also utilize various kinds of control, as indicated in the following definitions.

**DEFINITION 3.0.5.** The notations  $\text{Diff}(M \text{ rel } X)$  and  $\text{Diff}^{M-X}(M)$  mean the space of diffeomorphisms which restrict to the identity map on each point of the subset  $X$  of  $M$ . These notations may be combined, for example  $\text{Diff}^L(M \text{ rel } X)$  is the space of diffeomorphisms that are the identity on  $X \cup (M - L)$ .

**DEFINITION 3.0.6.** For  $X \subseteq M$  we say that  $K \subseteq M$  is a neighborhood of  $X$  when  $X$  is contained in the topological interior of  $K$ . If  $K$  is a neighborhood of a submanifold  $V$  of  $M$ , then  $\text{Emb}^K(V, M)$  means the elements  $j$  in  $\text{Emb}(V, M)$  such that  $K$  is a neighborhood of  $j(V)$ . Suppose that  $S$  is a closed neighborhood in  $\partial M$  of  $V \cap \partial M$ . Note that this implies that  $S \cap \partial V$  is a union of components of  $V \cap \partial M$ . We denote by  $\text{Emb}(V, M \text{ rel } S)$  the elements  $j$  that equal the inclusion on  $V \cap S$  and carry  $V \cap (\partial M - S)$  into  $\partial M - S$ . For a neighborhood  $K$

of  $V$ , the superscript notation of Definition 3.0.5 may be used, as in  $\text{Emb}^K(V, M \text{ rel } S)$ .

DEFINITION 3.0.7. Recall from Definition 2.3.3 that for  $L \subseteq M$ ,  $\mathcal{X}^L(V, TM)$  means the elements of  $\mathcal{X}(V, TM)$  that equal the zero section  $Z$  on  $V-L$ . We extend this to the aligned and vertical sections (see Definition 2.6.3), so that if  $L \subset E$  then  $\mathcal{A}^L(W, TE)$  and  $\mathcal{V}^L(W, TE)$  and  $\mathcal{V}^L(W, TE)$  have the corresponding meanings.

### 3.1. The Palais-Cerf Restriction Theorem

We begin with a review of the method of Palais [51].

DEFINITION 3.1.1. Let  $X$  be a  $G$ -space and  $x_0 \in X$ . A *local cross-section* (or  *$G$  local cross-section*) for  $X$  at  $x_0$  is a map  $\chi$  from a neighborhood  $U$  of  $x_0$  into  $G$  such that  $\chi(u)x_0 = u$  for all  $u \in U$ . By replacing  $\chi(u)$  by  $\chi(u)\chi(x_0)^{-1}$ , one may always assume that  $\chi(x_0) = 1_G$ . If  $X$  admits a local cross-section at each point, it is said to admit local cross-sections.

Note that a local cross-section  $\chi_0: U_0 \rightarrow G$  at a single point  $x_0$  determines a local cross section  $\chi: gU_0 \rightarrow G$  at any point  $gx_0$  in the orbit of  $x_0$ , by the formula  $\chi(u) = g\chi_0(g^{-1}u)g^{-1}$ , since then  $\chi(u)(gx_0) = g\chi_0(g^{-1}u)g^{-1}gx_0 = g\chi_0(g^{-1}u)x_0 = gg^{-1}u = u$ . In particular, if  $G$  acts transitively on  $X$ , then a local cross section at any point provides local cross sections at all points.

From [51] we have

PROPOSITION 3.1.2. *Let  $G$  be a topological group and  $X$  a  $G$ -space admitting local cross-sections. Then any equivariant map of a  $G$ -space into  $X$  is locally trivial.*

In fact, when  $\pi: Y \rightarrow X$  is  $G$ -equivariant, the local coordinates on  $\pi^{-1}(U)$  are just given by sending the point  $(u, z) \in U \times \pi^{-1}(y_0)$  to  $\chi(u) \cdot z$ . Some additional properties of the bundles obtained in Proposition 3.1.2 are given in [51].

EXAMPLE 3.1.3. For a closed subgroup  $H$  of a Lie group  $G$ , the projection  $G \rightarrow G/H$  to the space of left cosets of  $H$  always has local  $G$  cross-sections, and hence is locally trivial. To check this, recall first that since  $G$  acts transitively on  $G/H$ , it is sufficient to find a local cross-section  $\chi_0$  at the coset  $eH$ , where  $e$  is the identity element of  $G$ . To construct  $\chi_0$ , fix a Riemannian metric on  $G$ . The tangent space  $T_eH$  is a subspace of  $T_eG$ . Let  $W$  be a complementary subspace. Let  $V$  be an open neighborhood of 0 in  $T_eG$  such that  $\text{Exp}: V \rightarrow U$  is a diffeomorphism onto an open neighborhood of  $e$  in  $G$ , and so that the

submanifold  $\text{Exp}(W \cap V)$  is transverse to the cosets  $uH$  for all  $u \in U$ . Defining  $\chi_0(uH)$  to be  $\text{Exp}(w)$  for the unique element  $w \in W \cap U$  such that  $\text{Exp}(w)U = uH$  gives the local cross-section at  $e$ .

The following technical lemma will simplify some of our applications of Proposition 3.1.2.

**PROPOSITION 3.1.4.** *Let  $M$  be a  $G$ -space and let  $V$  be a subspace of  $M$ , possibly equal to  $M$ . Let  $I(V, M)$  be a space of embeddings of  $V$  into  $M$ , on which  $G$  acts by composition on the left. Suppose that for every  $i \in I(V, M)$ , the space of embeddings  $I(i(V), M)$  has a local  $G$  cross-section at the inclusion map of  $i(V)$  into  $M$ . Then  $I(V, M)$  has local  $G$  cross-sections.*

**PROOF.** Fix  $i \in I(V, M)$ , and denote by  $j_{i(V)}$  the inclusion map of  $i(V)$  into  $M$ . Define  $Y: I(V, M) \rightarrow I(i(V), M)$  by  $Y(j) = ji^{-1}$ . For a local cross-section  $\chi: U \rightarrow G$  at  $j_{i(V)}$ , define  $Y_1$  to be the restriction of  $Y$  to  $Y^{-1}(U)$ , a neighborhood of  $i$  in  $I(V, M)$ . Then  $\chi Y_1: Y^{-1}(U) \rightarrow G$  is a local cross-section for  $I(V, M)$  at  $i$ . For if  $j \in Y^{-1}(U)$ , then  $\chi(Y_1(j)) \circ i = \chi(Y_1(j)) \circ j_{i(V)} \circ i = Y_1(j) \circ i = j$ .  $\square$

In our context, a typical procedure for finding a local cross-section using the Palais method is as follows. Suppose, for example, that one wants to find a local cross-section from a space of embeddings of a submanifold to a space of diffeomorphisms of the ambient manifold. First, take the “logarithm” of an embedding  $j$ , that is, find a section from the submanifold to the tangent bundle of  $M$  so that the exponential of the vector at each  $x$  is the image  $j(x)$ . Then obtain an “extension” of this section to a vector field on  $M$ . Finally, “exponentiate” the extended vector field to obtain the diffeomorphism of  $M$  that agrees with  $j$  on the submanifold. The extension process must be canonical enough so that sending the embedding to the resulting diffeomorphism is a local cross-section.

This three-step procedure depends in large part on three lemmas, or appropriate versions of them, called Lemmas d, c and b in [51]. As our first instance of them, we give the following versions for manifolds with boundary and submanifolds that may be of codimension 0.

**LEMMA 3.1.5 (Logarithm Lemma).** *Assume that the metric on  $M$  is a product near  $\partial M$ , and let  $V$  be a compact submanifold of  $M$  that meets  $\partial M \times I$  in  $I$ -fibers. Then there are an open neighborhood  $U$  of the inclusion  $i_V$  in  $\text{Emb}(V, M)$  and a continuous map  $X: U \rightarrow \mathcal{X}(V, TM)$  such that for all  $j \in U$ ,  $\text{Exp}(X(j)(x))$  is defined for all  $x \in V$  and  $\text{Exp}(X(j)(x)) = j(x)$  for all  $x \in V$ . Moreover,  $X(i_V) = Z$ .*

PROOF. Choose  $\epsilon$  small enough so that for all  $x \in V$ ,  $\text{Exp}$  carries the  $\epsilon$ -ball about 0 in  $T_x(M)$  (that is, the portion of this  $\epsilon$ -ball on which it is defined, which may be as small as a closed half-ball for  $x \in \partial M$ ) diffeomorphically to a neighborhood  $W_x$  of  $x$  in  $M$ . Choose a neighborhood  $U$  of  $i_V$  in  $\text{Emb}(V, M)$  so that if  $j \in U$  then  $j(x) \in W_x$ . For  $j \in U$  define  $X(j)(x)$  to be the unique vector in  $T_x(M)$  of length less than  $\epsilon$  for which  $\text{Exp}(X(j)(x))$  equals  $j(x)$ . Since the metric is a product near the boundary,  $X(j)$  is in  $\mathcal{X}(V, M)$ , and the remark about  $i_V$  is clear.  $\square$

The Extension Lemma uses the notation from Definition 3.0.7.

LEMMA 3.1.6 (Extension Lemma). *Assume that the metric on  $M$  is a product near  $\partial M$ , and let  $V$  be a compact submanifold of  $M$  that meets  $\partial M \times I$  in  $I$ -fibers. Let  $L$  be a neighborhood of  $V$  in  $M$ . Then there exists a continuous linear map  $k: \mathcal{X}(V, TM) \rightarrow \mathcal{X}^L(M, TM)$  such that  $k(X)(x) = X(x)$  for all  $x$  in  $V$  and all  $X$  in  $\mathcal{X}(V, TM)$ , and moreover if  $S$  is a closed neighborhood in  $\partial M$  of  $S \cap \partial V$ , and if  $X(x) = Z(x)$  for all  $x \in S \cap \partial V$ , then  $k(X)(x) = Z(x)$  for all  $x \in S$ .*

PROOF. Suppose first that  $V$  has positive codimension. Let  $\nu_\epsilon(V)$  denote the subspace of the normal bundle of  $V$  consisting of vectors of length  $\epsilon$ , and let  $e: \nu_\epsilon(V) \rightarrow M$  be the exponentiation map. For  $\epsilon$  sufficiently small,  $e$  is a diffeomorphism onto a tubular neighborhood of  $V$  in  $M$ . Since the metric on  $M$  is a product near the boundary, and  $V$  meets  $\partial M \times I$  in  $I$ -fibers, the fibers of  $\nu_\epsilon(V)$  are carried into the submanifolds  $\partial M \times \{t\}$  near the boundary.

Suppose that  $v \in T_x(M)$  and that  $\text{Exp}(v)$  is defined. For all  $u \in T_x(M)$  define  $P(u, v)$  to be the vector that results from parallel translation of  $u$  along the path that sends  $t$  to  $\text{Exp}(tv)$ ,  $0 \leq t \leq 1$ . In particular,  $P(u, Z(x)) = u$  for all  $u$ . Let  $\alpha: M \rightarrow [0, 1]$  be a smooth function which is identically 1 on  $V$  and identically 0 on  $M - e(\nu_{\epsilon/2}(V))$ . Define  $k: \mathcal{X}(V, TM) \rightarrow \mathcal{X}^L(M, TM)$  by

$$k(X)(x) = \begin{cases} \alpha(x)P(X(\pi(e^{-1}(x))), e^{-1}(x)) & \text{for } x \in e(\nu_\epsilon(V)) \\ Z(x) & \text{for } x \in M - e(\nu_{\epsilon/2}(V)) \end{cases}$$

For  $x \in V$ ,  $e^{-1}(x) = Z(x)$  and  $\alpha(x) = 1$ , so  $k(X)(x) = X(x)$ . Similarly,  $k(X)(x) = Z(x)$  for  $x \in M - L$ . For  $x \in \partial M$ ,  $\pi(e^{-1}(x))$  is also in  $\partial M$ , so  $X(\pi(e^{-1}(x)))$  is tangent to the boundary. Since the metric is a product near the boundary,  $P(X(\pi(e^{-1}(x))), e^{-1}(x))$  is also tangent to the boundary. Therefore  $k(X) \in \mathcal{X}^L(M, TM)$ .



Assume now that  $V$  has codimension zero, so that its frontier  $W$  is a properly embedded submanifold. Fix a tubular neighborhood  $W \times (-\infty, \infty)$ , contained in  $L$ , with  $V \cap (W \times (-\infty, \infty)) = W \times [0, \infty)$ . As in Lemma 2.3.2, there is a continuous linear extension map  $E: \mathcal{X}(V, TM) \rightarrow \mathcal{Y}(V \cup (W \times (-\infty, \infty)), TM)$ . Note that since  $M$  may have boundary, it is necessary to use the half-space version of reference [61] at points of  $V \cap \partial M$ . The extended vector fields are  $Z$  on  $W \times [1, \infty)$ , so extend using  $Z$  on  $M - (V \cup (W \times (-\infty, \infty)))$ . At points of  $\partial M$ , the component of each vector in the direction perpendicular to  $\partial M$  is 0, so since  $E$  is linear, the extended component is also 0 and therefore the extended vector field is also tangent to the boundary. This defines  $k: \mathcal{X}(V, TM) \rightarrow \mathcal{X}^L(M, TM)$ .

The final sentence of the proof holds provided that we choose the tubular neighborhoods small enough to have fibers contained in  $S$  at points in  $V \cap \partial M$ , or in  $\partial M - S$  at points in  $V \cap (\partial M - S)$ .  $\square$

LEMMA 3.1.7 (Exponentiation Lemma). *Assume that the metric on  $M$  is a product near the boundary, and let  $K$  be a compact subset of  $M$ . Then there exists a neighborhood  $U$  of  $Z$  in  $\mathcal{X}^K(M, TM)$  such that  $\text{TExp}(X)$  is defined for all  $X \in U$ , and  $\text{TExp}$  carries  $U$  into  $\text{Diff}^K M$ .*

PROOF. Form a manifold  $N$  from  $M$  and  $\partial M \times (-\infty, 0]$  by identifying  $\partial M$  with  $\partial M \times \{0\}$ , and extending the metric on  $M$  using the product of the complete metric on  $\partial M$  and the standard metric on  $(-\infty, 0]$ . By Lemma 2.3.2, there is a continuous linear extension  $E: \mathcal{Y}(M, TM) \rightarrow \mathcal{Y}(N, TN)$  for which the image is contained in the subspace of sections that vanish on  $\partial M \times (-\infty, -1]$ . Put  $L = K \cup (K \cap \partial M) \times [-1, 0]$ . As seen in the proof of Lemma 2.3.2, the extended vector fields may be chosen to lie in  $\mathcal{Y}^L(N, TN)$ . Since  $N$  is complete and open, there is a neighborhood  $W$  of  $Z$  in  $\mathcal{Y}^L(N, TN)$  for which  $\text{Exp}(E(Y(x)))$  is defined for all  $Y \in W$  and  $x \in N$ . That is,  $\text{TExp}: W \rightarrow C^\infty(N, N)$  is defined.

Since  $\text{Diff}(N)$  is an open subset of  $C^\infty(N, N)$ ,  $W$  may be chosen smaller, if necessary, to ensure that it is carried into  $\text{Diff}(N)$  by  $\text{TExp}$ . Diffeomorphisms obtained from extended vector fields of  $\mathcal{X}(M, TM)$  carry  $\partial M$  to  $\partial M$ , so  $\text{TExp}$  carries the neighborhood  $U = \mathcal{X}^K(M, TM) \cap E^{-1}(W)$  of  $Z$  in  $\mathcal{X}^K(M, TM)$  into  $\text{Diff}^K(M)$ .  $\square$

We are now set up for the main results of this section. At this point the reader may wish to review Definitions 3.0.5 and 3.0.6.

THEOREM 3.1.8. *Let  $V$  be a compact submanifold of  $M$ , and let  $S$  be a closed neighborhood in  $\partial M$  of  $S \cap \partial V$ . Let  $L$  be a compact*

neighborhood of  $V$  in  $M$ . Then  $\text{Emb}^L(V, M \text{ rel } S \cap \partial V)$  admits local  $\text{Diff}^L(M \text{ rel } S)$  cross-sections.

PROOF. By Proposition 3.1.4 it suffices to find a local cross-section at the inclusion map  $i_V$ . Using Lemmas 3.1.5 and 3.1.6, we obtain an open neighborhood  $W$  of  $i_V$  in  $\text{Emb}(V, M \text{ rel } S \cap \partial V)$  and continuous maps  $X: W \rightarrow \mathcal{X}(V, TM)$  and  $k: \mathcal{X}(V, TM) \rightarrow \mathcal{X}^L(M, TM)$ . By Lemma 3.1.7, there is a neighborhood  $U$  of  $Z$  in  $\mathcal{X}^L(M, TM)$  for which the map  $F: U \rightarrow \text{Diff}^L(M)$  sending  $Y$  to  $\text{TExp}(Y)$  is defined and continuous. Choosing a neighborhood  $U_1$  of  $i_V$  contained in  $W \cap (k \circ X)^{-1}(U)$ , the function  $F \circ k \circ X: U_1 \rightarrow \text{Diff}^L(M \text{ rel } S)$  will be the desired cross-section.

To see that the image of this function lies in  $\text{Diff}^L(M \text{ rel } S)$ , suppose that  $j(x) = x$  for all  $x \in V \cap S$ . Then  $X(j)(x) = Z(x)$  for  $x \in V \cap S$ . By the condition in Lemma 3.1.6,  $k(X(j))(x) = Z(x)$  and consequently  $(FkX(j))(x) = x$  for all  $x \in S$ .  $\square$

Using Proposition 3.1.2 we obtain immediate corollaries of Theorem 3.1.8:

**COROLLARY 3.1.9.** *Let  $V$  be a compact submanifold of  $M$ . Let  $S \subseteq \partial M$  be a closed neighborhood in  $\partial M$  of  $S \cap \partial V$ , and  $L$  a neighborhood of  $V$  in  $M$ . Then the restriction  $\text{Diff}^L(M \text{ rel } S) \rightarrow \text{Emb}^L(V, M \text{ rel } S)$  is locally trivial.*

**COROLLARY 3.1.10.** *Let  $V$  and  $W$  be compact submanifolds of  $M$ , with  $W \subseteq V$ . Let  $S \subseteq \partial M$  a closed neighborhood in  $\partial M$  of  $S \cap \partial V$ , and  $L$  a neighborhood of  $V$  in  $M$ . Then the restriction  $\text{Emb}^L(V, M \text{ rel } S) \rightarrow \text{Emb}^L(W, M \text{ rel } S)$  is locally trivial.*

### 3.2. The space of images

As an initial application of these methods, we examine the space of images. This is well-known material (see for example Section 44 of [41]), although it seems to be rarely examined in the bounded case. In the next definition,  $\text{Diff}(M, V)$  denotes the subgroup of  $\text{Diff}(M)$  consisting of the diffeomorphisms that take the submanifold  $V$  onto  $V$ .

**DEFINITION 3.2.1.** Let  $V$  be a submanifold of  $M$  as in Definition 2.4.1. The space  $\text{Img}(V, M)$  of *images* of  $V$  in  $M$  is the space of orbits  $\text{Diff}(M)/\text{Diff}(M, V)$ .

For  $j, k \in \text{Diff}(M)$ ,  $j = k$  in  $\text{Img}(V, M)$  if and only if  $j(V) = k(V)$ . Consequently, we may write elements of  $\text{Img}(V, M)$  as  $j(V)$  with  $j \in \text{Diff}(M, V)$ .

The next result is basically Theorem 44.1 of [41].

**THEOREM 3.2.2.** *Let  $V$  be a submanifold of a compact manifold  $M$ .*

- (i) *If  $V$  has positive codimension, then  $\text{Img}(V, M)$  is a Fréchet manifold, locally modeled on the Fréchet space of sections from  $V$  to its normal bundle in  $M$ . Moreover,  $\text{Diff}(M)$  is the total space of a locally trivial principal bundle with structure group  $\text{Diff}(M, V)$ , whose base space is  $\text{Img}(V, M)$ .*
- (ii) *If  $V$  has codimension zero, and  $W$  is the frontier of  $V$  in  $M$ , then the restriction map  $\text{Img}(V, M) \rightarrow \text{Img}(W, M)$  is either a two-sheeted covering map or a homeomorphism, according to whether or not there exists a diffeomorphism of  $M$  that preserves  $W$  and interchanges  $V$  and  $\overline{M - V}$ .*

**PROOF.** Assume first that  $V$  has positive codimension. The map  $\text{Emb}(V, M) \rightarrow \text{Img}(V, M)$  is  $\text{Diff}(M)$ -equivariant, so to prove that  $\text{Emb}(V, M) \rightarrow \text{Img}(V, M)$  is locally trivial, it suffices to find local  $\text{Diff}(M)$  cross-sections at points in  $\text{Img}(V, M)$ . Since  $\text{Diff}(M)$  acts transitively on  $\text{Img}(V, M)$ , it suffices to find a local cross-section at  $1_M \text{Diff}(M, V)$ .

Let  $\nu(V)$  be the normal bundle of  $V$ . For some  $\epsilon$ ,  $\text{Exp}: \nu_\epsilon(V) \rightarrow M$  is a tubular neighborhood of  $V$ , where  $\nu_\epsilon(V)$  is the space of vectors of length less than  $\epsilon$ . For each  $g \in \text{Diff}(M, V)$  in some neighborhood  $U$  of  $1_M \text{Diff}(M, V)$ ,  $g(V)$  meets each fiber of the tubular neighborhood in a single point. So at each  $x \in V$ , there is a unique normal vector  $X(g)(x)$  in the fiber  $\nu_x(V)$  of the normal bundle of  $V$  at  $x$  such that  $\text{Exp}(X(g)(x)) = g(V) \cap \text{Exp}(\nu_x(V))$ . This defines  $X: U \rightarrow \mathcal{X}(V, TM)$ . Note that  $X^{-1}$  defines a local chart for the Fréchet structure of  $\text{Img}(V, M)$  at  $i$ , showing that  $\text{Emb}(V, M)$  is a Fréchet manifold.

By the Extension Lemma 3.1.6, there is a continuous linear map  $k: \mathcal{X}(V, TM) \rightarrow \mathcal{X}(M, TM)$  such that  $k(Y)(x) = Y(x)$  for all  $x$  in  $V$  and all  $Y$  in  $\mathcal{X}(V, TM)$ . By the Exponentiation Lemma 3.1.7, there is a neighborhood  $K$  of  $Z$  in  $\mathcal{X}(M, TM)$  such that  $\text{TExp}(Y)$  is defined for all  $Y \in K$ , and  $\text{TExp}$  carries  $K$  into  $\text{Diff}(M)$ . Provided that our original  $U$  was selected small enough that  $k(X(U)) \subset K$ , the composition  $\text{TExp} \circ k \circ X: U \rightarrow \text{Diff}(M)$  is the desired local cross-section.

Suppose now that  $V$  has codimension zero, with frontier  $W$ . If there does not exist an element of  $\text{Diff}(M, W)$  that interchanges  $V$  and  $\overline{M - V}$ , then  $\text{Diff}(M, W) = \text{Diff}(M, V)$ , and the restriction map sending  $j \in \text{Diff}(M, V)$  to  $j|_W \in \text{Diff}(M, W)$  defines a homeomorphism between  $\text{Img}(V, M)$  and  $\text{Img}(W, M)$ . In the remaining case, we fix an element  $H_0 \in \text{Diff}(M, W)$  that interchanges  $V$  and  $\overline{M - V}$ .

Define  $\rho: \text{Img}(V, M) \rightarrow \text{Img}(W, M)$  by sending  $j \in \text{Diff}(M, V)$  to  $j|_W \in \text{Diff}(M, W)$ , i. e. sending  $j(V)$  to  $j(W)$ . This is well-defined, since if  $j_1(V) = j_2(V)$  then  $j_1(W) = j_2(W)$ .

A free involution  $\tau$  on  $\text{Img}(V, M)$  is defined by sending  $j(V)$  to  $j(H_0(V))$ . To see that  $\text{Img}(W, M)$  is the quotient of  $\text{Img}(V, M)$  by this involution, let  $j_1(V), j_2(V) \in \text{Img}(V, M)$  and suppose that  $j_1(W) = j_2(W)$ . Then either  $j_1(V) = j_2(V)$  or  $j_1(V) = j_2(\overline{M - V})$ . The latter case says exactly that  $j_1(V) = j_2(H_0(V))$ .  $\square$

### 3.3. Projection of fiber-preserving diffeomorphisms

Throughout this section and the next, it is understood that  $p: E \rightarrow B$  is a locally trivial smooth map as in Section 2.6, such that the metric on  $B$  is a product near  $\partial B$ , and the metric on  $E$  is a product near  $\partial_h E$  such that the I-fibers of  $\partial_h E \times I$  are vertical. When  $W$  is a vertical submanifold of  $E$ , it is then automatic that  $W$  meets the collar  $\partial_h E \times I$  in I-fibers. By rechoosing the metric on  $B$ , we may assume that  $p(W)$  meets the collar  $\partial B \times I$  in I-fibers. From Definition 2.5.2, we have the notations  $\partial_h W = W \cap \partial_h E$  and  $\partial_v W = W \cap \partial_v E$ .

We now examine the fundamental lemmas of [51] in the fiber-preserving case. Lemma 3.1.5 adapts straightforwardly using the aligned exponential from Definition 2.6.2 and the aligned vector fields from Definition 2.6.1.

**LEMMA 3.3.1** (Logarithm Lemma for fiber-preserving maps). *Assume that  $p: E \rightarrow B$  has compact fiber, and suppose that  $W$  is a compact vertical submanifold of  $E$ . Then there are an open neighborhood  $U$  of the inclusion  $i_W$  in  $\text{Emb}_f(W, E)$  and a continuous map  $X: U \rightarrow \mathcal{A}(W, TE)$  such that for all  $j \in U$ ,  $\text{Exp}_a((X(j))(x))$  is defined for all  $x \in W$  and  $\text{Exp}_a((X(j))(x)) = j(x)$  for all  $x \in W$ . Moreover,  $X(i_W) = Z$ .*

**PROOF.** We adapt the argument in Lemma 3.1.5, using the aligned exponential. Choose  $\epsilon$  small enough so that for all  $x \in W$ ,  $\text{Exp}$  carries the  $\epsilon$ -ball about 0 in  $T_x(E)$  (that is, the portion of this  $\epsilon$ -ball on which it is defined, which may be as small as a closed quarter-ball when  $x \in \partial_v E \cap \partial_h E$ ) diffeomorphically to a neighborhood  $W_x$  of  $x$  in  $E$ . Choose a neighborhood  $U$  of  $i_W$  in  $\text{Emb}_f(W, E)$  so that if  $j \in U$  then  $j(x) \in W_x$ . For  $j \in U$  define  $X(j)(x)$  to be the unique vector in  $T_x(M)$  of length less than  $\epsilon$  for which  $\text{Exp}_a(X(j)(x))$  equals  $j(x)$ . Since  $p \circ j(x) = p \circ j(y)$  whenever  $p(x) = p(y)$ , and  $j$  is close to the inclusion,  $X \in \mathcal{A}(W, TE)$ .  $\square$

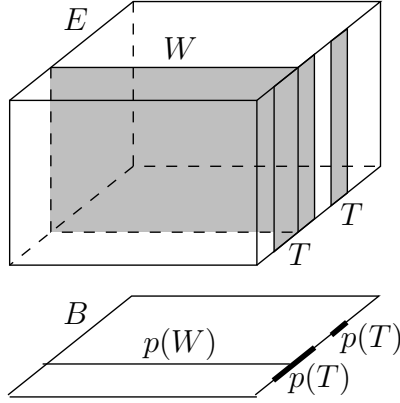
 FIGURE 3.1. The neighborhood  $T$  in Lemma 2.6.1.

LEMMA 3.3.2 (Extension Lemma for fiber-preserving maps). *Let  $W$  be a compact vertical submanifold of  $E$ . Let  $T$  be a closed fibered neighborhood in  $\partial_v E$  of  $T \cap \partial_v W$ , and let  $L \subseteq E$  be a neighborhood of  $W$ . Then there is a continuous linear map  $k: \mathcal{A}(W, TE) \rightarrow \mathcal{A}^L(E, TE)$  such that  $k(X)(x) = X(x)$  for all  $x \in W$  and all  $X \in \mathcal{A}(W, TE)$ . If  $X(x) = Z(x)$  for all  $x \in T \cap \partial_v W$ , then  $k(X)(x) = Z(x)$  for all  $x \in T$ . Furthermore,  $k(\mathcal{V}(W, TE)) \subset \mathcal{V}^L(E, TE)$ .*

Figure 3.1 illustrates the neighborhood  $T$  in Lemma 3.3.2.

PROOF OF LEMMA 3.3.2. For an aligned vector field  $X$ , we use Lemma 3.1.6 followed by projection to the vertical components to extend the vertical part. When  $X = Z$  on  $T \cap \partial_v W$ , the extension and hence its vertical projection are  $Z$  on  $T$ . For the horizontal part, project to  $B$ , extend using Lemma 3.1.6, and take horizontal lifts. The extensions in  $B$  are selected to vanish outside a neighborhood  $L'$  whose inverse image lies in  $L$ . In addition, taking  $S = p(T)$  in Lemma 3.1.6, the extension in  $B$  is  $Z$  on  $p(T)$  when  $X = Z$  on  $T \cap \partial_v(W)$ , ensuring that the lift is  $Z$  on  $T$  in this case.  $\square$

LEMMA 3.3.3 (Exponentiation Lemma for fiber-preserving maps). *Let  $p: E \rightarrow B$  be a fiber bundle with compact fiber, and assume that the metric on  $E$  is a product near  $\partial_h(E)$ . Let  $K$  be a compact subset of  $E$ . Then there exists a neighborhood  $U$  of  $Z$  in  $\mathcal{A}^K(E, TE)$  such that  $\text{TExp}_a(X(x))$  is defined for all  $X \in U$  and  $\text{TExp}_a$  carries  $U$  into  $\text{Diff}_f^K(E)$ .*

PROOF. As in the proof of Lemma 3.1.7, enlarge  $E$  to a complete open manifold  $N$  by attaching  $\partial_h E \times [0, \infty)$  along  $\partial_h E$ . For each fiber  $F$  in  $E$ , put  $\partial_h F = F \cap \partial_h E$ . Then  $N$  is still a fiber bundle over  $B$ ,

where each fiber  $F$  has been enlarged to an open manifold by attaching  $\partial_h F \times [0, \infty)$  along  $F \cap \partial_h E$ . We denote this fibering by  $p_N: N \rightarrow B$ .

Now, consider a vector field  $X \in \mathcal{A}^K(E, TE)$ . We extend the vertical and horizontal parts  $X_v$  and  $X_h$  to  $N$  separately. For  $X_v$ , we extend using Lemma 2.3.2, then project into the vertical subspace at each point. For  $X_h$ , at each point  $x \in N - E$ , we just take the horizontal lift of  $p_*(X(y))$  for some  $y \in E$  with  $p(y) = p_N(x)$ , so that the extended vector field is aligned. Its restriction to  $E \cup \partial_h E \times [0, 1]$  is tangent to  $\partial_h E$ . The vertical part of the extension, constructed using Lemma 2.3.2, vanishes off of  $K \cup (K \cap \partial_h E) \times [0, 1]$ . The proof is now completed as in Lemma 3.1.7, using the aligned exponential on  $E \cup \partial_h E \times [0, 1]$ , and taking  $L = K \cup (K \cap \partial_h E) \times [0, 1]$ .  $\square$

**DEFINITION 3.3.4.** Let  $p: E \rightarrow B$  be a fiber bundle. For an element  $g$  of  $\text{Diff}_f(E)$ , the induced diffeomorphism of  $B$  will be denoted by  $\bar{g}$ . More generally, if  $W$  is a vertical submanifold of  $E$ , each  $j \in \text{Emb}_f(W, E)$  induces an embedding of  $p(W)$  into  $B$ , denoted by  $\bar{j}$ . Note that  $\text{Diff}_f(E)$  acts on  $\text{Diff}(B)$  and on  $\text{Emb}(p(W), B)$  by sending  $h$  to  $\bar{g}h$ . More generally, if  $S \subset \partial B$  is a neighborhood of  $S \cap \partial p(W)$  and  $K$  is a neighborhood of  $W$ , then  $\text{Diff}_f^{p^{-1}(K)}(E \text{ rel } p^{-1}(S))$  acts in this way on  $\text{Diff}^K(B \text{ rel } S)$  and  $\text{Emb}^K(W, B \text{ rel } S)$ .

**THEOREM 3.3.5.** Let  $K$  be a compact subset of  $B$ , let  $S$  be a subset of  $\partial B$ , and put  $T = p^{-1}(S)$ . Then  $\text{Diff}^K(B \text{ rel } S)$  admits local  $\text{Diff}_f^{p^{-1}(K)}(E \text{ rel } T)$  cross-sections.

**PROOF.** By Proposition 3.1.4, it suffices to find a local cross-section at the identity  $id_B$ . Let  $L$  be a compact codimension-zero submanifold of  $B$  that contains  $K$  in its topological interior (and such that as usual,  $L$  meets  $\partial B \times I$  in  $I$ -fibers). By Lemma 3.1.5, there are a neighborhood  $U$  of the inclusion  $i_L$  in  $\text{Emb}(L, B)$  and a continuous map  $X: U \rightarrow \mathcal{X}(L, TB)$  such that for all  $j \in U$  and all  $x \in L$ ,  $\text{Exp}(X(j)(x))$  is defined and  $\text{Exp}(X(j)(x)) = j(x)$ .

Suppose that  $f \in \text{Diff}^K(B \text{ rel } S)$ . Then  $X(f|_L)$  vanishes on a neighborhood in  $L$  of the frontier of  $L$  in  $B$ , and on  $L \cap S$ , so the vector field  $X(f|_L)$  extends to a smooth vector field  $X'(f|_L)$  on  $B$  using  $Z$  on  $B - K$ , which vanishes on  $S$ . For each  $x \in B$ ,  $\text{Exp}(X'(j)(x))$  is defined and  $\text{Exp}(X'(j)(x)) = f(x)$ . At each point  $y$  of  $E$ , let  $\widetilde{X}'(j)(y)$  be the horizontal lift of  $X'(j)(p(y))$ . This produces an aligned vector field in  $\mathcal{A}^{p^{-1}(L)}(E, TE)$ , which vanishes on  $T$ .

Choose a neighborhood  $V$  of  $id_B$  in  $\text{Diff}^K(B \text{ rel } S)$  such that  $f|_L \in U$  for each  $f \in V$ . On  $V$ , define  $\chi(f) = \text{TExp}_a(\widetilde{X}'(f|_L))$ .

Since  $\widetilde{X}'(f|_L)$  vanishes on  $T$  and off of  $p^{-1}(K)$ , this defines  $\chi: V \rightarrow \text{Diff}_f^{p^{-1}(K)}(E \text{ rel } T)$ . This is a local cross-section, since given  $b \in K \subseteq L$  we may choose any  $y$  with  $p(y) = b$  and calculate that for the induced diffeomorphism  $\overline{\chi(f)}$  on  $B$ ,

$$\begin{aligned} \overline{\chi(f)}(b) &= p(\chi(f)(x)) \\ &= p(\text{Exp}_a(\widetilde{X}(\rho(f))(x))) \\ &= \text{Exp}(X(\rho(f))(b)) \\ &= f(b) \end{aligned}$$

while at points in  $B - K$ ,  $\overline{\chi(f)}(b) = b$ . □

From Proposition 3.1.2, we have immediately

**THEOREM 3.3.6.** *Let  $K$  be a compact subset of  $B$ . Let  $S \subseteq \partial B$  and let  $T = p^{-1}(S)$ . Then  $\text{Diff}_f^{p^{-1}(K)}(E \text{ rel } T) \rightarrow \text{Diff}^K(B \text{ rel } S)$  is locally trivial.*

Each of the fibration theorems we prove has a corresponding corollary involving parameterized lifting or extension, but since the statements are all analogous we give only the following one as a prototype.

**COROLLARY 3.3.7. (Parameterized Isotopy Lifting Theorem)** *Let  $K$  be a compact subset of  $B$ , let  $S \subseteq \partial B$ , and let  $T = p^{-1}(S)$ . Suppose that for each  $t$  in a path-connected parameter space  $P$  there is an isotopy  $g_{t,s}$ , such that each  $g_{t,s}$  is the identity on  $S$  and outside of  $K$ , and such that  $g_{t,0}$  lifts to a diffeomorphism  $G_{t,0}$  of  $E$  which is the identity on  $T$ . Assume that sending  $(t, s) \rightarrow g_{t,s}$  defines a continuous function from  $P \times [0, 1]$  to  $\text{Diff}(B \text{ rel } S)$  and sending  $t$  to  $G_{t,0}$  defines a continuous function from  $P$  to  $\text{Diff}(E \text{ rel } T)$ . Then the family  $G_{t,0}$  extends to a continuous family on  $P \times I$  such that for each  $(t, s)$ ,  $G_{t,s}$  is a fiber-preserving diffeomorphism inducing  $g_{t,s}$  on  $B$ .*

### 3.4. Restriction of fiber-preserving diffeomorphisms

In this section we present the analogues of the main results of Palais [51] in the fibered case. As usual, we tacitly assume that metrics are products near the boundary and that submanifolds meet the boundary in I-fibers. We remind the reader about Figure 3.1, which indicates the setup in the next result.

**THEOREM 3.4.1.** *Let  $W$  be a compact vertical submanifold of  $E$ . Let  $T$  be a closed fibered neighborhood in  $\partial_v E$  of  $T \cap \partial_v W$ , and let  $L$  be a neighborhood of  $W$ . Then*

- (i)  $\text{Emb}_f^L(W, E \text{ rel } T)$  admits local  $\text{Diff}_f^L(E \text{ rel } T)$  cross-sections,  
and
- (ii)  $\text{Emb}_v(W, E \text{ rel } T)$  admits local  $\text{Diff}_v^L(E \text{ rel } T)$  cross-sections.

PROOF. By Proposition 3.1.4, it suffices to find local cross-sections at the inclusion  $i_W$ . Choose a compact neighborhood  $K$  of  $W$  with  $K \subseteq L$  and  $K = p^{-1}(p(K))$ .

By Lemma 3.3.1, there are a neighborhood  $U_1$  of the inclusion  $i_W$  in  $\text{Emb}_f(W, E)$  and a continuous map  $X: U_1 \rightarrow \mathcal{A}(W, TE)$  such that for all  $j \in U_1$  and all  $x \in W$ ,  $\text{Exp}_a(X(j)(x))$  is defined and  $\text{Exp}_a(X(j)(x)) = j(x)$ . By Lemma 3.3.2, there is a continuous linear map  $k: \mathcal{A}(W, TE) \rightarrow \mathcal{A}^K(E, TE)$ , with  $k(\mathcal{V}(W, TE)) \subset \mathcal{V}^K(E, TE)$ , such that  $k(X)(x) = X(x)$  for all  $x \in W$ . Lemma 3.3.3 now gives a neighborhood  $U_2$  of  $Z$  in  $\mathcal{A}^K(E, TE)$  such that  $\text{Exp}_a(X)$  is defined for all  $X \in U_2$ , and  $\text{TExp}_a$  has image in  $\text{Diff}_f^K(E)$ . Putting  $U = X^{-1}(k^{-1}(U_2))$ , the composition  $\text{TExp}_a \circ k \circ X: U \rightarrow \text{Diff}_f^K(E)$  is the desired cross-section for (i).

Since  $X$  carries  $\text{Emb}_v(W, B)$  into  $\mathcal{V}(W, TE)$ ,  $k$  carries  $\mathcal{V}(W, TE)$  into  $\mathcal{V}^K(E, TE)$ , and  $\text{TExp}_a$  carries  $U_2 \cap \mathcal{V}^K(E, TE)$  into  $\text{Diff}_v(E)$ , this cross-section restricts on  $\text{Emb}_v(W, E \text{ rel } T)$  to a  $\text{Diff}_v^L(E \text{ rel } T)$  cross-section, giving (ii).  $\square$

Proposition 3.1.2 has the following immediate corollaries.

COROLLARY 3.4.2. *Let  $W$  be a compact vertical submanifold of  $E$ . Let  $T$  be a closed fibered neighborhood in  $\partial_v E$  of  $T \cap \partial_v W$ , and  $L$  a neighborhood of  $W$ . Then the following restrictions are locally trivial:*

- (i)  $\text{Diff}_f^L(E \text{ rel } T) \rightarrow \text{Emb}_f^L(W, E \text{ rel } T)$ , and
- (ii)  $\text{Diff}_v^L(E \text{ rel } T) \rightarrow \text{Emb}_v(W, E \text{ rel } T)$ .

COROLLARY 3.4.3. *Let  $V$  and  $W$  be vertical submanifolds of  $E$ , with  $W \subseteq V$ . Let  $T$  be a closed fibered neighborhood in  $\partial_v E$  of  $T \cap \partial_v V$ , and let  $L$  a neighborhood of  $V$ . Then the following restrictions are locally trivial:*

- (i)  $\text{Emb}_f^L(V, E \text{ rel } T) \rightarrow \text{Emb}_f^L(W, E \text{ rel } T)$ .
- (ii)  $\text{Emb}_v(V, E \text{ rel } T) \rightarrow \text{Emb}_v(W, E \text{ rel } T)$ .



The final result of this section is the projection-restriction square for bundles.

**THEOREM 3.4.4.** *Let  $W$  be a compact vertical submanifold of  $E$ . Let  $K$  be a compact neighborhood of  $p(W)$  in  $B$ . Let  $T$  be a closed fibered neighborhood in  $\partial_v E$  of  $T \cap \partial_v W$ , and put  $S = p(T)$ . Then all four maps in the following commutative square are locally trivial:*

$$\begin{array}{ccc} \mathrm{Diff}_f^{p^{-1}(K)}(E \text{ rel } T) & \longrightarrow & \mathrm{Emb}_f^{p^{-1}(K)}(W, E \text{ rel } T) \\ \downarrow & & \downarrow \\ \mathrm{Diff}^K(B \text{ rel } S) & \longrightarrow & \mathrm{Emb}^K(p(W), B \text{ rel } S) . \end{array}$$

**PROOF.** The top arrow is Corollary 3.4.2(i), the left vertical arrow is Theorem 3.3.5, and the bottom arrow is Corollary 3.1.9. For the right vertical arrow, we will first show that  $\mathrm{Emb}^K(p(W), B \text{ rel } S)$  admits local  $\mathrm{Diff}_f^{p^{-1}(K)}(E \text{ rel } T)$  cross-sections. Let  $i \in \mathrm{Emb}^K(p(W), B \text{ rel } S)$ . Using Theorems 3.4.1 and 3.3.5, choose local cross-sections  $\chi_1: U \rightarrow \mathrm{Diff}^K(B \text{ rel } S)$  at  $i$  and  $\chi_2: V \rightarrow \mathrm{Diff}_f^{p^{-1}(K)}(E \text{ rel } T)$  at  $\chi_1(i)$ . Let  $U_1 = \chi_1^{-1}(V)$ , then for  $j \in U_1$  we have

$$\overline{\chi_2 \chi_1(j)} i = \overline{\chi_2(\chi_1(j))} i = \chi_1(j) i = j .$$

Since the right vertical arrow is  $\mathrm{Diff}_f^{p^{-1}(K)}(E \text{ rel } T)$ -equivariant, Proposition 3.1.2 implies that it is locally trivial.  $\square$

### 3.5. Restriction theorems for orbifolds

Throughout this section, indeed in all of our work, an orbifold means an orbifold in the standard sense whose universal covering  $\pi: \tilde{\mathcal{O}} \rightarrow \mathcal{O}$  is a manifold. We assume further that  $\mathcal{O}$  is a smooth orbifold, meaning that  $\tilde{\mathcal{O}}$  is a smooth manifold and the group  $H$  of covering transformations consists of diffeomorphisms.

**DEFINITION 3.5.1.** A map  $f: \tilde{\mathcal{O}} \rightarrow \tilde{\mathcal{O}}$  is called (*weakly*)  $H$ -equivariant if for some automorphism  $\alpha$  of  $H$ ,  $f(h(x)) = \alpha(h)(f(x))$  for all  $x \in \tilde{\mathcal{O}}$  and  $h \in H$ . Define  $C_H^\infty(\tilde{\mathcal{O}})$  to be the space of  $H$ -equivariant boundary-preserving smooth maps from  $\tilde{\mathcal{O}}$  to  $\tilde{\mathcal{O}}$ , and  $\mathrm{Diff}_H(\tilde{\mathcal{O}})$  to be the  $H$ -equivariant diffeomorphisms of  $\tilde{\mathcal{O}}$ . Note that  $\mathrm{Diff}_H(\tilde{\mathcal{O}})$  is the normalizer of  $H$  in  $\mathrm{Diff}(\tilde{\mathcal{O}})$ .

**DEFINITION 3.5.2.** An *orbifold homeomorphism* of  $\mathcal{O}$  is a homeomorphism of the underlying topological space of  $\mathcal{O}$  that is induced by an  $H$ -equivariant homeomorphism of  $\tilde{\mathcal{O}}$ , called a *lift* of the orbifold

homeomorphism. An orbifold diffeomorphism of  $\mathcal{O}$  is an orbifold homeomorphism for which some and hence all lifts to  $\tilde{\mathcal{O}}$  are diffeomorphisms. Define  $\text{Diff}(\mathcal{O})$  to be the group of orbifold diffeomorphisms. Note that  $\text{Diff}(\mathcal{O})$  is the quotient of  $\text{Diff}_H(\tilde{\mathcal{O}})$  by the normal subgroup  $H$ . We give  $\text{Diff}(\mathcal{O})$  the quotient topology of the  $C^\infty$ -topology on  $\text{Diff}_H(\tilde{\mathcal{O}})$ .

DEFINITION 3.5.3. An orbifold  $\mathcal{W}$  contained in  $\mathcal{O}$  is called a *suborbifold* of  $\mathcal{O}$  if its inverse image  $\tilde{\mathcal{W}}$  in  $\tilde{\mathcal{O}}$  is a submanifold. An element of  $\text{Emb}(\tilde{\mathcal{W}}, \tilde{\mathcal{O}})$  is called *H-equivariant* if it extends to an element of  $\text{Diff}_H(\tilde{\mathcal{O}})$ , and the subspace of *H-equivariant* embeddings is denoted by  $\text{Emb}_H(\tilde{\mathcal{W}}, \tilde{\mathcal{O}})$ . An *embedding* of  $\mathcal{W}$  into  $\mathcal{O}$  is an embedding induced by an element of  $\text{Emb}_H(\tilde{\mathcal{W}}, \tilde{\mathcal{O}})$ , and the space of embeddings is denoted by  $\text{Emb}(\mathcal{W}, \mathcal{O})$ .

Throughout this section,  $\mathcal{W}$  will denote a compact suborbifold of  $\mathcal{O}$ .

DEFINITION 3.5.4. A section from an *H-equivariant* subset  $\tilde{L}$  of  $\tilde{\mathcal{O}}$  to  $T\tilde{\mathcal{O}}|_{\tilde{L}}$  is called *H-equivariant* if for each  $x \in \tilde{L}$  and each  $h \in H$ ,  $h_*(X(x)) = X(h(x))$ . In general, we use a subscript *H* to indicate the *H-equivariant* elements of any of the spaces of sections that we have defined, thus for example  $\mathcal{X}_H(\tilde{\mathcal{W}}, T\tilde{\mathcal{O}})$  means the *H-equivariant* elements of  $\mathcal{X}(\tilde{\mathcal{W}}, T\tilde{\mathcal{O}})$ .

The next two lemmas provide equivariant functions and metrics.

LEMMA 3.5.5. *Let  $H$  be a group acting smoothly and properly discontinuously on a manifold  $M$ , possibly with boundary, such that  $M/H$  is compact. Let  $A$  be an  $H$ -invariant closed subset of  $M$ , and  $U$  an  $H$ -invariant neighborhood of  $A$ . Then there exists an  $H$ -equivariant smooth function  $\gamma: M \rightarrow [0, 1]$  that is identically equal to 1 on  $A$  and whose support is contained in  $U$ .*

PROOF. Fix a compact subset  $C$  of  $M$  which maps surjectively onto  $M/H$  under the quotient map. Let  $\phi: M \rightarrow [0, \infty)$  be a smooth function such that  $\phi(x) \geq 1$  for all  $x \in C \cap A$  and whose support is compact and contained in  $U$ . Define  $\psi$  by  $\psi(x) = \sum_{h \in H} \phi(h(x))$ . Now choose  $\eta: \mathbb{R} \rightarrow [0, 1]$  such that  $\eta(r) = 0$  for  $r \leq 0$  and  $\eta(r) = 1$  for  $r \geq 1$ , and put  $\gamma = \eta \circ \psi$ .  $\square$

When  $\mathcal{O}$  is compact, the following lemma provides a Riemannian metric on  $\tilde{\mathcal{O}}$  for which the covering transformations are isometries.

LEMMA 3.5.6. *Let  $H$  be a group acting smoothly and properly discontinuously on a manifold  $M$ , possibly with boundary, such that  $M/H$  is compact. Let  $N$  be a properly embedded  $H$ -invariant submanifold,*

possibly empty. Then  $M$  admits a complete  $H$ -equivariant Riemannian metric, which is a product near  $\partial M$ , and such that  $N$  meets  $\partial M \times I$  in  $I$ -fibers. Moreover, the action preserves the collar, and if  $(y, t) \in \partial M \times I$  and  $h \in H$ , then  $h(y, t) = (h|_{\partial M}(y), t)$ .

PROOF. We first prove that equivariant Riemannian metrics exist. Choose a compact subset  $C$  of  $M$  that maps surjectively onto  $M/H$  under the quotient map. Let  $\phi: M \rightarrow [0, \infty)$  be a compactly supported smooth function which is positive on  $C$ . Choose a Riemannian metric  $R$  on  $M$  and denote by  $R_x$  the inner product which  $R$  assigns to  $T_x(M)$ . Define a new metric  $R'$  by

$$R'_x(v, w) = \sum_{h \in H} \phi(h(x)) R_{h(x)}(h_*(v), h_*(w)) .$$

Since  $\phi$  is compactly supported, the sum is finite, and since every orbit meets the support of  $\phi$ ,  $R'$  is positive definite. To check equivariance, let  $g \in H$ . Then

$$\begin{aligned} R'_{g(x)}(g_*(v), g_*(w)) &= \sum_{h \in H} \phi(h(g(x))) R_{h(g(x))}(h_*(g_*(v)), h_*(g_*(w))) \\ &= \sum_{h \in H} \phi(hg(x)) R_{hg(x)}((hg)_*(v), (hg)_*(w)) \\ &= R'_x(v, w) . \end{aligned}$$

We need to improve the metric near the boundary. First, note that  $C \cap \partial M$  maps surjectively onto the image of  $\partial M$ . Choose an inward-pointing vector field  $\tau'$  on a neighborhood  $U$  of  $C \cap \partial M$ , which is tangent to  $N$ . Choose a smooth function  $\phi: M \rightarrow [0, \infty)$  which is positive on  $C \cap \partial M$  and has compact support contained in  $U$ . The field  $\phi\tau'$  defined on  $U$  extends using the zero vector field on  $M - U$  to a vector field  $\tau$  which is nonvanishing on  $C \cap \partial M$ . For  $x$  in the union of the  $H$ -translates of  $U$ , define  $\omega_x = \sum_{h \in H} \phi(h(x)) h_*^{-1}(\tau_{h(x)})$ . This is defined, nonsingular, and equivariant on an  $H$ -invariant neighborhood of  $\partial M$ , and we use it to define a collar  $\partial M \times [0, 2]$  equivariant in the sense that if  $(y, t) \in \partial M \times [0, 2]$  then  $h(y, t) = (h|_{\partial M}(y), t)$ . Moreover,  $N$  meets this collar in  $I$ -fibers. On  $\partial M \times [0, 2]$ , choose an equivariant metric  $R_1$  which is the product of an equivariant metric on  $\partial M$  and the standard metric on  $[0, 2]$ , and choose any equivariant metric  $R_2$  defined on all of  $M$ . Using Lemma 3.5.5, choose  $H$ -equivariant functions  $\phi_1$  and  $\phi_2$  from  $M$  to  $[0, 1]$  so that  $\phi_1(x) = 1$  for all  $x \in \partial M \times [0, 3/2]$  and the support of  $\phi_1$  is contained in  $\partial M \times [0, 2)$ , and so that  $\phi_2(x) = 1$  for  $x \in M - \partial M \times [0, 3/2]$  and the support of  $\phi_2$  is contained in  $M - \partial M \times [0, 1]$ . Then,  $\phi_1 R_1 + \phi_2 R_2$  is  $H$ -equivariant and is a product near  $\partial M$ , and  $N$  is vertical in  $\partial M \times I$ .

Since  $M/H$  is compact and  $H$  acts as isometries, the metric must be complete. For let  $C$  be a compact subset of  $M$  that maps surjectively onto  $M/H$ . We may enlarge  $C$  to a compact codimension-zero submanifold  $C'$  such that every point of  $M$  has a translate which lies in  $C'$  at distance at least a fixed  $\epsilon$  from the frontier of  $C'$ . Then, any Cauchy sequence in  $M$  can be translated, except for finitely many terms, into a Cauchy sequence in  $C'$ . Since  $C'$  is compact, this converges, so the original sequence also converged.  $\square$

**PROPOSITION 3.5.7.** *Suppose that  $H$  acts properly discontinuously on a locally compact connected Hausdorff space  $X$ , and that  $X/H$  is compact. Then  $H$  is finitely generated.*

**PROOF.** Using local compactness, there exists a compact set  $C$  whose interior maps surjectively to  $X/H$ . Let  $H_0$  be the subgroup generated by the finitely many elements  $h$  such that  $h(C) \cap C$  is nonempty. The union of the  $H_0$ -translates of  $C$  is an open and closed subset, so must equal  $X$ . This implies that  $H = H_0$ .  $\square$

**DEFINITION 3.5.8.** Let  $A$  be an  $H$ -invariant subset of  $\tilde{\mathcal{O}}$ . Define  $(C^\infty)_H^A(\tilde{\mathcal{O}})$  to be the elements of  $C_H^\infty(\tilde{\mathcal{O}})$  that fix each point not in  $A$ , and define  $\text{Diff}_H^A(\tilde{\mathcal{O}})$  similarly. If  $A$  is a neighborhood of  $\tilde{\mathcal{W}}$ , define  $\text{Emb}_H^A(\tilde{\mathcal{W}}, \tilde{\mathcal{O}})$  to be the elements of  $\text{Emb}_H(\tilde{\mathcal{W}}, \tilde{\mathcal{O}})$  that carry  $\tilde{\mathcal{W}}$  into  $A$ . We use this notation to extend our previous concepts to orbifolds. For example, if  $K$  is a neighborhood of a suborbifold  $\mathcal{W}$  in  $\mathcal{O}$ , then  $\text{Emb}^K(\mathcal{W}, \mathcal{O})$  is the subspace of  $\text{Emb}(\mathcal{W}, \mathcal{O})$  induced by elements of  $\text{Emb}_H^{\pi^{-1}(K)}(\tilde{\mathcal{W}}, \tilde{\mathcal{O}})$ ,  $\mathcal{X}^K(\mathcal{O}, T\mathcal{O})$  is the subspace of elements of  $\mathcal{X}_H^K(\mathcal{O}, T\mathcal{O})$  that equal  $Z$  outside of  $\pi^{-1}(K)$ , and so on.

**LEMMA 3.5.9.** *Suppose that  $H$  acts properly discontinuously as isometries on  $\tilde{\mathcal{O}}$ . Let  $\tilde{K}$  be an  $H$ -invariant subset of  $\tilde{\mathcal{O}}$  whose quotient in  $\mathcal{O}$  is compact. Then there exists a neighborhood  $J$  of  $1_{\tilde{\mathcal{O}}}$  in  $(C^\infty)_H^{\tilde{K}}(\tilde{\mathcal{O}})$  that consists of diffeomorphisms.*

**PROOF.** Assume for now that  $\mathcal{O}$  is compact and  $\tilde{\mathcal{O}} = \tilde{K}$ , and fix a compact set  $C$  in  $\tilde{\mathcal{O}}$  that maps surjectively to  $\mathcal{O}$ .

We claim that if  $f \in C_H^\infty(\tilde{\mathcal{O}})$  is close enough to  $1_{\tilde{\mathcal{O}}}$ , then  $f$  commutes with the  $H$ -action. By Proposition 3.5.7,  $H$  is finitely generated. Choose an  $x \in \tilde{\mathcal{O}}$  which is not fixed by any nontrivial element of  $H$ . Define  $\Phi: (C^\infty)_H^{\tilde{K}}(\tilde{\mathcal{O}}) \rightarrow \text{End}(H)$  by sending  $f$  to  $\phi_f$  where  $f(h(x)) = \phi_f(h)f(x)$ . This is independent of the choice of  $x$ , and is a homomorphism. If  $f$  is close enough to  $1_{\tilde{\mathcal{O}}}$  on  $\{x, h_1(x), \dots, h_n(x)\}$ , where  $\{h_1, \dots, h_n\}$  generates  $H$ , then  $\phi_f = 1_H$ . This prove the claim.

For the remainder of the argument, we require  $f$  to be close enough to  $1_{\tilde{\mathcal{O}}}$  to ensure that  $f$  commutes with the  $H$ -action. This implies that  $f^{-1}(S)$  is compact whenever  $S$  is compact. For if  $S$  is a subset for which  $f^{-1}(S)$  meets infinitely many translates of  $C$ , then  $S$  meets infinitely many translates of  $f(C)$ , so  $S$  cannot be compact.

Requiring in addition that  $f$  be sufficiently  $C^\infty$ -close to  $1_{\tilde{\mathcal{O}}}$ , we have  $f_*$  nonsingular at each point of  $C$ , hence on all of  $\tilde{\mathcal{O}}$ . Since  $f$  takes boundary to boundary, it follows that  $f$  is a local diffeomorphism. Since inverse images of compact sets under  $f$  are compact,  $f$  is a covering map. And since  $\tilde{\mathcal{O}}$  is simply-connected,  $f$  is a diffeomorphism.

Now suppose that  $\mathcal{O}$  is noncompact. Choose a compact codimension-zero suborbifold  $\mathcal{L}$  of  $\mathcal{O}$  that contains  $\tilde{K}/H$  in its topological interior. Each element of  $(C^\infty)_H^{\tilde{K}}(\tilde{\mathcal{L}})$  extends to an element of  $(C^\infty)_H^{\tilde{K}}(\tilde{\mathcal{O}})$  by using the identity on  $\tilde{\mathcal{O}} - \tilde{\mathcal{L}}$ . Applying the case when  $\mathcal{O}$  is compact, that is, using  $\tilde{\mathcal{L}}$  in place of  $\mathcal{O}$ , some neighborhood of the identity in  $(C^\infty)_H(\tilde{\mathcal{L}})$  consists of maps which are diffeomorphisms on  $\tilde{\mathcal{L}}$ . The intersection of this neighborhood with  $(C^\infty)_H^{\tilde{K}}(\tilde{\mathcal{L}})$  consists of diffeomorphisms, and their extensions to  $\tilde{\mathcal{O}}$  form the desired neighborhood of the identity in  $(C^\infty)_H^{\tilde{K}}(\tilde{\mathcal{O}})$ .  $\square$

We now prove the analogues of Lemmas 3.1.5 and 3.1.6 for vector fields on  $\mathcal{O}$ . Assume that  $\mathcal{W}$  is a compact suborbifold of  $\mathcal{O}$ .

LEMMA 3.5.10 (Equivariant Logarithm Lemma). *There are a neighborhood  $U$  of the inclusion  $i_{\tilde{\mathcal{W}}}$  of  $\tilde{\mathcal{W}}$  into  $\tilde{\mathcal{O}}$  in  $\text{Emb}_H(\tilde{\mathcal{W}}, \tilde{\mathcal{O}})$  and a continuous map  $X: U \rightarrow \mathcal{X}_H(\tilde{\mathcal{W}}, T\tilde{\mathcal{O}})$  such that for all  $j \in U$ ,  $\text{Exp}(X(j)(x))$  is defined for all  $x \in \tilde{\mathcal{W}}$  and  $\text{Exp}(X(j)(x)) = j(x)$  for all  $x \in \tilde{\mathcal{W}}$ . Moreover,  $X(i_{\tilde{\mathcal{W}}}) = Z$ .*

PROOF. Replacing  $\mathcal{O}$  by a compact orbifold neighborhood of  $\mathcal{W}$  and using Lemma 3.5.6, we may assume that  $H$  acts as isometries on  $\tilde{\mathcal{O}}$ , that the metric is a product near  $\partial\tilde{\mathcal{O}}$ , and that  $\tilde{\mathcal{W}}$  meets the collar  $\partial\tilde{\mathcal{O}} \times I$  in  $I$ -fibers. The proof then follows the argument of Lemma 3.1.5, working equivariantly in  $\tilde{\mathcal{O}}$ .  $\square$

LEMMA 3.5.11 (Equivariant Extension Lemma). *Let  $\mathcal{W}$  be a compact suborbifold of  $\mathcal{O}$ . Let  $L$  be a neighborhood of  $\mathcal{W}$  in  $\mathcal{O}$  and let  $S$  be a closed neighborhood in  $\partial\mathcal{O}$  of  $S \cap \partial\mathcal{W}$ . Denote the inverse images in  $\tilde{\mathcal{O}}$  by  $\tilde{L}$  and  $\tilde{S}$ . Then there exists a continuous map  $k: \mathcal{X}_H(\tilde{\mathcal{W}}, T\tilde{\mathcal{O}}) \rightarrow \mathcal{X}_H^{\tilde{L}}(\tilde{\mathcal{O}}, T\tilde{\mathcal{O}})$  such that  $k(X)(x) = X(x)$  for all  $x$  in  $\tilde{\mathcal{W}}$ . Moreover,  $k(Z) = Z$ , and if  $X(x) = Z(x)$  for all  $x \in \tilde{S} \cap \partial\tilde{\mathcal{W}}$ , then  $k(X)(x) = Z(x)$  for all  $x \in \tilde{S}$ .*

PROOF. Assume first that  $\mathcal{W}$  has positive codimension. Replacing  $\mathcal{O}$  by a compact orbifold neighborhood  $\mathcal{O}'$  of  $\mathcal{W}$ ,  $L$  by a compact neighborhood of  $\mathcal{W}$  in  $L \cap \mathcal{O}'$ , and  $S$  by  $S \cap \mathcal{O}'$ , and using Lemma 3.5.6, we may assume that  $H$  acts as isometries on  $\tilde{\mathcal{O}}$ , that the metric is a product near  $\partial\tilde{\mathcal{O}}$ , and that  $\tilde{\mathcal{W}}$  meets the collar  $\partial\tilde{\mathcal{O}} \times I$  in  $I$ -fibers. Let  $\nu(\tilde{\mathcal{W}})$  be the normal bundle, regarded as a subbundle of the restriction of  $T\tilde{\mathcal{O}}$  to  $\tilde{\mathcal{W}}$ . For  $\epsilon > 0$ , let  $\nu_\epsilon(\tilde{\mathcal{W}})$  be the subspace of all vectors of length less than  $\epsilon$ . Since  $\tilde{\mathcal{W}}$  is compact and  $H$  acts as isometries on  $\tilde{L}$ ,  $\text{Exp}$  embeds  $\nu_\epsilon(\tilde{\mathcal{W}})$  as a tubular neighborhood of  $\tilde{\mathcal{W}}$  for sufficiently small  $\epsilon$ . By choosing  $\epsilon$  small enough, we may assume that  $\text{Exp}(\nu_\epsilon(\tilde{\mathcal{W}})) \subset \tilde{L}$ , that the fibers at points in  $\tilde{S}$  map into  $\tilde{S}$ , and that the fibers at points in  $\partial\tilde{\mathcal{O}} - \tilde{S}$  map into  $\partial\tilde{\mathcal{O}} - \tilde{S}$ .

Now use Lemma 3.5.5 to choose an  $H$ -equivariant smooth function  $\alpha: \tilde{\mathcal{O}} \rightarrow [0, 1]$  which is identically equal to 1 on  $\tilde{\mathcal{W}}$  and has support in  $\text{Exp}(\nu_{\epsilon/2}(\tilde{\mathcal{W}}))$ . The extension  $k(X)$  can now be defined exactly as in Lemma 3.1.6. Note that since  $H$  acts as isometries, the parallel translation function  $P$  is  $H$ -equivariant, and the  $H$ -equivariance of  $k(X)$  follows easily.

Assume now that  $\mathcal{W}$  has codimension zero. The frontier  $W$  of  $\tilde{\mathcal{W}}$  is an equivariant properly embedded submanifold of  $\tilde{\mathcal{O}}$ . Since  $H$  acts as isometries, we can select an equivariant tubular neighborhood of  $W$  parameterized as  $W \times (-\infty, \infty)$  with  $\tilde{\mathcal{W}} \cap (W \times (-\infty, \infty)) = W \times [0, \infty)$ , and so that the action of  $H$  respects the  $(-\infty, \infty)$ -coordinate. By Lemma 2.3.2, there is a continuous linear extension operator carrying each vector field on  $\tilde{\mathcal{W}}$  to a vector field on  $\tilde{\mathcal{W}} \cup (W \times (-\infty, \infty))$ . The extended vector fields are equivariant since they are defined by a formula in terms of the coordinates of  $W \times [0, \infty)$ . At points of  $\partial\tilde{\mathcal{O}}$ , the component of each vector in the direction perpendicular to  $\partial\tilde{\mathcal{O}}$  is 0, so the extended component is also 0 and therefore the extended vector fields are also tangent to the boundary. After multiplying by an equivariant function on  $\tilde{\mathcal{W}} \cup (W \times (-\infty, \infty))$  that is 1 on  $\tilde{\mathcal{W}}$  and 0 on  $W \times (-\infty, -1]$ , these vector fields extend using  $Z$  on  $\tilde{\mathcal{O}} - (\mathcal{W} \cup (W \times (-\infty, \infty)))$ .  $\square$

Now we are ready for the analogue of Theorem B of [51]. Its statement and proof use some notation explained in Definition 3.5.8.

**THEOREM 3.5.12.** *Let  $\mathcal{W}$  be a compact suborbifold of  $\mathcal{O}$ . Let  $S$  be a closed neighborhood in  $\partial\mathcal{O}$  of  $S \cap \partial\mathcal{W}$ , and let  $L$  be a neighborhood of  $\mathcal{W}$  in  $\mathcal{O}$ . Then  $\text{Emb}^L(\mathcal{W}, \mathcal{O} \text{ rel } S)$  admits local  $\text{Diff}^L(\mathcal{O} \text{ rel } S)$  cross-sections.*

PROOF. By Proposition 3.1.4, it suffices to find a local cross-section at the inclusion  $i_{\mathcal{W}}$ . Choose a compact neighborhood  $K$  of  $\mathcal{W}$  with  $K \subseteq L$ . Using Lemmas 3.5.10 and 3.5.11, we obtain an open neighborhood  $\tilde{V}$  of  $i_{\tilde{\mathcal{W}}}$  in  $\text{Emb}_H(\tilde{\mathcal{W}}, \tilde{\mathcal{O}})$  and continuous maps  $X: \tilde{V} \rightarrow \mathcal{X}_H(\tilde{\mathcal{W}}, T\tilde{\mathcal{O}})$  and  $k: \mathcal{X}_H(\tilde{\mathcal{W}}, T\tilde{\mathcal{O}}) \rightarrow \mathcal{X}_H^L(\tilde{\mathcal{O}}, T\tilde{\mathcal{O}})$ . By Lemma 3.5.9, there is a neighborhood  $J$  of  $1_{\tilde{\mathcal{O}}}$  in  $(C^\infty)_H^K(\tilde{\mathcal{O}})$  that consists of diffeomorphisms.

On a sufficiently small neighborhood  $\tilde{U}$  of  $i_{\tilde{\mathcal{W}}}$ , the function  $\tilde{\chi}: \tilde{U} \rightarrow \text{Diff}_H^K(\tilde{\mathcal{O}})$  defined by  $\tilde{\chi}(j) = \text{TExp} \circ k \circ X(j)$  is defined and has image in  $J$ . Let  $U$  be the embeddings of  $\mathcal{W}$  in  $\mathcal{O}$  which admit a lift to  $\tilde{U}$ . By choosing  $\tilde{U}$  small enough, we may ensure that the lift of an element of  $U$  is unique. Define  $\chi: U \rightarrow \text{Diff}^K(\mathcal{O})$  to be  $\tilde{\chi}$  applied to the lift of an element of  $U$  to  $\tilde{U}$ , followed by the projection of  $\text{Diff}_H^K(\tilde{\mathcal{O}})$  to  $\text{Diff}^K(\mathcal{O})$ .

For elements in  $U \cap \text{Emb}^K(\mathcal{W}, \mathcal{O} \text{ rel } S)$ , each lift to  $\tilde{U}$  that is sufficiently close to  $i_{\tilde{\mathcal{W}}}$  must agree with  $i_{\tilde{\mathcal{W}}}$  on  $\tilde{S}$ . So  $U$  may be chosen small enough so that if  $j \in U$  then its lift  $\tilde{j}$  in  $\tilde{U}$  lies in  $\text{Emb}(\tilde{\mathcal{W}}, \tilde{\mathcal{O}} \text{ rel } \tilde{S})$ . Then,  $X(\tilde{j}(x)) = Z(x)$  for all  $x \in \tilde{S}$ , so  $k(X)(x) = Z(x)$  for all  $x \in \tilde{S}$ . It follows that  $\chi(j) \in \text{Diff}(\mathcal{O} \text{ rel } S)$ .  $\square$

COROLLARY 3.5.13. *Let  $\mathcal{W}$  be a compact suborbifold of  $\mathcal{O}$ , which is either properly embedded or codimension-zero. Let  $S$  be a closed neighborhood in  $\partial\mathcal{O}$  of  $S \cap \partial\mathcal{W}$ , and let  $L$  be a neighborhood of  $\mathcal{W}$  in  $\mathcal{O}$ . Then the restriction  $\text{Diff}^L(\mathcal{O} \text{ rel } S) \rightarrow \text{Emb}^L(\mathcal{W}, \mathcal{O} \text{ rel } S)$  is locally trivial.*

COROLLARY 3.5.14. *Let  $\mathcal{V}$  and  $\mathcal{W}$  be suborbifolds of  $\mathcal{O}$ , with  $\mathcal{W} \subset \mathcal{V}$ . Assume that  $\mathcal{W}$  compact, and is either properly embedded or codimension-zero. Let  $S$  be a closed neighborhood in  $\partial\mathcal{O}$  of  $S \cap \partial\mathcal{W}$ , and let  $L$  be a neighborhood of  $\mathcal{W}$  in  $\mathcal{O}$ . Then the restriction  $\text{Emb}^L(\mathcal{V}, \mathcal{O} \text{ rel } S) \rightarrow \text{Emb}^L(\mathcal{W}, \mathcal{O} \text{ rel } S)$  is locally trivial.*

### 3.6. Singular fiberings

Throughout this section,  $\Sigma$  and  $\mathcal{O}$  denote compact connected orbifolds, in the sense of Section 3.5.

DEFINITION 3.6.1. A continuous surjection  $p: \Sigma \rightarrow \mathcal{O}$  is called a *singular fibering* if there exists a commutative diagram

$$\begin{array}{ccc} \tilde{\Sigma} & \xrightarrow{\tilde{p}} & \tilde{\mathcal{O}} \\ \downarrow \sigma & & \downarrow \tau \\ \Sigma & \xrightarrow{p} & \mathcal{O} \end{array}$$

in which

- (i)  $\tilde{\Sigma}$  and  $\tilde{\mathcal{O}}$  are manifolds, and  $\sigma$  and  $\tau$  are regular orbifold coverings with groups of covering transformations  $G$  and  $H$  respectively,
- (ii)  $\tilde{p}$  is surjective and locally trivial, and
- (iii) the fibers of  $p$  and  $\tilde{p}$  are path-connected.

The class of singular fiberings includes many Seifert fiberings, for example all compact 3-dimensional Seifert manifolds  $\Sigma$  except the lens spaces with one or two exceptional orbits (see for example [60]). For some of those lens spaces,  $\mathcal{O}$  fails to have an orbifold covering by a manifold. On the other hand, it is a much larger class than Seifert fiberings, because no structure as a homogeneous space is required on the fiber.

For mappings there is a complete analogy with the bundle case, where now  $\text{Diff}_f(\Sigma)$  is by definition the quotient of the group of fiber-preserving  $G$ -equivariant diffeomorphisms  $(\text{Diff}_G)_f(\tilde{\Sigma})$  by its normal subgroup  $G$ , and so on. A suborbifold  $W$  of  $\Sigma$  is called *vertical* if it is a union of fibers. In this case the inverse image  $\tilde{W}$  of  $W$  in  $\tilde{\Sigma}$  is a vertical submanifold, and we write  $\text{Emb}_f(W, \Sigma)$  for embeddings induced by elements of  $(\text{Emb}_G)_f(\tilde{W}, \tilde{\Sigma})$ ,  $\text{Emb}_v(W, \Sigma)$  for embeddings induced by elements of  $(\text{Emb}_G)_v(\tilde{W}, \tilde{\Sigma})$ , and so on.

Following our usual notations, we put  $\partial_v \Sigma = p^{-1}(\partial \mathcal{O})$ ,  $\partial_v W = W \cap \partial_v \Sigma$ ,  $\partial_h \Sigma = \overline{\partial \Sigma} - \partial_v \Sigma$ , and  $\partial_h W = \partial W \cap \partial_h \Sigma$ .

Since  $\mathcal{O}$  is compact, Lemma 3.5.6 shows that a (complete) Riemannian metric on  $\tilde{\mathcal{O}}$  can be chosen so that  $H$  acts as isometries, and moreover so that the metric on  $\tilde{\mathcal{O}}$  is a product near the boundary. Next we will sketch how to obtain a  $G$ -equivariant metric which is a product near  $\partial_h \tilde{\Sigma}$  and near  $\partial_v \tilde{\Sigma}$ . If  $\partial_h \tilde{\Sigma}$  is empty, we simply apply Lemma 3.5.6. Assume that  $\partial_h \tilde{\Sigma}$  is nonempty. Construct a  $G$ -equivariant collar of  $\partial_h \tilde{\Sigma}$ , and use it to obtain a  $G$ -equivariant metric such that the I-fibers of  $\partial_h \tilde{\Sigma} \times \text{I}$  are vertical. If  $\partial_v \tilde{\Sigma}$  is also nonempty, put  $Y = \partial_h \tilde{\Sigma} \cap \partial_v \tilde{\Sigma}$ . We will follow the construction in the last paragraph of Section 2.6. Denote the collar of  $\partial_h \tilde{\Sigma}$  by  $\partial_h \tilde{\Sigma} \times [0, 2]_1$ . Assume that the metric on  $\partial_h \tilde{\Sigma}$  was a product on a collar  $Y \times [0, 2]_2$  of  $Y$  in  $\partial_h \tilde{\Sigma}$ . Next, construct a  $G$ -equivariant collar  $\partial_v \tilde{\Sigma} \times [0, 2]_2$  of  $\partial_v \tilde{\Sigma}$  whose  $[0, 2]_2$ -fiber at each point of  $Y \times [0, 2]_1$  agrees with the  $[0, 2]_2$ -fiber of the collar of  $Y$  in  $\partial_h \tilde{\Sigma} \times \{t\}$ . Then, the product metric on  $\partial_v \tilde{\Sigma} \times [0, 2]_2$  agrees with the product metric of  $\partial_h \tilde{\Sigma} \times [0, 2]_1$  where they overlap, and the  $G$ -equivariant patching can be done to obtain a metric which is a product near  $\partial_v \tilde{\Sigma}$  without losing the property that it is a product near  $\partial_h \tilde{\Sigma}$ . We will always assume



that the metrics have been selected with these properties. By the first sentence of the next lemma,  $G$  preserves the vertical and horizontal parts of vectors.

Some basic observations about singular fiberings will be needed.

LEMMA 3.6.2. *The action of  $G$  preserves the fibers of  $\tilde{p}$ . Moreover:*

- (i) *If  $g \in G$ , then there exists an element  $h \in H$  such that  $\tilde{p}g = h\tilde{p}$ .*
- (ii) *If  $h \in H$ , then there exists an element  $g$  of  $G$  such that  $\tilde{p}g = h\tilde{p}$ .*
- (iii) *If  $x \in \Sigma$ , then  $\tau^{-1}p(x) = \tilde{p}\sigma^{-1}(x)$ .*

PROOF. Suppose that  $\tilde{p}(x) = \tilde{p}(y)$ . For  $g \in G$ , we have  $\tau\tilde{p}(g(x)) = p\sigma(g(x)) = p\sigma(x) = \tau\tilde{p}(x) = \tau\tilde{p}(y) = \tau\tilde{p}(g(y))$ . Since the fibers of  $\tilde{p}$  are path-connected, and the fibers of  $\tau$  are discrete, this implies that  $g(x)$  and  $g(y)$  lie in the same fiber of  $\tilde{p}$ . For (i), let  $g \in G$ . Since  $g$  preserves the fibers of  $\tilde{p}$ , it induces a map  $h$  on  $\tilde{\mathcal{O}}$ . Given  $x \in \tilde{\mathcal{O}}$ , choose  $y \in \tilde{\Sigma}$  with  $\tilde{p}(y) = x$ . Then  $\tau h(x) = \tau\tilde{p}(g(y)) = p\sigma(g(y)) = p\sigma(y) = \tau\tilde{p}(y) = \tau(x)$  so  $h \in H$ .

To prove (ii), suppose  $h$  is any element of  $H$ . Let  $\text{sing}(\mathcal{O})$  denote the singular set of  $\mathcal{O}$ . Choose  $a \in \tilde{\mathcal{O}} - \tau^{-1}(\text{sing}(\mathcal{O}))$ , choose  $s \in \tilde{\Sigma}$  with  $\tilde{p}(s) = a$ , and choose  $s'' \in \tilde{\Sigma}$  with  $\tilde{p}(s'') = h(a)$ . Since  $p\sigma(s) = \tau\tilde{p}(s) = \tau\tilde{p}(s'') = p\sigma(s'')$ ,  $\sigma(s)$  and  $\sigma(s'')$  must lie in the same fiber of  $p$ . Since the fiber is path-connected, there exists a path  $\beta$  in that fiber from  $\sigma(s'')$  to  $\sigma(s)$ . Let  $\tilde{\beta}$  be its lift in  $\tilde{\Sigma}$  starting at  $s''$  and let  $s'$  be the endpoint of this lift, so that  $\sigma(s') = \sigma(s)$ . Note that  $\tilde{p}(s') = \tilde{p}(s'') = h(a)$  since  $\tilde{\beta}$  lies in a fiber of  $\tilde{p}$ . Since  $\sigma(s) = \sigma(s')$ , there exists a covering transformation  $g \in G$  with  $g(s) = s'$ . To show that  $\tilde{p}g = h\tilde{p}$ , it is enough to verify that they agree on the dense set  $\tilde{p}^{-1}(\tilde{\mathcal{O}} - \tau^{-1}(\text{sing}(\mathcal{O})))$ . Let  $t \in \tilde{p}^{-1}(\tilde{\mathcal{O}} - \tau^{-1}(\text{sing}(\mathcal{O})))$  and choose a path  $\gamma$  in  $\tilde{p}^{-1}(\tilde{\mathcal{O}} - \tau^{-1}(\text{sing}(\mathcal{O})))$  from  $s$  to  $t$ . Since  $g \in G$ , we have  $p\sigma g = p\sigma g\gamma$ . Therefore  $\tau\tilde{p}\gamma = \tau\tilde{p}g\gamma$ , and so  $\tilde{p}g\gamma$  is the unique lift of  $p\sigma g$  starting at  $\tilde{p}g(s) = h(a)$ . But this lift equals  $h\tilde{p}\gamma$ , so  $h\tilde{p}(t) = \tilde{p}g(t)$ .

For (iii), fix  $z_0 \in \sigma^{-1}(x)$  and let  $y_0 = \tilde{p}(z_0)$ . Suppose  $y \in \tilde{p}\sigma^{-1}(x)$ . Choose  $z \in \sigma^{-1}(x)$  with  $\tilde{p}(z) = y$ . Since  $\sigma$  is a regular covering, there exists  $g \in G$  such that  $g(z) = z_0$ . By (i),  $g$  induces  $h$  on  $\tilde{\mathcal{O}}$ , and  $h(y) = h\tilde{p}(z) = \tilde{p}g(z) = \tilde{p}(z_0) = y_0$ . Therefore  $\tau(y) = \tau(h(y)) = \tau(y_0) = \tau\tilde{p}(z_0) = p\sigma(z_0) = p(x)$  so  $y \in \tau^{-1}(p(x))$ . For the opposite inclusion, suppose that  $y \in \tau^{-1}(p(x))$ , so  $\tau(y) = p(x) = \tau(y_0)$ . Since  $\sigma$  is regular, there exists  $h \in H$  such that  $h(y_0) = y$ . Let  $g$  be as in (ii). Then  $y = h(y_0) = h\tilde{p}(z_0) = \tilde{p}g(z_0)$ , and  $\sigma(g(z_0)) = \sigma(z_0) = x$  so  $y \in \tilde{p}(\sigma^{-1}(x))$ .  $\square$

One consequence of Lemma 3.6.2 is that there is a unique surjective homomorphism  $\phi: G \rightarrow H$  with respect to which  $\tilde{p}$  is equivariant:  $\tilde{p}(gx) = \phi(g)(\tilde{p}(x))$ .

A second consequence of Lemma 3.6.2 is that provided that  $G$  acts as isometries, the aligned exponential  $\text{Exp}_a$  for the bundle  $\tilde{p}: \tilde{\Sigma} \rightarrow \tilde{\mathcal{O}}$  is  $G$ -equivariant. Consequently, the aligned tame exponential  $\text{TExp}_a$  takes  $G$ -equivariant vector fields on  $\tilde{\Sigma}$  to  $G$ -equivariant smooth maps of  $\tilde{\Sigma}$ .

**THEOREM 3.6.3.** *Let  $S$  be a closed subset of  $\mathcal{O}$ , and let  $T = p^{-1}(S)$ . Then  $\text{Diff}(\mathcal{O} \text{ rel } S)$  admits local  $\text{Diff}_f(\Sigma \text{ rel } T)$  cross-sections.*

**PROOF.** By Proposition 3.1.4, we only need a local  $\text{Diff}_f(\Sigma \text{ rel } T)$  cross-section at  $1_{\mathcal{O}}$ .

Applying Lemma 3.5.10 with  $\tilde{\mathcal{W}} = \tilde{\mathcal{O}}$  provides a neighborhood  $\tilde{U}$  of  $1_{\tilde{\mathcal{O}}}$  in  $\text{Diff}_H(\tilde{\mathcal{O}} \text{ rel } \tau^{-1}(S))$  and  $X: \tilde{U} \rightarrow \mathcal{X}_H(\tilde{\mathcal{O}}, T\tilde{\mathcal{O}})$  such that  $\text{Exp}(X(j)(y)) = j(y)$  for all  $y \in \tilde{\mathcal{O}}$ , and  $X(j)(y) = Z(y)$  for all  $y \in \tau^{-1}(S)$ . Define  $\tilde{X}: \tilde{U} \rightarrow \mathcal{X}(\tilde{\Sigma}, T\tilde{\Sigma})$  by taking horizontal lifts, that is,

$$\tilde{X}(j)(x) = (\tilde{p}|_{H_x})_*^{-1}(X(j)(\tilde{p}(x))) .$$

We claim that  $\tilde{X}(j)$  lies in  $\mathcal{A}_G(\tilde{\Sigma}, T\tilde{\Sigma})$ . To verify the boundary tangency conditions, we observe that  $\tilde{X}(j)$  must be tangent to the vertical boundary since it is a lift of a vector tangent to the boundary of  $\tilde{\mathcal{O}}$ , and tangent to the horizontal boundary since it is horizontal. Since  $\text{Exp}(X(j)(y))$  is defined at all points of  $\tilde{\mathcal{O}}$ , and  $\tilde{X}(j)$  is horizontal, each  $\text{Exp}_a(\tilde{X}(j)(x))$  exists. To check equivariance, let  $g \in G$ . By Lemma 3.6.2, there exists  $h \in H$  such that  $\tilde{p}g = h\tilde{p}$ . We then have

$$\begin{aligned} \tilde{X}(j)(g(x)) &= (\tilde{p}|_{H_x})_*^{-1}(X(j)(\tilde{p}(g(x)))) \\ &= (\tilde{p}|_{H_x})_*^{-1}(X(j)(h\tilde{p}(x))) \\ &= (\tilde{p}|_{H_x})_*^{-1}(h_*(X(j)(\tilde{p}(x)))) \\ &= g_*(\tilde{p}|_{H_x})_*^{-1}(X(j)(h\tilde{p}(x))) \\ &= g_*\tilde{X}(j)(x) . \end{aligned}$$

Note also that  $\tilde{X}(j)(x) = Z(x)$  for every  $x \in \tilde{p}^{-1}\tau^{-1}(S)$ , since  $X(j)(y) = Z(y)$  for every  $y \in \tau^{-1}(S)$ . Using Lemma 3.5.9, we may pass to a smaller  $\tilde{U}$  if necessary to assume that  $\text{TExp}_a \circ \tilde{X}: \tilde{U} \rightarrow \text{Diff}_G(\tilde{\Sigma} \text{ rel } \tilde{p}^{-1}\tau^{-1}(S))$ .

Since  $\tau: \tilde{\mathcal{O}} \rightarrow \mathcal{O}$  is an orbifold covering map, there exists a neighborhood of  $1_{\tilde{\mathcal{O}}}$  in  $\text{Diff}_H(\tilde{\mathcal{O}})$  such that no two elements in this neighborhood induce the same diffeomorphism on  $\mathcal{O}$ . Intersecting this neighborhood with  $\tilde{U}$ , we may assume that  $\tilde{U}$  has the same property.

By definition, each  $f \in \text{Diff}(\mathcal{O})$  has lifts to elements of  $\text{Diff}_H(\tilde{\mathcal{O}})$ . If  $f$  lies in some sufficiently small neighborhood  $U$  of  $1_{\mathcal{O}}$ , then it has a lift in  $\tilde{U}$ . This lift is unique, by our selection of  $\tilde{U}$ , and we denote it by  $\tilde{f}$ . Define  $\chi: U \rightarrow \text{Diff}(\Sigma \text{ rel } T)$  by letting  $\chi(f)$  be the diffeomorphism induced on  $\Sigma$  by  $\text{TExp}_a \circ \tilde{X}(\tilde{f})$ . Let  $y \in \mathcal{O}$ , choose  $\tilde{y} \in \tilde{\mathcal{O}}$  with  $\tau(\tilde{y}) = y$ , and  $\tilde{x} \in \tilde{\Sigma}$  with  $\tilde{p}(\tilde{x}) = \tilde{y}$ . Then we have

$$\begin{aligned} (\chi(f) \cdot 1_{\mathcal{O}})(y) &= \overline{\chi(f)}(y) = \overline{\chi(f)}(\tau \circ \tilde{p}(\tilde{x})) = \overline{\chi(f)}(p \circ \sigma(\tilde{x})) \\ &= p \circ \chi(f)(\sigma(\tilde{x})) = p \circ \sigma \circ \text{TExp}_a \circ \tilde{X}(\tilde{f})(\tilde{x}) = \tau \circ \tilde{p} \circ \text{TExp}_a \circ \tilde{X}(\tilde{f})(\tilde{x}) \\ &= \tau \circ \text{Exp} \circ \tilde{p}_* \circ \tilde{X}(\tilde{f})(\tilde{x}) = \tau \circ \text{Exp} \circ X(\tilde{f})(\tilde{y}) = \tau \circ \tilde{f}(y) = f(y) \end{aligned}$$

as required.  $\square$

Applying Proposition 3.1.2, we have immediately

**THEOREM 3.6.4.** *Let  $S$  be a closed subset of  $\mathcal{O}$ , and let  $T = p^{-1}(S)$ . Then  $\text{Diff}_f(\Sigma \text{ rel } T) \rightarrow \text{Diff}(\mathcal{O} \text{ rel } S)$  is locally trivial.*

We now examine Lemmas 3.3.1 and 3.3.2 in the singular fibered case. There is no difficulty in adapting Lemma 3.3.1 equivariantly:

**LEMMA 3.6.5** (Logarithm Lemma for singular fiberings). *Let  $W$  be a vertical suborbifold of  $\Sigma$ . Then there are an open neighborhood  $U$  of the inclusion  $i_{\tilde{W}}$  in  $(\text{Emb}_f)_G(\tilde{W}, \tilde{\Sigma})$  and a continuous map  $X: U \rightarrow \mathcal{A}_G(\tilde{W}, T\tilde{\Sigma})$  such that for all  $j \in U$ ,  $\text{Exp}_a(X(j)(x))$  is defined for all  $x \in \tilde{W}$  and  $\text{Exp}_a(X(j)(x)) = j(x)$  for all  $x \in \tilde{W}$ . Also,  $X(i_{\tilde{W}}) = Z$ .*

**LEMMA 3.6.6** (Extension Lemma for singular fiberings). *Let  $W$  be a vertical suborbifold of  $\Sigma$ , and  $T$  a closed fibered neighborhood in  $\partial_v \Sigma$  of  $T \cap \partial_v W$ . Then there exists a continuous linear map  $k: \mathcal{A}_G(\tilde{W}, T\tilde{\Sigma}) \rightarrow \mathcal{A}_G(\tilde{\Sigma}, T\tilde{\Sigma})$  such that  $k(X)(x) = X(x)$  for all  $X \in \mathcal{A}_G(\tilde{W}, T\tilde{\Sigma})$  and  $x \in \tilde{W}$ . If  $X(x) = Z(x)$  for all  $x \in \tilde{T} \cap \partial_v \tilde{W}$ , then  $k(X)(x) = Z(x)$  for all  $x \in \tilde{T}$ . Moreover,  $k(\mathcal{V}_G(\tilde{W}, T\tilde{\Sigma})) \subset \mathcal{V}_G(\tilde{\Sigma}, T\tilde{\Sigma})$ .*

**PROOF.** We may assume that the metrics on  $\tilde{\Sigma}$  and  $\tilde{\mathcal{O}}$  are  $G$ - and  $H$ -equivariant; in particular,  $G$  takes horizontal subspaces of  $T\tilde{\Sigma}$  to horizontal subspaces. Notice that  $\tilde{p}_*$  carries  $G$ -invariant aligned vector fields to  $H$ -invariant vector fields; this uses Lemma 3.6.2(ii). It

follows that the aligned exponential on  $\tilde{\Sigma}$  is  $G$ -equivariant. For let  $X \in \mathcal{A}_G(T\tilde{\Sigma})$  and let  $g \in G$ . Let  $x \in \tilde{\Sigma}$  and let  $\tilde{F}_x$  be the fiber of  $\tilde{p}$  containing  $x$ . At  $x$ ,  $X(x) = X(x)_v + X(x)_h$ . Since  $g$  is an isometry,  $X(g(x))_v = g_*(X(x)_v)$  and  $X(g(x))_h = g_*(X(x)_h)$ . To find  $\text{Exp}_a(X(x))$ , we first find  $\text{Exp}_v(X(x)_v)$ , that is, exponentiate  $X(x)_v$  using the metric induced on  $\tilde{F}_x$ . This ends at a point  $x' \in \tilde{F}_x$ . Since  $G$  acts as isometries,  $\text{Exp}_v(g_*X(x)_v) = g \text{Exp}_v(X(x)_v) = g(x')$ . Now, use Lemma 3.6.2 to obtain  $\lambda \in H$  with  $\lambda\tilde{p} = \tilde{p}g$ . We have  $\lambda_*\tilde{p}_*(X(x)_h) = \tilde{p}_*(g_*(X(x)_h)) = \tilde{p}_*(X(g(x))_h)$ . Since  $\lambda$  is an isometry, it carries the geodesic in  $\mathcal{O}$  determined by  $\tilde{p}_*(X(x)_h)$  to the geodesic determined by  $\tilde{p}_*(X(g(x))_h)$ . Therefore  $g$  carries the horizontal lift of  $\tilde{p}_*(X(x)_h)$  at  $x'$  to the horizontal lift of  $\tilde{p}_*(X(g(x))_h)$  at  $g(x')$ . So  $g$  carries  $\text{Exp}_a(X(x))$  to  $\text{Exp}_a(X(g(x)))$ .

We can now proceed as in the proof of Lemma 3.3.2. Given a  $G$ -equivariant aligned section on  $W$ , extend the vertical part as in Lemma 3.1.6 and project the extension to the vertical subspace. This process is equivariant since we use a  $G$ -equivariant metric and  $G$ -equivariant functions to taper off the local extensions. For the horizontal part, project to  $\tilde{\mathcal{O}}$ , extend  $H$ -equivariantly using Lemma 3.5.11, and lift.  $\square$

**THEOREM 3.6.7.** *Let  $W$  be a vertical suborbifold of  $\Sigma$ . Let  $T$  be a closed fibered neighborhood in  $\partial_v\Sigma$  of  $T \cap \partial_v W$ . Then*

- (i)  $\text{Emb}_f(W, \Sigma \text{ rel } T)$  admits local  $\text{Diff}_f(\Sigma \text{ rel } T)$  cross-sections, and
- (ii)  $\text{Emb}_v(W, \Sigma \text{ rel } T)$  admits local  $\text{Diff}_v(\Sigma \text{ rel } T)$  cross-sections.

**PROOF.** By Proposition 3.1.4, it suffices to find local cross-sections at the inclusion  $i_W$ .

By Lemma 3.6.5, there are an open neighborhood  $\tilde{U}$  of the inclusion  $i_{\tilde{W}}$  in  $(\text{Emb}_f)_G(\tilde{W}, \tilde{\Sigma})$  and a continuous map  $X: \tilde{U} \rightarrow \mathcal{A}_G(\tilde{W}, T\tilde{\Sigma})$  such that for all  $j \in \tilde{U}$ ,  $\text{Exp}_a(X(j)(x))$  is defined for all  $x \in \tilde{W}$  and  $\text{Exp}_a(X(j)(x)) = j(x)$  for all  $x \in \tilde{W}$ . By Lemma 3.6.6, there exists a continuous linear map  $k: \mathcal{A}_G(\tilde{W}, T\tilde{\Sigma}) \rightarrow \mathcal{A}_G(\tilde{\Sigma}, T\tilde{\Sigma})$  such that  $k(X)(x) = X(x)$  for all  $X \in \mathcal{A}_G(\tilde{W}, T\tilde{\Sigma})$  and  $x \in \tilde{W}$ . Additionally,  $k(X)(x) = Z(x)$  for all  $x \in \tilde{T}$ , and  $k(\mathcal{V}_G(\tilde{W}, T\tilde{\Sigma})) \subset \mathcal{V}_G(\tilde{\Sigma}, T\tilde{\Sigma})$ .

Lemma 3.3.3 now gives a neighborhood  $\tilde{U}_1$  of  $Z$  in  $\mathcal{A}_G(\tilde{\Sigma}, T\tilde{\Sigma})$  such  $\text{Exp}_a(X)$  is defined for all  $X \in \tilde{U}_1$ , and  $\text{TExp}_a$  has image in  $\text{Diff}_f^K(E)$ . Putting  $U = X^{-1} \circ k^{-1}(\tilde{U}_1)$ , the composition  $\text{TExp}_a \circ k \circ X: \tilde{U} \rightarrow \text{Diff}_f^K(E)$  is the desired cross-section for (i).

Since  $X$  carries  $\text{Emb}_v(W, \Sigma)$  into  $\mathcal{V}_G(\widetilde{W}, T\widetilde{\Sigma})$ ,  $k$  carries  $\mathcal{V}_G(\widetilde{W}, T\widetilde{\Sigma})$  into  $\mathcal{V}_G(\widetilde{\Sigma}, T\widetilde{\Sigma})$ , and  $\text{TExp}_a$  carries  $\widetilde{U}_1 \cap \mathcal{V}_G(\widetilde{\Sigma}, T\widetilde{\Sigma})$  into  $\text{Diff}_v(\widetilde{\Sigma})$ , this cross-section restricts on  $\text{Emb}_v(W, \Sigma \text{ rel } T)$  to a  $\text{Diff}_v^L(\Sigma \text{ rel } T)$  cross-section, giving (ii).  $\square$

As in Section 3.4, we have the following immediate corollaries.

**COROLLARY 3.6.8.** *Let  $W$  be a vertical suborbifold of  $\Sigma$ . Let  $T$  be a fibered neighborhood in  $\partial_v \Sigma$  of  $T \cap \partial_v W$ . Then the following restrictions are locally trivial:*

- (i)  $\text{Diff}_f(\Sigma \text{ rel } T) \rightarrow \text{Emb}_f(W, \Sigma \text{ rel } T)$ , and
- (ii)  $\text{Diff}_v(\Sigma \text{ rel } T) \rightarrow \text{Emb}_v(W, \Sigma \text{ rel } T)$ .

**COROLLARY 3.6.9.** *Let  $V$  and  $W$  be vertical suborbifolds of  $\Sigma$ , with  $W \subseteq V$ . Let  $T$  be a closed fibered neighborhood in  $\partial_v \Sigma$  of  $T \cap \partial_v W$ . Then the following restrictions are locally trivial:*

- (i)  $\text{Emb}_f(V, \Sigma \text{ rel } T) \rightarrow \text{Emb}_f(W, \Sigma \text{ rel } T)$ , and
- (ii)  $\text{Emb}_v(V, \Sigma \text{ rel } T) \rightarrow \text{Emb}_v(W, \Sigma \text{ rel } T)$ .

**THEOREM 3.6.10.** *Let  $W$  be a vertical suborbifold of  $\Sigma$ . Let  $T$  be a closed fibered neighborhood in  $\partial_v \Sigma$  of  $T \cap \partial_v W$ , and let  $S = p(T)$ . Then all four maps in the following square are locally trivial:*

$$\begin{array}{ccc} \text{Diff}_f(\Sigma \text{ rel } T) & \longrightarrow & \text{Emb}_f(W, \Sigma \text{ rel } T) \\ \downarrow & & \downarrow \\ \text{Diff}(\mathcal{O} \text{ rel } S) & \longrightarrow & \text{Emb}(p(W), \mathcal{O} \text{ rel } S) . \end{array}$$

### 3.7. Spaces of fibered structures

In this section, we examine spaces of fibered structures.

**DEFINITION 3.7.1.** Let  $p: \Sigma \rightarrow \mathcal{O}$  be a singular fibering. The *space of fibered structures* isomorphic to  $p$ , (also called the *space of singular fiberings* isomorphic to  $p$ ) is the space of cosets  $\text{Diff}(\Sigma)/\text{Diff}_f(\Sigma)$ .

Our proof of the next theorem requires an additional condition, although we do not know that it is necessary:

**DEFINITION 3.7.2.** A singular fibering  $p: \Sigma \rightarrow \mathcal{O}$  is called *very good* if  $\widetilde{\Sigma}$  may be chosen to be compact.

The main result of this section is the following fibration theorem.

**THEOREM 3.7.3.** *Let  $p: \Sigma \rightarrow \mathcal{O}$  be a very good singular fibering. Then the space of fibered structures isomorphic to  $p$  is a Fréchet manifold locally modeled on the quotient  $\mathcal{X}_G(\widetilde{\Sigma}, T\widetilde{\Sigma})/\mathcal{A}_G(\widetilde{\Sigma}, T\widetilde{\Sigma})$ . The quotient map  $\text{Diff}(\Sigma) \rightarrow \text{Diff}(\Sigma)/\text{Diff}_f(\Sigma)$  is a locally trivial fibering.*

Here is the basic idea of the proof. Roughly speaking, finding a local  $\text{Diff}(\Sigma)$  cross-section for  $\text{Diff}(\Sigma)/\text{Diff}_f(\Sigma)$  boils down to the problem of taking an  $h \in \text{Diff}(\Sigma)$  that carries fibers of  $\Sigma$  to fibers that are nearly vertical, and finding, for each fiber  $F$  of  $\Sigma$ , a “nearest” vertical fiber to  $h(F)$ . It is not obvious that such a choice is uniquely determined, but there is a way to make one when  $h$  is sufficiently close to a fiber-preserving diffeomorphism. For then each  $p(h(F))$  lies in a very small open ball set in  $B$ , and  $p(h(F))$  has a unique *center of mass*  $c_{p(h(F))}$ . The natural choice for the nearest fiber to  $h(F)$  is  $p^{-1}(c_{p(h(F))})$ .

Before beginning the proof, we must clarify the idea of center of mass in this context. A useful reference for this is H. Karcher [39], which we will follow here.

Let  $A$  be a measure space of volume 1 and let  $B$  be an open ball in a compact Riemannian manifold  $M$ . By making its radius small enough, we may ensure that the closure  $\overline{B}$  is a geodesically convex ball (that is, any two points in  $\overline{B}$  are connected by a unique geodesic that lies in  $\overline{B}$ ). Let  $f: A \rightarrow M$  be a measurable map such that  $f(A) \subset B$ . Define  $P_f: \overline{B} \rightarrow \mathbb{R}$  by

$$P_f(m) = \frac{1}{2} \int_A d(m, f(a))^2 dA .$$

Various estimates on the gradient of  $P_f$ , detailed in [39], show that  $P_f$  is a convex function that has a unique minimum in  $B$ , and this minimum is defined to be the center of mass  $C_f$  of  $f$ . From its definition,  $C_f$  is independent of the choice of  $B$ , although it is the existence of such a  $B$  that serves to ensure that it is uniquely defined.

**PROOF OF THEOREM 3.7.3.** Consider first the case of an ordinary bundle  $p: E \rightarrow B$  with  $E$  compact. For each  $x \in E$ , the fiber containing  $x$  will be denoted by  $F_x$ . For each coset  $h \text{Diff}_f(E)$ , the set of images  $\{h(F_x)\}$  is independent of the coset representative, and we will refer to these submanifolds as “image fibers”, reserving “fibers” for the original fibers for  $p$ . When the coset  $h \text{Diff}_f(E)$  is clear from the context, the image fiber containing  $x$  will be denoted by  $F'_x$ .

Write  $n$  for the dimension of  $E$  and  $k$  for the dimension of  $B$ . The tangent bundle of  $E$  has an associated bundle  $G_k(TE)$  whose fiber is the Grassmannian of  $k$ -planes in  $\mathbb{R}^n$ , and selecting the horizontal  $k$ -plane at each point defines a section  $s_0: E \rightarrow G_k(TE)$ . The normal subspaces for the image fibering of  $h \text{Diff}_f(E)$  determine another section  $s: E \rightarrow G_k(TE)$ , defining a function  $\text{Diff}(E)/\text{Diff}_f(E) \rightarrow C^\infty(E, G_k(TE))$ . This function is injective, since distinct fiberings must have different normal spaces at some points, so imbeds  $\text{Diff}(E)/\text{Diff}_f(E)$  into the

Fréchet space of sections from  $M$  into  $G_k(TE)$ . This defines the topology on  $\text{Diff}(E)/\text{Diff}_f(E)$ . In particular, we can speak of image fiberings as being  $C^\infty$ -close to vertical, meaning that the section  $s$  is  $C^\infty$ -close to  $s_0$ .

We will first produce local  $\text{Diff}(E)$  cross-sections, then examine the Fréchet structure on  $\text{Diff}(E)/\text{Diff}_f(E)$ . Since  $\text{Diff}(E)$  acts transitively on  $\text{Diff}(E)/\text{Diff}_f(E)$ , it is enough to produce a local cross-section at the identity coset  $1_E \text{Diff}_f(E)$ .

For  $\epsilon > 0$ , denote by  $H_\epsilon(F_x)$  the space of horizontal vectors in  $TE|_{F_x}$  of length less than  $\epsilon$  that are carried into  $E$  by the aligned exponential  $\text{Exp}_a$ . By compactness, there exists an  $\epsilon_0 > 0$  such that for every  $x \in E$ ,  $\text{Exp}_a$  carries  $H_{\epsilon_0}(F_x)$  diffeomorphically onto a tubular neighborhood  $N_{\epsilon_0}(F_x)$  of  $F_x$  in  $E$ . We may also choose  $\epsilon_0$  so that each ball in  $B$  of radius at most  $\epsilon_0$  has convex closure.

By compactness of  $E$ , there exists a neighborhood  $U$  of  $1_E \text{Diff}_f(E)$  in  $\text{Diff}(E)/\text{Diff}_f(E)$  such that for each  $h \text{Diff}_f(E) \in U$ , the image fibering of  $h \text{Diff}_f(E)$  has the following property: For each  $y \in E$ , there exists a fiber  $F_x$  such that  $F'_y \subset N_{\epsilon_0}(F_x)$ , and moreover if  $F_x$  is any such fiber, then  $F'_y$  meets each normal fiber of  $N_{\epsilon_0}(F_x)$  transversely in a single point.

Now we will set up the center-of-mass construction, illustrated in Figure 3.2. Fix a coset  $h \text{Diff}_f(E)$  and an image fiber  $F'_x$ , where  $x = h(y)$  for some  $y$ . Let  $dF'_x$  be the volume form on  $F'_x$  obtained from restriction of the Riemannian metric on  $TE$  to  $TF'_x$ , and define a measure  $\mu_{F'_x}$  on  $F'_x$  of volume 1 by  $\mu_{F'_x}(U) = \text{Vol}(U)/\text{Vol}(F'_x)$ .

Assume now that  $h \text{Diff}_f(E)$  is close enough to vertical that for each image fiber  $F'_x$ ,  $p(F'_x)$  lies in some  $\epsilon_0$ -ball. The center of mass of  $(F'_x, \mu_{F'_x})$  is then defined, and we denote its inverse image, a fiber of  $p$ , by  $V(F'_x)$ .

For each  $z \in E$ , let  $n(z)$  be the point of  $V(F'_z)$  such that the normal fiber of  $N_{\epsilon_0}(V(F'_z))$  at  $n(z)$  contains  $z$ . There is a unique horizontal vector  $X(z) \in T_z E$  such that  $\text{Exp}_a(X(z)) = n(z)$ . To see that the resulting horizontal vector field  $X$  is smooth, we first observe that changes of  $z$  along the image fiber simply correspond to changes of  $n(z)$  along the fiber  $V(F'_z)$ . As  $z$  moves from image fiber to image fiber, the projected images in  $B$  of the image fibers are the images of the original fibers of  $E$  under the smooth map  $p \circ h$ . The corresponding centers of mass change smoothly, and the remainder of the construction presents no danger of loss of smoothness. Precomposing  $h$  by a fiber-preserving diffeomorphism does not change the image fibers, so  $X(h \text{Diff}_f(E))$  is well-defined. If  $h$  is fiber-preserving, then  $V(F'_z) = F'_z$ ,  $n(z) = z$ , and  $X(h) = Z$ .

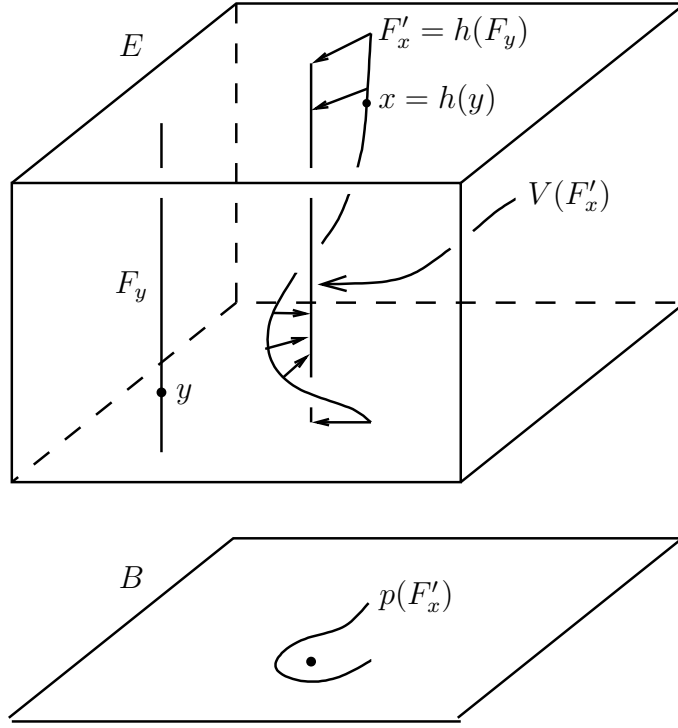

FIGURE 3.2. Canonical straightening of a nearly vertical fiber. The dot in  $B$  is the center of mass of the projection  $p(F'_x)$  of the image fiber  $F'_x$ . The inverse image of the center of mass is the straightened fiber  $V(F'_x)$ , and some of the horizontal vector field  $X$  is shown.

For each image fibering  $h \text{Diff}_f(E)$  in some  $C^\infty$ -neighborhood  $U \text{Diff}_f(E)$  of  $1_E \text{Diff}_f(E)$ , we have defined a horizontal vector field  $X(h \text{Diff}_f(E))$ , for which applying the tame aligned exponential defines a smooth map  $g_{h \text{Diff}_f(E)}$  that moves each image fiber onto a vertical fiber. Since the coset  $1_E \text{Diff}_f(E)$  determines the zero vector field,  $g_{\text{Diff}_f(E)} = 1_E$ . So by reducing the size of  $U$ , if necessary, each  $g_{h \text{Diff}_f(E)}$  will be a diffeomorphism. A local  $\text{Diff}(E)$  cross-section  $\chi: U \text{Diff}_f(E) \rightarrow \text{Diff}(E)$  is then defined by sending  $h \text{Diff}_f(E)$  to  $g_{h \text{Diff}_f(E)}^{-1}$ .

The aligned exponential has analogous local diffeomorphism properties to the ordinary exponential, so we may use it to define a local chart for the Fréchet manifold structure on  $\text{Diff}(E)$  at  $1_E$ , say  $\text{TExp}_a: V \rightarrow \text{Diff}(E)$ , where  $V$  is a neighborhood of  $Z$  in  $\mathcal{X}(E, TE)$ . Our cross-section  $\chi: U \text{Diff}_f(E) \rightarrow \text{Diff}(E)$  takes  $\text{Diff}_f(E)$  to  $1_E$ , so by choosing



$U$  small enough, we may assume that  $\chi$  has image in  $V$ . The local cross-section shows that every fibering contained in  $U \text{Diff}_f(E)$  is the image of the vertical fibering under a diffeomorphism  $\chi(U \text{Diff}_f(E))$  in  $V$ . For  $X$  near  $Z$ , at least,  $\text{TExp}_a(X) \in \text{Diff}_f(E)$  if and only if  $X \in \mathcal{A}(E, TE)$ , so the chart on  $V$  descends to a chart for  $\text{Diff}(E)/\text{Diff}_f(E)$ , defined on a neighborhood of  $Z$  in  $\mathcal{X}(E, TE)/\mathcal{A}(E, TE)$ .

For the Fréchet space structure on  $\mathcal{X}(E, TE)/\mathcal{A}(E, TE)$ , recall that the sections of a vector bundle over a smooth manifold form a Fréchet space [20, Example 1.1.5], and that a closed subspace or quotient by a closed subspace of a Fréchet space is a Fréchet space [20, Section 1.2]. As  $\mathcal{X}(E, TE)$  is a closed subspace of the space of all sections of  $TE$ , it is Fréchet. Since  $\mathcal{A}(E, TE)$  is a closed subspace,  $\mathcal{X}(E, TE)/\mathcal{A}(E, TE)$  is Fréchet as well.

In the case of a very good singular fibering  $p: \Sigma \rightarrow \mathcal{O}$ , we carry out the previous construction working equivariantly in the bundle  $\tilde{\Sigma} \rightarrow \tilde{\mathcal{O}}$ , which may be chosen with  $\tilde{\Sigma}$  compact. Since we are using a  $G$ -equivariant Riemannian metric on  $\tilde{\Sigma}$  and an  $H$ -equivariant one on  $\tilde{\mathcal{O}}$ , and  $\tilde{p}$  is equivariant, all parts of the construction proceed equivariantly. Because  $\tilde{\Sigma}$  is compact, the image fibers of a  $G$ -equivariant diffeomorphism of  $\tilde{\Sigma}$  will project under  $\tilde{p}$  to compact sets, which are small when the fibers are nearly vertical, and consequently the centers of mass will still be well-defined.  $\square$

### 3.8. Restricting to the boundary or the basepoint

Our restriction theorems deal with the case when the suborbifold is properly embedded. By a simple doubling trick, we can also extend to restriction to suborbifolds of the boundary.

**PROPOSITION 3.8.1.** *Let  $\Sigma \rightarrow \mathcal{O}$  be a singular fibering. Let  $S$  be a suborbifold of  $\partial \mathcal{O}$ , and let  $T = p^{-1}(S)$ . Then*

- (a)  $\text{Emb}(S, \partial \mathcal{O})$  admits local  $\text{Diff}(\mathcal{O})$  cross-sections.
- (b)  $\text{Emb}_f(T, \partial_v \Sigma)$  admits local  $\text{Diff}_f(\Sigma)$  cross-sections.

**PROOF.** We first show that  $\text{Diff}(\partial \mathcal{O})$  admits local  $\text{Diff}(\mathcal{O})$  cross-sections. Let  $\Delta$  be the double of  $\mathcal{O}$  along  $\partial \mathcal{O}$ , and regard  $\mathcal{O}$  as a suborbifold of  $\Delta$  by identifying it with one of the two copies of  $\mathcal{O}$  in  $\Delta$ . By Theorem 3.5.12,  $\text{Emb}(\partial \mathcal{O}, \Delta)$  admits local  $\text{Diff}(\Delta)$  cross-sections. We may regard  $\text{Diff}(\partial \mathcal{O})$  as a subspace of  $\text{Emb}(\partial \mathcal{O}, \Delta)$ . Suppose that  $\chi: U \rightarrow \text{Diff}(\Delta)$  is a local cross-section at a point in  $\text{Emb}(\partial \mathcal{O}, \Delta)$  that lies in  $\text{Diff}(\partial \mathcal{O})$ . Elements of  $\text{Diff}(\Delta, \partial \mathcal{O})$  that interchange the sides of  $\mathcal{O}$  are far from elements that preserve the sides, so by making  $U$

smaller if necessary, we may assume that all elements  $f \in U$  such that  $\chi(f)$  lies in  $\text{Diff}(\Delta, \mathcal{O})$  either preserve the sides of  $\mathcal{O}$  or interchange them. In the latter case, we postcompose  $\chi$  with the diffeomorphism of  $\Delta$  that interchanges the two copies of  $\mathcal{O}$ , to assume that all such elements preserve the sides. Then, sending  $g$  to  $\chi(g)|_{\mathcal{O}}$  defines a local  $\text{Diff}(\mathcal{O})$  cross-section on  $U \cap \text{Diff}(\partial \mathcal{O})$ .

By Proposition 3.1.4, for (a) it suffices to produce local cross-sections at the inclusion  $i_S$ . By Theorem 3.5.12, there is a local  $\text{Diff}(\partial \mathcal{O})$  cross-section  $\chi_1$  for  $\text{Emb}(S, \partial \mathcal{O})$  at  $i_S$ . Let  $\chi_2$  be a local  $\text{Diff}(\mathcal{O})$  cross-section for  $\text{Diff}(\partial \mathcal{O})$  at  $\chi_1(i_S)$ . On a neighborhood  $U$  of  $i_S$  in  $\text{Emb}(S, \partial \mathcal{O})$  small enough so that  $\chi_2 \chi_1$  is defined, the composition is the desired  $\text{Diff}(\mathcal{O})$  cross-section. For if  $j \in U$ , then  $\chi_2(\chi_1(j)) \circ i_S = \chi_2(\chi_1(j)) \circ \chi_1(i_S) \circ i_S = \chi_1(j) \circ i_S = j$ .

The proof of (b) is similar. Double  $\Sigma$  along  $\partial_v \Sigma$  and apply Theorem 3.6.7, obtaining local  $\text{Diff}_f(\Sigma)$  cross-sections for  $\text{Diff}_f(\partial_v \Sigma)$ . Apply it again to produce local  $\text{Diff}_f(\partial_v \Sigma)$  cross-sections for  $\text{Emb}_f(T, \partial_v \Sigma)$ . Their composition, where defined, is a local  $\text{Diff}_f(\Sigma)$  cross-section for  $\text{Emb}_f(T, \partial_v \Sigma)$ .  $\square$

An immediate consequence is

**COROLLARY 3.8.2.** *For a singular fibering  $\Sigma \rightarrow \mathcal{O}$ , let  $S$  be a suborbifold of  $\partial \mathcal{O}$ , and let  $T = p^{-1}(S)$ . Then  $\text{Diff}(\mathcal{O}) \rightarrow \text{Emb}(S, \partial \mathcal{O})$  and  $\text{Diff}_f(\Sigma) \rightarrow \text{Emb}_f(T, \partial_v \Sigma)$  are locally trivial. In particular,  $\text{Diff}(\mathcal{O}) \rightarrow \text{Diff}(\partial \mathcal{O})$  and  $\text{Diff}_f(\Sigma) \rightarrow \text{Diff}_f(\partial_v \Sigma)$  are locally trivial.*

Another consequence is

**COROLLARY 3.8.3.** *Let  $\mathcal{W}$  be a suborbifold of  $\mathcal{O}$ . Then the restriction  $\text{Emb}(\mathcal{W}, \mathcal{O}) \rightarrow \text{Emb}(\mathcal{W} \cap \partial \mathcal{O}, \partial \mathcal{O})$  is locally trivial.*

**PROOF.** By Theorem 3.5.12,  $\text{Emb}(\mathcal{W} \cap \partial \mathcal{O}, \partial \mathcal{O})$  admits local  $\text{Diff}(\partial \mathcal{O})$  cross-sections, and by Proposition 3.8.1,  $\text{Diff}(\partial \mathcal{O})$  admits local  $\text{Diff}(\mathcal{O})$  cross-sections. Composing them gives local  $\text{Diff}(\mathcal{O})$  cross-sections for  $\text{Emb}(\mathcal{W} \cap \partial \mathcal{O}, \partial \mathcal{O})$ .  $\square$

**COROLLARY 3.8.4.** *Let  $W$  be a vertical suborbifold of  $\Sigma$ . Then the restriction  $\text{Emb}_f(W, \Sigma) \rightarrow \text{Emb}_f(W \cap \partial_v \Sigma, \partial_v \Sigma)$  is locally trivial.*

**PROOF.** The map is  $\text{Diff}_f(\Sigma)$ -equivariant, and Proposition 3.8.1(b) shows that  $\text{Emb}_f(W \cap \partial_v \Sigma, \partial_v \Sigma)$  admits local  $\text{Diff}_f(\Sigma)$  cross-sections.  $\square$

Some applications of the fibration  $\text{Diff}(M) \rightarrow \text{Emb}(V, M)$  concern the case when the submanifold is a single point. Since in the fibered case a single point is not usually a vertical submanifold, this case is not

directly covered by our previous theorems. The next proposition allows nonvertical suborbifolds that are contained in a single fiber, so applies when the submanifold is a single point. To set notation, let  $p: \Sigma \rightarrow \mathcal{O}$  be a singular fibering. Let  $P$  be a (properly-imbedded) suborbifold of  $\Sigma$  which is contained in a single fiber  $F$ . Let  $T$  be a fibered closed subset of  $\partial_v \Sigma$  which does not meet  $F$ . By  $\text{Emb}_t(P, \Sigma - T)$  we denote the orbifold embeddings whose image is contained in a single fiber of  $\Sigma - T$ , and which extend to elements of  $\text{Diff}_f(\Sigma \text{ rel } T)$ .

**PROPOSITION 3.8.5.** *Let  $P$  be a suborbifold of  $\Sigma$  which is contained in a single fiber  $F$ . Let  $T$  be a fibered closed subset of  $\partial_v \Sigma$ , which does not meet  $F$ . Then  $\text{Emb}_t(P, \Sigma - T)$  admits local  $\text{Diff}_f(\Sigma \text{ rel } T)$  cross-sections.*

**PROOF.** Let  $S = p(T)$ . Notice that  $p(P)$  is a point and is a properly embedded suborbifold of  $\mathcal{O}$ , with orbifold structure determined by the local group at  $p(P)$ . Each embedding  $i \in \text{Emb}_t(P, \Sigma)$  induces an orbifold embedding  $\bar{i}: p(P) \rightarrow \mathcal{O} - S$ .

By Proposition 3.1.4, it suffices to produce a local cross-section at the inclusion  $i_P$ . By Theorem 3.5.12,  $\text{Emb}(p(P), \mathcal{O} - S)$  has local  $\text{Diff}(\mathcal{O} \text{ rel } S)$  cross-sections, and by Proposition 3.6.3,  $\text{Diff}(\mathcal{O} \text{ rel } S)$  has local  $\text{Diff}_f(\Sigma \text{ rel } T)$  cross-sections. A suitable composition of these gives a local  $\text{Diff}_f(\Sigma \text{ rel } T)$  cross-section  $\chi_1$  for  $\text{Emb}(p(P), \mathcal{O} - S)$  at  $\bar{i}_P$ . As remarked in Section 3.1, we may assume that  $\chi_1(\bar{i}_P)$  is the identity diffeomorphism of  $\Sigma$ . By Corollary 3.5.13, there exists a local  $\text{Diff}(F)$  cross-section  $\chi_2$  for  $\text{Emb}(P, F)$  at  $i_P$ , and we may assume that  $\chi_2(i_P)$  is the identity diffeomorphism of  $F$ . Let  $\chi_3$  be a local  $\text{Diff}_f(\Sigma \text{ rel } T)$  cross-section for  $\text{Emb}_f(F, \Sigma - T)$  at  $i_F$  given by Corollary 3.6.8. Regarding  $\text{Diff}(F)$  as a subspace of  $\text{Emb}_f(F, \Sigma - T)$ , we may assume that the composition  $\chi_3 \chi_2$  is defined. On a sufficiently small neighborhood of  $i_P$  in  $\text{Emb}_t(P, \Sigma - T)$  define  $\chi(j) \in \text{Diff}_f(\Sigma \text{ rel } T)$  by

$$\chi(j) = \chi_1(p(j)) (\chi_3 \chi_2) (\chi_1(p(j))^{-1} \circ j) .$$

Then for  $x \in P$  we have

$$\begin{aligned} \chi(j) \circ i_P(x) &= \chi_1(p(j)) (\chi_3 \chi_2) (\chi_1(p(j))^{-1} \circ j) \circ i_P(x) \\ &= \chi_1(p(j)) \chi_1(p(j))^{-1} \circ j(x) \\ &= j(x) \end{aligned}$$

□

This yields immediately

**COROLLARY 3.8.6.** *Let  $W$  be a vertical suborbifold of  $\Sigma$  containing  $P$ . Then  $\text{Diff}_f(\Sigma \text{ rel } T) \rightarrow \text{Emb}_t(P, \Sigma - T)$  and  $\text{Emb}_f(W, \Sigma \text{ rel } T) \rightarrow \text{Emb}_t(P, \Sigma - T)$  are locally trivial.*

### 3.9. The space of Seifert fiberings of a Haken 3-manifold

Let  $p: \Sigma \rightarrow \mathcal{O}$  be a Seifert fibering of a Haken manifold  $\Sigma$ . As noted in Section 3.6,  $p$  is a singular fibering. Denote by  $\text{diff}_f(\Sigma)$  the connected component of the identity in  $\text{Diff}_f(\Sigma)$ , and similarly for other spaces of diffeomorphisms and embeddings. The main result of this section is the following.

**THEOREM 3.9.1.** *Let  $\Sigma$  be a Haken Seifert-fibered 3-manifold. Then the inclusion  $\text{diff}_f(\Sigma) \rightarrow \text{diff}(\Sigma)$  is a homotopy equivalence.*

Before proving Theorem 3.9.1, we will derive some consequences. Each element of  $\text{Diff}(\Sigma)$  carries the given fibering to an isomorphic fibering, and  $\text{Diff}_f(\Sigma)$  is precisely the stabilizer of the given fibering under this action. Following Definition 3.7.1, we define the *space of Seifert fiberings* isomorphic to the given fibering to be the space of cosets  $\text{Diff}(\Sigma)/\text{Diff}_f(\Sigma)$ . Since  $\Sigma$  is not a lens space with one or two exceptional fibers,  $\Sigma$  is a singular fibering. Moreover, every Seifert fibering other than the exceptional lens space ones is finitely covered by an  $S^1$ -bundle (because apart from these cases, the quotient orbifold has a finite orbifold covering by a manifold), so is a very good singular fibering. So Theorem 3.7.3 ensures that the space of Seifert fiberings isomorphic to the given one is a separable Fréchet manifold, and the map

$$\text{Diff}(\Sigma) \rightarrow \text{Diff}(\Sigma)/\text{Diff}_f(\Sigma)$$

is a fibration. Note that since  $\text{Diff}(\Sigma)/\text{Diff}_f(\Sigma)$  is a Fréchet manifold, each connected component is a path component, and since  $\text{Diff}(\Sigma)$  acts transitively on  $\text{Diff}(\Sigma)/\text{Diff}_f(\Sigma)$ , any two components are homeomorphic.

**THEOREM 3.9.2.** *Let  $\Sigma$  be a Seifert-fibered Haken 3-manifold. Then each component of the space of Seifert fiberings of  $\Sigma$  is contractible.*

**PROOF.** As sketched on p. 85 of [71], two fiber-preserving diffeomorphisms of  $\Sigma$  that are isotopic are isotopic through fiber-preserving diffeomorphisms. That is,  $\text{Diff}_f(\Sigma) \cap \text{diff}(\Sigma) = \text{diff}_f(\Sigma)$ . Therefore the connected component of the identity in  $\text{Diff}(\Sigma)/\text{Diff}_f(\Sigma)$  is  $\text{diff}(\Sigma)/(\text{Diff}_f(\Sigma) \cap \text{diff}(\Sigma)) = \text{diff}(\Sigma)/\text{diff}_f(\Sigma)$ . Using Theorem 3.9.1, the latter is contractible.  $\square$

Theorem 3.9.2 shows that the space of Seifert fiberings of  $\Sigma$  is contractible when  $\text{Diff}_f(\Sigma) \rightarrow \text{Diff}(\Sigma)$  is surjective, that is, when every self-diffeomorphism of  $\Sigma$  is isotopic to a fiber-preserving diffeomorphism. Almost all Haken Seifert-fibered 3-manifolds have this property. The closed case is due to F. Waldhausen [69] (see also [49, Theorem 8.1.7]), who showed that (among Haken manifolds) it fails only for the 3-torus, the double of the orientable I-bundle over the Klein bottle, and the *Hantsche-Wendt* manifold, which is the manifold given by the Seifert invariants  $\{-1; (n_2, 1); (2, 1), (2, 1)\}$  (see [49, pp. 133, 138], [12, pp. 478-481], [69], [21]). Topologically, the Hantsche-Wendt manifold is obtained by taking two copies of the orientable I-bundle over the Klein bottle, one with the meridional fibering (the nonsingular fibering as an  $S^1$ -bundle over the Möbius band) and one with the longitudinal fibering (over the disk with two exceptional orbits of type  $(2, 1)$ ) and gluing them together preserving the fibers on the boundary. It admits a diffeomorphism interchanging the two halves, which is not isotopic to a fiber-preserving diffeomorphism. For the bounded case, only  $S^1$ -bundles over the disk, annulus or Möbius band fail to have the property. This appears as Theorem VI.18 of W. Jaco [37]. We conclude:

**THEOREM 3.9.3.** *Let  $\Sigma$  be a Seifert-fibered Haken 3-manifold other than the Hantsche-Wendt manifold, the 3-torus, the double of the orientable I-bundle over the Klein bottle, or an  $S^1$ -bundle over the disk, annulus or Möbius band. Then  $\text{Diff}_f(\Sigma) \rightarrow \text{Diff}(\Sigma)$  is a homotopy equivalence, that is, the space of Seifert fiberings of  $\Sigma$  is contractible.*

The remainder of this section will constitute the proof of Theorem 3.9.1.

**LEMMA 3.9.4.** *Let  $\Sigma$  be a Seifert-fibered Haken 3-manifold, and let  $C$  be a fiber of  $\Sigma$ . Then each component of  $\text{Diff}_v(\Sigma \text{ rel } C)$  is contractible.*

**PROOF.** Since  $\Sigma$  is Haken, the base orbifold of  $\Sigma - C$  has negative Euler characteristic and is not closed. It follows (see [60]) that  $\Sigma - C$  admits an  $\mathbb{H}^2 \times \mathbb{R}$  geometry. Thus there is an action of  $\pi_1(\Sigma - C)$  on  $\mathbb{H}^2 \times \mathbb{R}$  such that every element preserves the  $\mathbb{R}$ -fibers and acts as an isometry in the  $\mathbb{H}^2$ -coordinate.

It suffices to show that  $\text{diff}_v(\Sigma \text{ rel } C)$  is contractible. Let  $N$  be a fibered solid torus neighborhood of  $C$  in  $\Sigma$ . It is not difficult to see (as in the argument below) that  $\text{diff}_v(\Sigma \text{ rel } C)$  deformation retracts to  $\text{diff}_v(\Sigma \text{ rel } N)$ , which can be identified with  $\text{diff}_v(\Sigma - C \text{ rel } N - C)$ , so it suffices to show that the latter is contractible. For  $f \in \text{diff}_v(\Sigma - C \text{ rel } N - C)$ , let  $F$  be a lift of  $f$  to  $\mathbb{H}^2 \times \mathbb{R}$  that has the form  $F(x, s) = (x, s + F_2(x, s))$ , where  $F_2(x, s) \in \mathbb{R}$ .

Since  $f$  is vertically isotopic to the identity relative to  $N - C$ , we may moreover choose  $F$  so that  $F_2(x, s) = 0$  if  $(x, s)$  projects to  $N - C$ . To see this, we choose the lift  $F$  to fix a point in the inverse image  $W$  of  $N - C$ . Since  $f$  is homotopic to the identity relative to  $N - C$ ,  $F$  is equivariantly homotopic to a covering translation relative to  $W$ . That covering translation fixes the point in  $W$ , and therefore must be the identity. Thus  $F$  fixes  $W$  and commutes with every covering translation.

Define  $K_t$  by  $K_t(x, s) = (x, s + (1 - t)F_2(x, s))$ . Since  $K_0 = F$  and  $K_1$  is the identity, and each  $K_t$  is the identity on the inverse image of  $N - C$ , this will define a contraction of  $\text{Diff}_v(\Sigma - C \text{ rel } N - C)$  once we have shown that each  $K_t$  is equivariant. Let  $\gamma \in \pi_1(\Sigma - C)$ . From [60],  $\text{Isom}(\mathbb{H}^2 \times \mathbb{R}) = \text{Isom}(\mathbb{H}^2) \times \text{Isom}(\mathbb{R})$ , so we can write  $\gamma(x, s) = (\gamma_1(x), \epsilon_\gamma s + \gamma_2)$ , where  $\epsilon_\gamma = \pm 1$  and  $\gamma_2 \in \mathbb{R}$ . Since  $F\gamma = \gamma F$ , a straightforward calculation shows that

$$F_2(\gamma_1(x), \epsilon_\gamma s + \gamma_2) = \epsilon_\gamma F_2(x, s) .$$

Now we calculate

$$\begin{aligned} K_t\gamma(x, s) &= K_t(\gamma_1(x), \epsilon_\gamma s + \gamma_2) \\ &= (\gamma_1(x), \epsilon_\gamma s + \gamma_2 + (1 - t)F_2(\gamma_1(x), \epsilon_\gamma s + \gamma_2)) \\ &= (\gamma_1(x), \epsilon_\gamma s + \gamma_2 + (1 - t)\epsilon_\gamma F_2(x, s)) \\ &= (\gamma_1(x), \epsilon_\gamma(s + (1 - t)F_2(x, s)) + \gamma_2) \\ &= \gamma(x, s + (1 - t)F_2(x, s)) \\ &= \gamma K_t(x, s) \end{aligned}$$

showing that  $K_t$  is equivariant. □

**PROOF OF THEOREM 3.9.1.** We first examine  $\text{diff}_v(\Sigma)$ . Choose a regular fiber  $C$  and consider the restriction  $\text{diff}_v(\Sigma) \rightarrow \text{emb}_v(C, \Sigma) \cong \text{diff}(C) \cong \text{diff}(S^1) \simeq \text{SO}(2)$ . By Corollary 3.6.8(ii), this is a fibration. By Lemma 3.9.4, each component of the fiber  $\text{Diff}_v(\Sigma \text{ rel } C) \cap \text{diff}_v(\Sigma)$  is contractible. It follows by the exact sequence for this fibration that  $\pi_q(\text{diff}_v(\Sigma)) \cong \pi_q(\text{SO}(2)) = 0$  for  $q \geq 2$ , and for  $q = 1$  we have an exact sequence

$$0 \longrightarrow \pi_1(\text{diff}_v(\Sigma)) \longrightarrow \pi_1(\text{diff}(C)) \longrightarrow \pi_0(\text{Diff}_v(\Sigma \text{ rel } C) \cap \text{diff}_v(\Sigma)) \longrightarrow 0 .$$

We will first show that exactly one of the following holds.

- a)  $C$  is central and  $\pi_1(\text{diff}_v(\Sigma)) \cong \mathbb{Z}$  generated by the vertical  $S^1$ -action.
- b)  $C$  is not central and  $\pi_1(\text{diff}_v(\Sigma))$  is trivial.

Suppose first that the fiber  $C$  is central in  $\pi_1(\Sigma)$ . Then there is a vertical  $S^1$ -action on  $\Sigma$  which moves the basepoint (in  $C$ ) once around  $C$ . This maps onto the generator of  $\pi_1(\text{diff}(C))$ , so  $\pi_1(\text{diff}_v(\Sigma)) \rightarrow \pi_1(\text{diff}(C))$  is an isomorphism. Therefore  $\pi_1(\text{diff}_v(\Sigma))$  is infinite cyclic, with generator represented by the vertical  $S^1$ -action.

If the fiber is not central, then  $\pi_1(\text{diff}(C)) \rightarrow \pi_0(\text{Diff}(\Sigma \text{ rel } C) \cap \text{diff}_v(\Sigma))$  carries the generator to a diffeomorphism of  $\Sigma$  which induces an inner automorphism of infinite order on  $\pi_1(\Sigma, x_0)$ , where  $x_0$  is a basepoint in  $C$ . Since elements of  $\text{Diff}(\Sigma \text{ rel } C)$  fix the basepoint, this diffeomorphism (and its powers) are not in  $\text{diff}(\Sigma \text{ rel } C)$ . Therefore  $\pi_1(\text{diff}(C)) \rightarrow \pi_0(\text{Diff}(\Sigma \text{ rel } C) \cap \text{diff}_v(\Sigma))$  is injective, so  $\pi_1(\text{diff}_v(\Sigma))$  is trivial.

Now let  $\mathcal{O}$  be the quotient orbifold, and consider the fibration of Theorem 3.6.4:

$$(*) \quad \text{Diff}_v(\Sigma) \cap \text{diff}_f(\Sigma) \longrightarrow \text{diff}_f(\Sigma) \longrightarrow \text{diff}(\mathcal{O}) .$$

Observe that  $\text{diff}(\mathcal{O})$  is homotopy equivalent to the identity component of the space of diffeomorphisms of the 2-manifold  $\mathcal{O} - \mathcal{E}$ , where  $\mathcal{E}$  is the exceptional set. Since  $\Sigma$  is Haken, this 2-manifold is either a torus, annulus, disc with one puncture, Möbius band, or Klein bottle, or a surface of negative Euler characteristic. Therefore  $\text{diff}(\mathcal{O})$  is contractible unless  $\chi(\mathcal{O} - \mathcal{E}) = 0$ , in which case  $\mathcal{E}$  is empty and  $\mathcal{O}$  is an annulus or torus. Thus the higher homotopy groups of  $\text{diff}(\mathcal{O})$  are all trivial, and its fundamental group is isomorphic to the center of  $\pi_1(\mathcal{O})$ . When this center is nontrivial, the elements of  $\pi_1(\mathcal{O})$  are classified by their traces at a basepoint of  $\mathcal{O}$ . From the exact sequence for the fibration  $(*)$ , it follows that  $\pi_q(\text{diff}_f(\Sigma)) = 0$  for  $q \geq 2$ .

To complete the proof, we recall the result of Hatcher [22] and Ivanov [33]: for  $M$  Haken,  $\pi_q(\text{diff}(M))$  is 0 for  $q \geq 2$  and is isomorphic to the center of  $\pi_1(M)$  for  $q = 1$ , and the elements of  $\pi_1(\text{diff}(M))$  are classified by their traces at the basepoint. We already have  $\pi_q(\text{diff}_f(\Sigma)) = 0$  for  $q \geq 2$ , so it remains to show that  $\pi_1(\text{diff}_f(\Sigma)) \rightarrow \pi_1(\text{diff}(\Sigma))$  is an isomorphism.

*Case I:*  $\pi_1(\mathcal{O})$  is centerless.

In this case  $\text{diff}(\mathcal{O})$  is contractible, and either  $C$  generates the center or  $\pi_1(\Sigma)$  is centerless. The exact sequence associated to the fibration  $(*)$  shows that  $\pi_1(\text{diff}_v(\Sigma)) = \pi_1(\text{Diff}_v(\Sigma) \cap \text{diff}_f(\Sigma)) \rightarrow \pi_1(\text{diff}_f(\Sigma))$  is an isomorphism. Suppose  $C$  generates the center. Since  $\pi_1(\text{diff}_v(\Sigma))$  is infinite cyclic generated by the vertical  $S^1$ -action, Hatcher's theorem shows that the composition

$$\pi_1(\text{diff}_v(\Sigma)) \rightarrow \pi_1(\text{diff}_f(\Sigma)) \rightarrow \pi_1(\text{diff}(\Sigma))$$

is an isomorphism. Therefore  $\pi_1(\text{diff}_f(\Sigma)) \rightarrow \pi_1(\text{diff}(\Sigma))$  is an isomorphism. If  $\pi_1(\Sigma)$  is centerless, then  $\pi_1(\text{diff}(\Sigma)) = 0$ ,  $\pi_1(\text{diff}_f(\Sigma)) \cong \pi_1(\text{diff}_v(\Sigma)) = 0$ , and again  $\pi_1(\text{diff}_f(\Sigma)) \rightarrow \pi_1(\text{diff}(\Sigma))$  is an isomorphism.

*Case II:*  $\pi_1(\mathcal{O})$  has center.

Assume first that  $\mathcal{O}$  is a torus. If  $\Sigma$  is the 3-torus, then by considering the exact sequence for the fibration  $(*)$ , one can check directly that the homomorphism  $\partial: \pi_1(\text{diff}(\mathcal{O})) \rightarrow \pi_0(\text{Diff}_v(\Sigma) \cap \text{diff}_f(\Sigma))$  is the zero map. We obtain the exact sequence

$$0 \longrightarrow \mathbb{Z} \longrightarrow \pi_1(\text{diff}_f(\Sigma)) \longrightarrow \mathbb{Z} \times \mathbb{Z} \longrightarrow 0 .$$

Since  $\text{diff}_f(\Sigma)$  is a topological group,  $\pi_1(\text{diff}_f(\Sigma))$  is abelian and hence isomorphic to  $\mathbb{Z} \times \mathbb{Z} \times \mathbb{Z}$ . The traces of the generating elements generate the center of  $\pi_1(\Sigma)$ , which shows that  $\pi_1(\text{diff}_f(\Sigma)) \rightarrow \pi_1(\text{diff}(\Sigma))$  is an isomorphism.

Suppose that  $\Sigma$  is not a 3-torus. Then  $\Sigma$  is a nontrivial  $S^1$ -bundle over  $\mathcal{O}$ ,  $\pi_1(\Sigma) = \langle a, b, t \mid tat^{-1} = a, [a, b] = 1, tbt^{-1} = a^n b \rangle$  for some integer  $n$ , and the fiber  $a$  generates the center of  $\pi_1(\Sigma)$ .

Let  $b_0$  and  $t_0$  be the image of the generators of  $b$  and  $t$  respectively in  $\pi_1(\mathcal{O})$ . Now  $\pi_1(\text{diff}(\mathcal{O})) \cong \mathbb{Z} \times \mathbb{Z}$  generated by elements whose traces represent the elements  $b_0$  and  $t_0$ . By lifting these isotopies we see that  $\partial: \pi_1(\text{diff}(\mathcal{O})) \rightarrow \pi_0(\text{diff}_v(\Sigma))$  is injective. Therefore  $\pi_1(\text{diff}_v(\Sigma))$  is isomorphic to  $\pi_1(\text{diff}_f(\Sigma))$ , and the result follows as in case I.

Assume now that  $\mathcal{O}$  is a Klein bottle. The  $\Sigma$  is an  $S^1$ -bundle over  $\mathcal{O}$ ,  $\pi_1(\Sigma) = \langle a, b, t \mid tat^{-1} = a^{-1}, [a, b] = 1, tbt^{-1} = a^{-n}b^{-1} \rangle$  for some integer  $n$ , with fiber  $a$ , and  $\pi_1(\mathcal{O}) = \langle b_0, t_0 \mid t_0 b_0 t_0^{-1} = b_0^{-1} \rangle$ . Now  $\pi_1(\text{diff}(\mathcal{O}))$  is generated by an isotopy whose trace represents the generator of the center of  $\pi_1(\text{diff}(\mathcal{O}))$ , the element  $t_0^2$ . Observe that  $\pi_1(\Sigma)$  has center if and only if  $n = 0$ . If  $n = 0$ , then it follows that  $\partial: \pi_1(\text{diff}(\mathcal{O})) \rightarrow \pi_0(\text{Diff}_v(\Sigma) \cap \text{diff}_f(\Sigma))$  is the zero map. Hence  $\pi_1(\text{diff}_f(\Sigma)) \rightarrow \pi_1(\text{diff}(\Sigma))$  is an isomorphism and the generator of  $\pi_1(\text{diff}_f(\Sigma))$  is represented by an isotopy whose trace represents the element  $t^2$ . By Hatcher's result,  $\pi_1(\text{diff}_f(\Sigma)) \rightarrow \pi_1(\text{diff}(\Sigma))$  is an isomorphism. If  $n \neq 0$ , then  $\partial: \pi_1(\text{diff}(\mathcal{O})) \rightarrow \pi_0(\text{Diff}_v(\Sigma) \cap \text{diff}_f(\Sigma))$  is injective. Since  $\pi_1(\Sigma)$  is centerless,  $\pi_1(\text{Diff}_v(\Sigma) \cap \text{diff}_f(\Sigma)) = 0$ . This implies that  $\pi_1(\text{diff}_f(\Sigma)) = 0$ , and again Hatcher's result applies.

The cases where  $\mathcal{O}$  is an annulus, disc with one puncture, or a Möbius band are similar to those of the torus and Klein bottle.  $\square$



### 3.10. The Parameterized Extension Principle

As a final application of the methods of this section, we present a result which will be used, often without explicit mention, in our later work. For a parameterized family of diffeomorphisms  $F: M \times W \rightarrow M$ , we denote the restriction  $F: M \times \{u\} \rightarrow M$  by  $F_u \in \text{Diff}(M)$ . By a *deformation* of a parameterized family of diffeomorphisms  $F: M \times W \rightarrow M$ , we mean a homotopy from  $F$  to a parameterized family  $G: M \times W \rightarrow M$  of diffeomorphisms when  $F$  and  $G$  are regarded as maps from  $W$  to  $\text{Diff}(M, M)$ .

**THEOREM 3.10.1** (Parameterized Extension Principle). *Let  $M$  and  $W$  be compact smooth manifolds, let  $M_0$  be a submanifold of  $M$ , and let  $U$  be an open subset of  $M$  with  $M_0 \subset U$ . Suppose that  $F: M \times W \rightarrow M$  is a parameterized family of diffeomorphisms of  $M$ . If  $g \in C^\infty((M_0, M_0 \cap \partial M) \times W, (M, \partial M))$  is sufficiently close to  $F|_{M_0 \times W}$ , then there is a deformation  $G$  of  $F$  such that  $G|_{M_0 \times W} = g$ , and  $G = F$  on  $(M - U) \times W$ . By selecting  $g$  sufficiently close to  $F|_{M_0 \times W}$ ,  $G$  may be selected arbitrarily close to  $F$ .*

**PROOF.** We may assume that each  $F_u$  is the identity on  $M$ . Provided that  $g$  is sufficiently close to  $F|_{M_0 \times W}$ , the Logarithm Lemma 3.1.5 gives sections  $X(g_u) \in \mathcal{X}(M_0, TM)$  such that  $\text{Exp}(X(g_u))(x) = g_u(x)$ . Applying the Extension Lemma 3.1.6 gives a continuous linear map  $k: \mathcal{X}(M_0, TM) \rightarrow \mathcal{X}(M, TM)$  with  $k(X)(x) = X(x)$  for  $x \in M_0$ . Finally, the Exponentiation Lemma 3.1.7 shows that for  $g$  in some neighborhood  $U$  of the inclusion family (that is, the parameterized family with each  $g_u$  the inclusion of  $M_0$  into  $M$ ), each  $\text{TExp} \circ k \circ X$  carries  $U$  into parameterized families of diffeomorphisms. By local convexity, after making  $U$  smaller, if necessary, the resulting diffeomorphisms  $G_u$  will be isotopic to the original  $F_u$  by moving along the unique geodesic between  $G_u(x)$  and  $F_u(x)$ , giving the required deformation.  $\square$



## CHAPTER 4

### Elliptic 3-manifolds containing one-sided Klein bottles

In this chapter, we will prove Theorem 1.2.2. Section 4.1 gives a construction of the elliptic 3-manifolds that contain a one-sided geometrically incompressible Klein bottle; they are described as a family of manifolds  $M(m, n)$  that depend on two integer parameters  $m, n \geq 1$ . Section 4.2 is a section-by-section outline of the entire proof, which constitutes the remaining sections of the chapter.

#### 4.1. The manifolds $M(m, n)$

Let  $K_0$  be a Klein bottle, which will later be the special “base” Klein bottle in  $M(m, n)$ , and write  $\pi_1(K_0) = \langle a, b \mid bab^{-1} = a^{-1} \rangle$ . The four isotopy (as well as homotopy) classes of unoriented essential simple closed curves on  $K_0$  are  $b$ ,  $ab$ ,  $a$ , and  $b^2$ , with  $b$  and  $ab$  orientation-reversing and  $a$  and  $b^2$  orientation-preserving.

Let  $P$  be the orientable I-bundle over  $K_0$ . The free abelian group  $\pi_1(\partial P)$  is generated by elements homotopic in  $P$  to  $a$  and  $b^2$ .

Let  $R$  be a solid torus containing a meridional 2-disk with boundary  $C$ , a circle in  $\partial R$ . For a pair  $(m, n)$  of relatively prime integers, the 3-manifold  $M(m, n)$  is formed by identifying  $\partial R$  and  $\partial P$  in such a way that  $C$  is attached along a simple closed curve representing the element  $a^m b^{2n}$ . If  $m = 0$ , the resulting manifold is  $\mathbb{RP}^3 \# \mathbb{RP}^3$ , while if  $n = 0$  it is  $S^2 \times S^1$ . In these cases  $K_0$  is compressible, so from now on we will assume that neither  $m$  nor  $n$  is zero. Since  $M(-m, n) = M(m, n)$  and  $M(-m, -n) = M(m, n)$ , we can and always will assume that both  $m$  and  $n$  are positive.

Each fibering of  $K_0$  extends to a Seifert fibering of  $M(m, n)$ , for which  $P$  and  $R$  are fibered submanifolds. If  $K_0$  has the longitudinal fibering, then in  $\partial P$  the fiber represents  $b^2$ . The meridian circle  $C$  of  $R$  equals  $ma + nb^2$ . Choosing  $p$  and  $q$  so that  $mp - nq = 1$ , the element  $L = qa + pb^2$  is a longitude of  $R$ , since the intersection number  $C \cdot L = mp - nq = 1$ . We find that  $b^2 = mL - qC$ , so on  $R$  the Seifert fibering has an exceptional fiber of order  $m$ , unless  $m = 1$ . If instead  $K_0$  has the meridional fibering, then the fiber represents  $a$  in  $\partial R$ , and

since  $a = pC - nL$ ,  $R$  has an exceptional fiber of order  $n$ , unless  $n = 1$ . In terms of  $m$  and  $n$ , then, the cases discussed in Section 1.2 are as follows: I is  $m > 1$  and  $n > 1$ , II is  $m = 1$  and  $n > 1$ , III is  $m > 1$  and  $n = 1$ , and IV is  $m = n = 1$ .

The fundamental group of  $M(m, n)$  has a presentation

$$\langle a, b \mid bab^{-1} = a^{-1}, a^m b^{2n} = 1 \rangle .$$

Note that  $a^{2m} = 1$  and  $b^{4n} = 1$ .

If  $n$  is odd, then  $\pi_1(M(m, n)) \cong C_n \times D_{4m}^*$ , where  $C_n$  is cyclic and

$$D_{4m}^* = \langle x, y \mid x^2 = y^m = (xy)^2 \rangle$$

is the binary dihedral group. The  $C_n$  factor is generated by  $b^4$  and the  $D_{4m}^*$  factor by  $x = b^n$  and  $y = a$ .

If  $n$  is even, write  $C_{4n} = \langle t \mid t^{4n} = 1 \rangle$ . Let  $\Delta$  be the diagonal subgroup of index 2 in  $C_{4n} \times D_{4m}^*$ . That is, there is a unique homomorphism from  $C_{4n}$  onto  $C_2$ , and, since  $m$  is odd, a unique homomorphism from  $D_{4m}^*$  onto  $C_2$ . The latter sends  $y$  to 1. Combining these homomorphisms sends  $C_{4n} \times D_{4m}^*$  onto  $C_2$  with kernel  $\Delta$ . The element  $(t^{2n}, y^m)$  is a central involution in  $\Delta$ , and  $\pi_1(M(m, n))$  is isomorphic to  $\Delta / \langle (t^{2n}, y^m) \rangle$ . The correspondence is that  $a = (1, y)$  and  $b = (t, x)$ .

When  $m = 1$ , the groups reduce in both cases to a cyclic group of order  $4n$ . From [7] or [56],  $M(1, n) = L(4n, 2n - 1)$ . This homeomorphism can be seen directly as follows. Let  $T$  be a solid torus with  $H_1(\partial T)$  the free abelian group generated by  $\lambda$ , a longitude, and  $\mu$ , the boundary of a meridian disk. Let  $C_1$  and  $C_2$  be disjoint loops in  $\partial T$ , each representing  $2\lambda + \mu$ . There is a Möbius band  $M$  in  $T$  with boundary  $C_2$ . The double of  $T$  is an  $S^2 \times S^1$  in which  $M$  and the other copy of  $M$  form a one-sided Klein bottle. The double has a Seifert fibering which is longitudinal on the Klein bottle, nonsingular on its complement, and in which  $C_1$  is a fiber. If the attaching map in the doubling is changed by Dehn twists about  $C_1$ , the resulting manifolds are of the form  $M(1, n)$ , since they still have fiberings which are longitudinal on the Klein bottle and nonsingular on its complement. Since  $\mu$  intersects  $C_1$  twice, the image of  $\mu$  under  $k$  Dehn twists about  $C_1$  is  $\mu + 2k(\mu + 2\lambda) = 4k\lambda + (2k + 1)\mu$ , so the resulting manifold is  $L(4k, 2k + 1) = L(4k, 2k - 1)$ . It must equal  $M(1, k)$  since  $M(1, k)$  is the only manifold of the form  $M(1, n)$  with fundamental group  $C_{4k}$ .

As we have seen, with the longitudinal fibering the manifolds  $M(m, n)$  have fibers of orders 2, 2, and  $m$ , so in the terminology of [46],  $M(2, n)$  is a quaternionic manifold, while for  $m > 2$ ,  $M(m, n)$  is a (nonquaternionic) prism manifold.

## 4.2. Outline of the proof

By Theorem 1.2.1, the inclusion  $\text{Isom}(M(m, n)) \rightarrow \text{Diff}(M(m, n))$  is a bijection on path components, so we need only prove that the inclusion  $\text{isom}(M(m, n)) \rightarrow \text{diff}(M(m, n))$  of the connected components of the identity induces isomorphisms on all homotopy groups. The rest of this chapter establishes this when at least one of  $m$  or  $n$  is greater than 1, that is, for Cases I, II, and III in Section 1.2. The remaining possibility  $M(1, 1)$  is the lens space  $L(4, 1)$ , for which the Smale Conjecture holds by Theorem 1.2.3 proven in Chapter 5.

In Section 4.3, we give a calculation of the connected components of the identity in the isometry groups of the  $M(m, n)$ , in the process establishing the viewpoint and notation needed in Section 4.4.

The first task in Section 4.4 is to observe that the elements of  $\pi_1(M(m, n))$  preserve the fibers of the Hopf fibering of  $S^3$ . Consequently there is an induced Seifert fibering of the  $M(m, n)$ , which we call the Hopf Seifert fibering of  $M(m, n)$ . A certain torus  $T_0$  in  $S^3$ , vertical in the Hopf fibering, descends to a vertical Klein bottle  $K_0$  in  $M(m, n)$  which we call the base Klein bottle. On  $K_0$ , the Hopf fibering of  $M(m, n)$  restricts to the longitudinal fibering in Cases I and II and the meridional fibering in Case III. In Section 4.4, we also check that the isometries of  $M(m, n)$  are fiber-preserving and act isometrically on the quotient orbifold.

Most of Section 4.4 is devoted to verifying two facts:

- (a) The map from  $\text{isom}(M(m, n))$  to the space of fiber-preserving isometric embeddings of  $K_0$  into  $M(m, n)$ , defined by restriction to  $K_0$ , is a homeomorphism onto the connected component of the inclusion (Lemma 4.4.4).
- (b) The inclusion of the latter space into the space of all fiber-preserving embeddings of  $K_0$  into  $M(m, n)$  that are isotopic to the inclusion is a homotopy equivalence (Lemma 4.4.5).

The big picture of what is going on here can be seen by consideration of the three types of quotient orbifolds shown in table 2, which correspond to Cases I, II, and III respectively. For the first two types,  $K_0$  is the inverse image of a geodesic arc connecting the two order 2 cone points, and for the third type,  $K_0$  is the inverse image of a “great circle” geodesic in  $\mathbb{RP}^2$ . The inverse images of such geodesics are the images of the fiber-preserving isometric embeddings isotopic to the inclusion, the so-called “special” Klein bottles. They are the translates of  $K_0$  under  $\text{isom}(M(m, n))$  (which also contains “vertical” isometries that take each fiber to itself, so preserve each special Klein bottle). Our precise description of  $\text{isom}(M(m, n))$  allows us to examine its effects on these Klein bottles and establish fact (a). For the first two types of

quotient orbifold, a fiber-preserving embedding of  $K_0$  that is isotopic to the inclusion carries  $K_0$  onto the inverse image of an arc connecting two order 2-cone points and isotopic (avoiding the third cone point, if there is one) to a geodesic arc, and for the third type they carry  $K_0$  onto the inverse image of an essential circle in  $\mathbb{RP}^2$ . Fact (b) for the third type of orbifold boils down to the fact that the space of all essential embeddings of the circle in  $\mathbb{RP}^2$  is homotopy equivalent to the space of geodesic embeddings (which is  $L(4, 1)$ ), and analogous properties of arcs in the other two types of orbifolds.

The reader who is comfortable with this summary of Sections 4.3 and 4.4 has little need to wade through their details.

The Smale Conjecture for the  $M(m, n)$  reduces to Theorem 4.5.1, which says that the inclusion of the space of *fiber-preserving* embeddings of  $K_0$  into  $M(m, n)$  into the space of *all* embeddings of  $K_0$  into  $M(m, n)$  is a homotopy equivalence (on the connected components of the inclusion  $K_0 \rightarrow M(m, n)$ ). This is the main content of Section 4.5, and is obtained using the results of Section 4.4 and routine manipulation of exact sequences arising from fibrations of various spaces of mappings.

The final three sections are the proof of Theorem 4.5.1. One must start with a family of embeddings of  $K_0$  into  $M(m, n)$  parameterized by  $D^k$ , and change it by homotopy as an element of  $\text{Maps}(D^k, \text{emb}(K_0, M(m, n)))$  to a family of fiber-preserving embeddings. The embeddings are fiber-preserving at parameters in  $\partial D^k$ , and this property must be retained so during the homotopy. Sections 4.6 and 4.7 are auxiliary results needed for the main argument in Section 4.8.

In Section 4.6, we analyze the situation when an embedded Klein bottle  $K$  meets  $K_0$  in “generic position,” meaning that all tangencies are of finite multiplicity type. In  $M(m, n)$ ,  $K_0$  has a standard neighborhood which is a twisted I-bundle  $P$ , and  $P - K_0$  has a product structure  $T \times (0, 1]$  with each  $T_u = T \times \{u\}$  a fibered “level” torus. The key result of the analysis is Proposition 4.6.2, which says for all  $u$  sufficiently close to 0, each circle of  $K \cap T_u$  is either inessential in  $T_u$ , or represents  $a$  or  $b^2$  in  $\pi_1(T_u)$ . We will see below where this critical fact is needed.

The proof of Proposition 4.6.2 uses a technique which may seem surprising in our differentiable context. Since we may not have full transversality, we go ahead and make the situation much less transverse, by a process called *flattening*. It moves  $K$  to a PL-embedded Klein bottle that intersects  $K_0$  in a 2-complex, but still meets torus levels for  $u$  near 0 in loops isotopic to their original intersection circles

with  $K$ . For these flattened surfaces, combinatorial arguments can be used to establish that those intersection circles are  $a$ - and  $b^2$ -curves. Proposition 4.6.2 fails for  $M(1, 1)$ , as we show by example.

Section 4.7 recalls Ivanov's idea [36] of perturbing a parameterized family of embeddings of  $K_0$  into  $M(m, n)$  so that each image meets  $K_0$  in generic position. A bit of extra work is needed to ensure that during a homotopy from our original family to the generic position family, the embeddings remain fiber-preserving at parameters in  $\partial D^k$ .

Section 4.8 is the argument to make a parameterized family of embeddings  $K_0 \rightarrow K_t \subset M(m, n)$ ,  $t \in D^k$ , fiber-preserving for the Hopf fibering on  $M(m, n)$ . The first step is a minor technical trick needed to ensure that no  $K_t$  equals  $K_0$ ; this allows Section 4.7 to be applied to assume that the  $K_t$  meet  $K_0$  in generic position. Next, we use Hatcher's methods to simplify the intersections of the Klein bottles  $K_t$  with the torus levels  $T_u$ . Each  $K_t$  has finitely many associated torus levels  $T_u$ , obtained using Proposition 4.6.2. First, we eliminate intersections that are contractible in  $K_t$  (and hence in  $T_u$ ). This part of the argument, called Step 2, is a straightforward adaptation of Hatcher's arguments from [23, 25], but we give a fair amount of detail since these methods are not widely used.

Step 3 is where the hard work from Section 4.6 comes into play. From our analysis of generic position configurations, specifically Proposition 4.6.2, we know that  $K_t$  meets its associated levels  $T_u$  in circles that represent  $a$  or  $b^2$  in  $\pi_1(T_u)$ . Now,  $T_u$  separates  $M(m, n)$  into a twisted I-bundle  $P_u$ , containing  $K_0$ , and a solid torus  $R_u$ . Some homological arguments (which again break down for  $M(1, 1)$ ) show that a circle of  $K_t \cap T_u$  is a longitude of  $R_u$  only if it is isotopic in  $T_u$  to a fiber. Hence any circles of  $K_t \cap T_u$  that are *not* isotopic to fibers are also *not longitudes of  $R_u$* , and consequently *the annuli of  $K_t \cap R_u$  that contain them are uniquely boundary-parallel in  $R_u$* . This allows us to once again apply Hatcher's parameterized methods to pull the annuli of  $K_t \cap R_u$  whose boundary circles are not isotopic in  $T_u$  to fibers out of  $R_u$ , achieving that *every loop of  $K_t \cap T_u$  is isotopic in  $T_u$  to a fiber*.

Two tasks remain:

- (1) Make  $K_t$  intersect its associated levels  $T_u$  in circles that are fibers and are the images of fibers of  $K_0$  under the embedding  $K_0 \rightarrow M(m, n)$ .
- (2) Make the embeddings fiber-preserving on the intersections of  $K_t$  with the other pieces of  $M(m, n)$ , which are topologically either twisted I-bundles over  $K_0$ , product regions between levels, or solid tori that are complements of twisted I-bundles over  $K_0$ .

The underlying facts about fiber-preserving embeddings needed for this are given in Step 4. The final part of the argument, Step 5, applies these facts, working up the skeleta of a triangulation of  $D^k$ , to complete the deformation.

### 4.3. Isometries of elliptic 3-manifolds

In Section 1.1, we recalled the isometry groups of elliptic 3-manifolds. We will now present the calculations of these groups—actually, only the connected component  $\text{isom}(M)$  of the identity—for the elliptic 3-manifolds that contain a geometrically incompressible Klein bottle. Besides giving an opportunity to revisit the beautiful interaction between the structure of  $S^3$  as the unit quaternions and the structure of  $\text{SO}(4)$ , which will provide the setting for some key technical results in Section 4.4.

Fix coordinates on  $S^3$  as  $\{(z_0, z_1) \mid z_i \in \mathbb{C}, z_0 \bar{z}_0 + z_1 \bar{z}_1 = 1\}$ . Its group structure as the unit quaternions can then be given by writing points in the form  $z_0 + z_1 j$ , where  $j^2 = -1$  and  $j z_i = \bar{z}_i j$ . The unique element of order 2 in  $S^3$  is  $-1$ , and it generates the center of  $S^3$ .

By  $S^1$  we will denote the subgroup of points in  $S^3$  with  $z_1 = 0$ , that is, all quaternions of the form  $z_0$ , where  $z_0$  lies in the unit circle in  $\mathbb{C}$ . Let  $\xi_k = \exp(2\pi i/k)$ , which generates a cyclic subgroup  $C_k \subset S^1$ . The elements  $S^1 \cup S^1 j$  form a subgroup  $\text{O}(2)^* \subset S^3$ , which is exactly the normalizer of  $C_k$  if  $k > 2$ . Also contained in  $\text{O}(2)^*$  is the binary dihedral group  $D_{4m}^*$  generated by  $x = j$  and  $y = \xi_{2m}$ ; its normalizer is  $D_{8m}^*$ . By  $J$  we denote the subgroup of  $S^3$  consisting of the elements with both  $z_0$  and  $z_1$  real. It is the centralizer of  $j$ .

The real part  $\Re(z_0 + z_1 j)$  is the real part  $\Re(z_0)$  of the complex number  $z_0$ , and the imaginary part  $\Im(z_0 + z_1 j)$  is  $\Im(z_0) + z_1 j$ . The usual inner product on  $S^3$  is given by  $z \cdot w = \Re(z w^{-1})$ , where  $\Re(z_0 + z_1 j) = \Re(z_0)$ . Consequently, left multiplication and right multiplication by elements of  $S^3$  are orthogonal transformations of  $S^3$ , and there is a homomorphism  $F: S^3 \times S^3 \rightarrow \text{SO}(4)$  defined by  $F(q_1, q_2)(q) = q_1 q q_2^{-1}$ . It is surjective and has kernel  $\{(1, 1), (-1, -1)\}$ .

The quaternions with real part 0 are the pure imaginary quaternions, and form a subspace  $P \subset S^3$  homeomorphic to  $S^2$ . In fact,  $P$  is exactly the orthogonal complement of 1. Conjugation by elements of  $S^3$  preserves  $P$ , defining a surjective homomorphism  $S^3 \rightarrow \text{SO}(3)$  with kernel  $\langle \pm 1 \rangle$ .

Suppose that  $G$  is a finite subgroup of  $\text{SO}(4)$  acting freely on  $S^3$ . Since  $\text{SO}(4)$  is the full group of orientation-preserving isometries of  $S^3$ , the orientation-preserving isometries  $\text{Isom}_+(S^3/G)$  are the quotient



$\text{Norm}(G)/G$ , where  $\text{Norm}(G)$  is the normalizer of  $G$  in  $\text{SO}(4)$ . Assuming that the group  $G$  is clear from the context, we denote the isometry that an element  $F(q_1, q_2)$  of  $\text{Norm}(G)$  induces on  $S^3/G$  by  $f(q_1, q_2)$ .

Let  $G^* = F^{-1}(G)$ , and let  $G_L$  and  $G_R$  be the projections of  $G^*$  into the left and right factors of  $S^3 \times S^3$ . Notice that  $\text{Norm}(G)/G \cong \text{Norm}(G^*)/G^*$ . The connected component of the identity in  $\text{Norm}(G^*)$  is denoted by  $\text{norm}(G^*)$ . Since  $G^*$  is discrete, these elements centralize  $G^*$ . Consequently,  $\text{norm}(G^*)$  is the product  $\text{norm}(G_L) \times \text{norm}(G_R)$  of the corresponding connected normalizers of  $G_L$  and  $G_R$  in the  $S^3$  factors. The connected component of the identity in the isometry group of  $S^3/G$  is then  $\text{isom}(M) = \text{norm}(G^*)/(G^* \cap \text{norm}(G^*))$ . We now compute  $\text{isom}(M(m, n))$  for the four cases listed in Section 1.2:

*Case II and IV.  $m = 1$ .*

The element  $F(\xi_{4n}^{n-1}, i)$  acts on  $S^3$  by

$$F(\xi_{4n}^{n-1}, i)(z_0 + z_1j) = \xi_{4n}^{n-1}z_0(-i) + \xi_{4n}^{n-1}z_1j(-i) = \xi_{4n}^{-1}z_0 + \xi_{4n}^{2n-1}z_1j.$$

Consequently the quotient of  $S^3$  by the subgroup generated by  $F(\xi_{4n}^{n-1}, i)$  is  $L(4n, 2n+1) = L(4n, 2n-1) = M(1, n)$ . For some work in Section 4.4, however, it is more convenient to use a conjugate of this generator. Conjugation by  $F(1, \frac{1}{\sqrt{2}}i + \frac{1}{\sqrt{2}}j)$  moves  $F(\xi_{4n}^{n-1}, i)$  to  $F(\xi_{4n}^{n-1}, j)$ . The latter will be our standard generator for  $G = \pi_1(M(1, n))$ .

Letting  $G$  be the group  $C_{4n}$  generated by  $F(\xi_{4n}^{n-1}, j)$ ,  $G_R$  is the cyclic subgroup of order 4 generated by  $j$ , so  $\text{norm}(G_R) = J$ , and  $G_L$  is generated by  $\{\xi_{4n}^{n-1}, -1\}$ . If  $n = 1$ , then  $\xi_{4n}^{n-1} = 1$  and  $G_L = C_2$ . If  $n > 1$  then  $\xi_{4n}^{n-1}$  has order  $4n/\text{gcd}(4n, n-1) = 4n/\text{gcd}(4, n-1)$ , so  $G_L$  is  $C_{4n}$  if  $n$  is even,  $C_{2n}$  if  $n \equiv 3 \pmod{4}$ , and  $C_n$  if  $n \equiv 1 \pmod{4}$ .

- (1) If  $n = 1$ , then  $\text{norm}(G_L) = S^3$ , and  $\text{isom}(M(1, 1)) \cong \text{SO}(3) \times S^1$ , consisting of all isometries of the form  $f(q, x)$  with  $(q, x) \in S^3 \times J$ .
- (2) If  $n > 1$ , then  $\text{norm}(G_L) = S^1$ , so  $\text{isom}(M(1, n)) \cong S^1 \times S^1$ , consisting of all isometries of the form  $f(x_1, x_2)$  with  $(x_1, x_2) \in S^1 \times J$ .

*Case III.  $m > 1$  and  $n = 1$ .*

We embed  $G = D_{4m}^*$  in  $\text{SO}(4)$  as the subgroup  $F(D_{4m}^* \times \{1\})$ . We have  $G_L = D_{4m}^*$  and  $G_R = C_2$ , so  $\text{norm}(G_L) \times \text{norm}(G_R) = \{1\} \times S^3$ . Therefore  $\text{isom}(M(m, 1)) \cong \text{SO}(3)$ , and consists of all isometries of the form  $f(1, q)$ .

*Case I.  $m > 1$  and  $n > 1$ .*

If  $n$  is odd, then  $G = C_n \times D_{4m}^*$ , and we embed  $G$  in  $\text{SO}(4)$  as  $F(C_{2n} \times D_{4m}^*)$ , so  $G_L = C_{2n}$  and  $G_R = D_{4m}^*$ . If  $n$  is even, then  $G$

| $m, n$ values  | $M$  | $\text{isom}(M)$   |
|----------------|--|--|
| $m = n = 1$    | $L(4, 1)$  | $\text{SO}(3) \times S^1 = \{f(q, x) \mid (q, x) \in S^3 \times J\}$ |
| $m = 1, n > 1$ | $L(4n, 2n - 1)$                                  | $S^1 \times S^1 = \{f(x, y) \mid (x, y) \in S^1 \times J\}$          |
| $m > 1, n = 1$ | quaternionic ( $m = 2$ )<br>or prism ( $m > 2$ ) | $\text{SO}(3) = \{f(1, q) \mid q \in S^3\}$                          |
| $m > 1, n > 1$ | quaternionic ( $m = 2$ )<br>or prism ( $m > 2$ ) | $S^1 = \{f(x, 1) \mid x \in S^1\}$                                   |

TABLE 1. Isometry groups of the  $M(m, n)$ 

is the image in  $\text{SO}(4)$  of the unique diagonal subgroup of index 2 in  $C_{4n} \times D_{4m}^*$ , so  $G_L = C_{4n}$  and  $G_R = D_{4m}^*$ . In either case, we have  $\text{norm}(G_L) \times \text{norm}(G_R) = S^1 \times \{1\}$ . Therefore  $\text{isom}(M(m, n)) \cong S^1$ , and consists of all isometries of the form  $f(x, 1)$  with  $x \in S^1$ .

Table 1 summarizes our calculations of  $\text{Isom}(M(m, n))$ .

#### 4.4. The Hopf fibering of $M(m, n)$ and special Klein bottles

From now on, we use  $M$  to denote one of the manifolds  $M(m, n)$  with  $m > 1$  or  $n > 1$ . In this section, we construct certain Seifert fiberings of these  $M$ , which we will call their Hopf fiberings, and examine the effect of  $\text{isom}(M)$  on them. Also, we define certain vertical Klein bottles in  $M$ , called special Klein bottles, are deeply involved in the reductions carried out in Section 4.5. A certain special Klein bottle  $K_0$ , called the base Klein bottle, will play a key role.

We will regard the 2-sphere  $S^2$  as  $\mathbb{C} \cup \{\infty\}$ . We speak of antipodal points and orthogonal transformations on  $S^2$  by transferring them from the unit 2-sphere using the stereographic projection that identifies the point  $(x_1, x_2, x_3)$  with  $(x_1 + x_2i)/(1 - x_3)$ . For example, the antipodal map  $\alpha$  is defined by  $\alpha(z) = -1/\bar{z}$ .

As is well-known, the Hopf fibering on  $S^3$  is an  $S^1$ -bundle structure with projection map  $H: S^3 \rightarrow S^2$  defined by  $H(z_0, z_1) = z_0/z_1$ . The left action of  $S^1$  on  $S^3$  takes each Hopf fiber to itself, so preserves the Hopf fibering. The element  $F(j, 1)$  also preserves it. For  $j(z_0 + z_1j) = -\bar{z}_1 + \bar{z}_0j$ , so  $H(F(j, 1)(z_0 + z_1j)) = -1/\overline{z_0/z_1}$ . Right multiplication by elements of  $S^3$  commutes with the left action of  $S^1$ , so it preserves the Hopf fibering, and there is an induced action of  $S^3$  on  $S^2$ . In fact, it acts orthogonally. For if we write  $x = x_0 + x_1j$  and  $z = z_0 + z_1j$ , we have  $zx^{-1} = z_0\bar{x}_0 + z_1\bar{x}_1 + (z_1x_0 - z_0x_1)j$ , so the induced action on  $S^2$  carries  $z_0/z_1$  to  $(z_0\bar{x}_0 + z_1\bar{x}_1)/(z_1x_0 - z_0x_1) =$

$$\frac{\overline{x}_0 \begin{pmatrix} z_0 \\ z_1 \end{pmatrix} + \overline{x}_1}{-x_1 \begin{pmatrix} z_0 \\ z_1 \end{pmatrix} + x_0} = \begin{pmatrix} \overline{x}_0 & \overline{x}_1 \\ -x_1 & x_0 \end{pmatrix} (z_0/z_1). \quad \text{The trace of this linear frac-}$$

tional transformation is real and lies between  $-2$  and  $2$  (unless  $x = \pm 1$ , which acts as the identity on  $S^2$ ), so it is elliptic. Its fixed points are  $((x_0 - \overline{x}_0) \pm \sqrt{(x_0 - \overline{x}_0)^2 - 4x_1\overline{x}_1})/(2x_1)$ , which are antipodal, so it is an orthogonal transformation. Combining these observations, we see that the action induced on  $S^2$  via  $H$  determines a surjective homomorphism  $h: \mathrm{O}(2)^* \times S^3 \rightarrow \mathrm{O}(3)$ , given by  $h(x_0, 1) = 1$  for  $x_0 \in S^1$ ,  $h(j, 1) = \alpha$ , and  $h(1, x_0 + x_1j) = \begin{pmatrix} \overline{x}_0 & \overline{x}_1 \\ -x_1 & x_0 \end{pmatrix}$ . The kernel of  $h$  is  $S^1 \times \{\pm 1\}$ .

With the explicit embeddings selected in Section 4.3, each of our groups  $G = \pi_1(M)$  lies in  $F(\mathrm{O}(2)^* \times S^3)$ , so preserves the Hopf fibering, and descends to a Seifert fibering on  $M(m, n) = S^3/G$ .

**DEFINITION 4.4.1.** The *Hopf fibering* of  $M(m, n)$  is the image of the Hopf fibering of  $S^3$  under the quotient map  $S^3 \rightarrow S^3/\pi_1(M(m, n))$ . We will always use the Hopf fibering on the manifolds  $M(m, n)$ .

The Hopf fibering  $H: S^3 \rightarrow S^2$  induces the orbit map  $M(m, n) \rightarrow S^2/h(G)$ , and the orbit map is induced by the composition of  $H$  followed by the quotient map from  $S^2$  to the quotient orbifold  $S^2/h(G)$ . The quotient orbifolds for our fiberings are easily calculated using the explicit embeddings of  $G$  into  $\mathrm{SO}(4)$  given in Section 4.3, together with the facts that  $h(j, 1) = \alpha$ ,  $h(1, \xi_{2m}) = r_m$ , the (clockwise) rotation through an angle  $2\pi/m$  with fixed points  $0$  and  $\infty$ , defined by  $r_m(z) = \xi_m^{-1}z$ , and  $h(1, j) = t$ , the rotation through an angle  $\pi$  with fixed points  $\pm i$ , defined by  $t(z) = -1/z$ . Table 2 lists the various cases, where  $(F; n_1, \dots, n_k)$  denotes the 2-orbifold with underlying topological space the surface  $F$  and  $k$  cone points of orders  $n_1, \dots, n_k$ .

Since  $m > 1$  or  $n > 1$ , we have  $\mathrm{norm}(\pi_1(M)) \subset F(\mathrm{O}(2)^* \times S^3)$ , so  $\mathrm{isom}(M)$  preserves the Hopf fibering. Since the quotient orbifolds are the quotients of orthogonal actions on  $S^2$ , they have metrics of constant curvature 1, except at the cone points, where the cone angle at an order  $k$  cone point is  $2\pi/k$ . Table 2 shows the quotient orbifolds with shapes that suggest the symmetries for this constant curvature metric. The isometry group of each orbifold  $\mathcal{O}$  is the normalizer of its orbifold fundamental group  $h(G)$  in the isometry group  $\mathrm{O}(3)$  of  $S^2$ . The homomorphism  $h$  induces a homomorphism  $\mathrm{isom}(M) \rightarrow \mathrm{isom}(\mathcal{O})$ , and from the explicit description of  $\mathrm{isom}(M)$  from Table 1 we can use  $h$  to

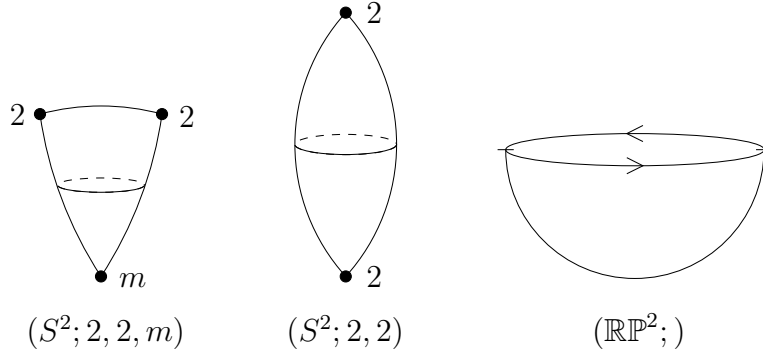

| $m, n$ values  | $h(\pi_1(M))$                     | $\mathcal{O}$       | $\text{isom}(\mathcal{O})$ |
|----------------|-----------------------------------|---------------------|----------------------------|
| $m > 1, n > 1$ | $D_{2m} = \langle r_m, t \rangle$ | $(S^2; 2, 2, m)$    | $\{1\}$                    |
| $m = 1, n > 1$ | $C_2 = \langle t \rangle$         | $(S^2; 2, 2)$       | $\text{SO}(2)$             |
| $m > 1, n = 1$ | $C_2 = \langle \alpha \rangle$    | $(\mathbb{RP}^2; )$ | $\text{SO}(3)$             |

TABLE 2. Quotient orbifolds for the Hopf fiberings

compute the image. In each case, all isometries in the connected component of the identity,  $\text{isom}(\mathcal{O})$ , are induced by elements of  $\text{isom}(M)$ . (The groups  $\text{isom}(\mathcal{O})$  are computed as  $\text{norm}(G)/(G \cap \text{norm}(G))$  where  $\text{norm}(G)$  is the connected component of the identity in the normalizer of  $G$  in  $\text{isom}(S^2) = \text{SO}(3)$ . In particular,  $\text{isom}(\mathbb{RP}^2) = \text{SO}(3)$ , which can be seen directly by noting that each isometry of  $\mathbb{RP}^2$  lifts to a unique orientation-preserving isometry of  $S^2$ .)

Our next task is to understand the fibered Klein bottles in  $M$ .

DEFINITION 4.4.2. A torus  $T \subset S^3$  *special* if its image in  $S^2$  under  $H$  is a great circle. Klein bottles in  $M$  that are the images of special tori in  $S^3$  are called *special Klein bottles*. A suborbifold in  $\mathcal{O}$  is called *special* when it is either

- (i) a one-sided geodesic circle (when  $\mathcal{O} = \mathbb{RP}^2$ ), or
- (ii) a geodesic arc connecting two order-2 cone points (in the other two cases).

Clearly special tori are vertical in the Hopf fibering. We remark that special tori are Clifford tori, that is, they have induced curvature zero in the usual metric on  $S^3$ .

A Klein bottle in  $M$  is special if and only if its image in  $\mathcal{O}$  is a special suborbifold. To see this, consider a special torus  $T$  in  $S^3$ . If its image in  $\mathcal{O}$  is special, then its image in  $M$  is a one-sided submanifold,

so must be a Klein bottle. Conversely, the projection of  $T$  to  $\mathcal{O}$  must always be a geodesic, and if its image in  $M$  is a submanifold, then the projection to  $\mathcal{O}$  cannot have any self intersections or meet a cone point of order more than 2. And if the projection is a circle, it is one-sided if and only if the image of  $T$  in  $M$  is one-sided.

Note that the fibering on a special Klein bottle is meridional (i. e. an  $S^1$ -bundle over  $S^1$ ) in case (i), and longitudinal (two exceptional fibers that are center circles of Möbius bands) in case (ii). From Table 2, we see that:

- (1) When  $n = 1$ , special Klein bottles have the meridional fibering.
- (2) When  $n > 1$ , special Klein bottles have the longitudinal fibering.

Let  $T_0$  be the fibered torus  $H^{-1}(U)$ , where  $U$  is the unit circle in  $S^2$ . Explicitly,  $T_0$  consists of all  $z_0 + z_1 j$  for which  $|z_0| = |z_1| = \frac{1}{\sqrt{2}}$ . Observe that the isometries  $F(\mathrm{O}(2)^* \times \mathrm{O}(2)^*)$  of  $S^3$  leave  $T_0$  invariant. The action of  $F(\mathrm{O}(2)^* \times \mathrm{O}(2)^*)$  on  $T_0$  can be calculated using the normalized coordinates  $[x_0, y_0] \in S^1 \times S^1 / \langle (-1, -1) \rangle$ , where  $[x_0, y_0]$  corresponds to the point  $x_0(\frac{1}{\sqrt{2}} \overline{y_0} i + \frac{1}{\sqrt{2}} y_0 j)$ . For  $(z_0, w_0) \in S^1 \times S^1$ , we have  $F(z_0, w_0)[x_0, y_0] = [z_0 x_0, w_0 y_0]$ . Also:

- (a)  $F(j, 1)[x_0, y_0] = [-\overline{x_0}, i y_0]$ . Viewed in the fundamental domain  $\Im(x_0) \geq 0$  for the involution on  $T_0 = \{(x_0, y_0)\}$  that multiplies by  $(-1, -1)$ , this rotates the  $y_0$ -coordinate through  $\pi/2$ , and reflects in the  $x_0$ -coordinate fixing the point  $i$ .
- (b)  $F(1, j)[x_0, y_0] = [i x_0, -\overline{y_0}]$ . Again viewing in the fundamental domain  $\Im(y_0) \geq 0$  in  $T_0$ , this rotates the  $x_0$ -coordinate through  $\pi/2$ , and reflects in the  $y_0$ -coordinate fixing the point  $i$ .

In fact, the restriction of  $F(\mathrm{O}(2)^* \times \mathrm{O}(2)^*)$  to  $T_0$  is exactly the group of all fiber-preserving isometries  $\mathrm{Isom}_f(T_0)$ . The Hopf fibers are the orbits of the action of  $F(S^1 \times \{1\})$  on  $T_0$ , so are the circles with constant  $y_0$ -coordinate. Using (a) and (b), we find that  $F(j, i)[x_0, y_0] = [\overline{x_0}, y_0]$  and  $F(i, j)[x_0, y_0] = [x_0, \overline{y_0}]$ . The elements  $F(z_0, w_0)$  act transitively on  $T_0$ , and only the two reflections  $F(i, j)$  and  $F(j, i)$  and their composition fix  $[1, 1]$  and preserve the fibers, so together they generate all the fiber-preserving isometries.

Since  $F(\mathrm{O}(2)^* \times \mathrm{O}(2)^*)$  contains (each of our groups)  $G$ , the image of  $T_0$  in  $M$  is a fibered submanifold  $K_0$ . When  $n = 1$ , the image of  $T_0$  in  $\mathcal{O}$  is a geodesic circle which is the center circle of a Möbius band, and when  $n > 1$  its image is a geodesic arc connecting two cone points of order 2, so  $K_0$  is a special Klein bottle.

DEFINITION 4.4.3. The special Klein bottle  $K_0$  is called the *base Klein bottle* of  $M(m, n)$ .

Since  $K_0$  is special, it has the meridional or longitudinal fibering according as  $n = 1$  or  $n > 1$ .

Since  $G$  acts by isometries on  $S^3$ , the subspace metric on  $T_0$  induces a metric on  $K_0$  such that the inclusion of  $K_0$  into  $M$  is isometric. Denote by  $\text{isom}_f(K_0, M)$  the connected component of the inclusion in the space of all fiber-preserving isometric embeddings of  $K_0$  into  $M$ . Since the isometries of  $M$  are fiber-preserving, their compositions with the inclusion determine a map  $\text{isom}(M) \rightarrow \text{isom}_f(K_0, M)$ . By composition with the inclusion, we may regard  $\text{isom}_f(K_0)$ , the connected component of the identity in the group of fiber-preserving isometries of  $K_0$ , as a subspace of  $\text{isom}_f(K_0, M)$ .

LEMMA 4.4.4. *If  $m > 1$  or  $n > 1$ , then  $\text{isom}(M) \rightarrow \text{isom}_f(K_0, M)$  is a homeomorphism. Moreover,*

- (i) *If  $n = 1$ , then the elements  $f(1, w_0)$  for  $w_0 \in S^1$  preserve  $K_0$ , and restriction of this subgroup of  $\text{isom}(M)$  gives a homeomorphism  $S^1 \rightarrow \text{isom}_f(K_0)$ .*
- (ii) *If  $n > 1$ , then the elements  $f(x_0, 1)$  for  $x_0 \in S^1$  preserve  $K_0$ , and restriction of this subgroup of  $\text{isom}(M)$  gives a homeomorphism  $S^1 \rightarrow \text{isom}_f(K_0)$ .*

PROOF. For injectivity, suppose that an element of  $\text{isom}(M)$  fixes each point of  $K_0$ . Since it is isotopic to the identity, it cannot locally interchange the sides of  $K_0$ . Since it is an isometry, this implies it is the identity on all of  $M$ .

For surjectivity, we first examine the action of  $\text{isom}(M)$  on special Klein bottles in  $M$ .

For the quotient orbifolds of the form  $(S^2; 2, 2)$ , the special suborbifolds are the portions of great circles running between the two cone points, and for those of the form  $(\mathbb{RP}^2; )$ , they are the images of great circles under  $S^2 \rightarrow \mathbb{RP}^2$ . For those of the form  $(S^2; 2, 2, m)$  with  $m > 2$ , the geodesic running between the two order-2 cone points is the unique special suborbifold. In all of these cases,  $\text{isom}(\mathcal{O})$  acts transitively on the special suborbifolds. In the remaining case of  $(S^2; 2, 2, 2)$ , there are three special suborbifolds corresponding to the three nonisotopic special Klein bottles in  $M$ , and  $\text{isom}(\mathcal{O})$  acts transitively on the special suborbifolds isotopic to  $K_0$ . Since all elements of  $\text{isom}(\mathcal{O})$  are induced by elements of  $\text{isom}(M)$ , it follows that in all cases,  $\text{isom}(M)$  acts transitively on the space of special Klein bottles in  $M$  that are isotopic to  $K_0$ .

Since  $\text{isom}(M)$  acts transitively on the space of special Klein bottles isotopic to  $K_0$ , it remains to check that any element of  $\text{isom}_f(K_0, M)$  that carries  $K_0$  to  $K_0$  is the restriction of an element of  $\text{isom}(M)$ .

Consider first the case when  $m > 1$  and  $n = 1$ , so  $G$  is  $F(D_{4m}^* \times \{1\})$  and  $K_0$  has the meridional fibering. The fiber-preserving isometry group  $\text{Isom}_f(K_0)$  is  $\text{Norm}(G)/G$  where  $\text{Norm}(G)$  is the normalizer of  $G$  in  $\text{Isom}_f(T_0)$ . The elements in  $F(C_{2m} \times \{1\})$  rotate in the  $x_0$ -coordinate, while the element  $F(j, 1)$  is as described in (a). So each element of  $G - C_{2k}$  leaves invariant a pair of circles each having constant  $x_0$ -coordinate. The union of these invariant circles for all the elements of  $G - C_{2k}$  must be invariant under the action of  $\text{Norm}(G)$  on  $T_0$ , so the identity component of  $\text{Norm}(G)$  consists only of  $F(\{1\} \times S^1)$ . Consequently the elements  $f(1, w_0)$  of  $\text{isom}(M)$  induce all elements of  $\text{isom}_f(K_0)$ , proving the surjectivity of  $\text{isom}(M) \rightarrow \text{isom}_f(K_0, M)$  and verifying assertion (i).

For  $m = 1$  and  $n > 1$ ,  $G$  is cyclic generated by  $F(\xi_{4n}^{n-1}, j)$  and  $K_0$  has the longitudinal fibering. Since  $F(1, j)$  is as described in (b), there is a pair of circles in  $T_0$ , each having constant  $y_0$ -coordinate and each invariant under all elements of  $G$  (these circles become the exceptional fibers in  $K_0$ ). Since these circles must be invariant under the normalizer of  $G$  in  $\text{Isom}(T_0)$ , the identity component of  $\text{Norm}(G)$  consists only of  $F(S^1 \times \{1\})$ . Therefore the isometries  $f(x_0, 1)$  with  $x_0 \in S^1$  of  $\text{isom}(M)$  induce all elements of  $\text{isom}_f(K_0)$ , proving the surjectivity of  $\text{isom}(M) \rightarrow \text{isom}_f(K_0, M)$  and verifying assertion (ii) for this case.

Finally, if both  $m > 1$  and  $n > 1$ , then  $G$  contains  $F(1, j)$  and  $K_0$  has the longitudinal fibering. Again, the identity component of  $\text{Norm}(G)$  is  $F(S^1 \times \{1\})$ , and the isometries  $f(x_0, 1)$  with  $x_0 \in S^1$  induce all of  $\text{isom}_f(K_0)$ .  $\square$

In the space of all smooth fiber-preserving embeddings of  $K_0$  in  $M$  (for the appropriate fibering on  $K_0$ ), let  $\text{emb}_f(K_0, M)$  denote the connected component of the inclusion.

LEMMA 4.4.5. *If either  $m > 1$  or  $n > 1$ , then the inclusion*

$$\text{isom}_f(K_0, M) \rightarrow \text{emb}_f(K_0, M)$$

*is a homotopy equivalence.*

PROOF. Let  $\mathcal{K}_0$  be the image of  $K_0$  in the quotient orbifold  $\mathcal{O}$  of the fibering on  $M$ . As we have seen, when  $K_0$  has the meridional fibering,  $\mathcal{K}_0$  is a one-sided geodesic circle in  $\mathcal{O}$ , and when  $K_0$  has the longitudinal fibering,  $\mathcal{K}_0$  is a geodesic arc connecting two order 2 cone points of  $\mathcal{O}$ . Let  $\text{emb}(\mathcal{K}_0, \mathcal{O})$  denote the connected component of the inclusion in the space of orbifold embeddings, and  $\text{isom}(\mathcal{K}_0, \mathcal{O})$  its subspace of isometric

embeddings, and let a subscript  $v$  as in  $\text{Diff}_v(K_0)$  indicate the vertical maps— those that take each fiber to itself. Consider the following diagram, which we call the main diagram:

$$\begin{array}{ccccc} \text{Isom}_v(K_0) \cap \text{isom}_f(K_0) & \longrightarrow & \text{isom}_f(K_0, M) & \longrightarrow & \text{isom}(\mathcal{K}_0, \mathcal{O}) \\ \downarrow & & \downarrow & & \downarrow \\ \text{Diff}_v(K_0) \cap \text{diff}_f(K_0) & \longrightarrow & \text{emb}_f(K_0, M) & \longrightarrow & \text{emb}(\mathcal{K}_0, \mathcal{O}) \end{array}$$

in which the vertical maps are inclusions. The left-hand horizontal arrows are inclusions, and the right-hand horizontal arrows take each embedding to the embedding induced on the quotient objects. By Theorem 3.6.10, the bottom row is a fibration. We will now examine the top row.

Suppose first that  $n = 1$ , so that  $\mathcal{O} = (\mathbb{R}\mathbb{P}^2; \cdot)$  and  $\mathcal{K}_0$  is the image of the unit circle  $U$  of  $S^2$ . For this case,  $\text{isom}(\mathcal{K}_0, \mathcal{O})$  can be identified with the unit tangent space of  $\mathbb{R}\mathbb{P}^2$ . For if we fix a unit tangent vector of  $\mathcal{K}_0$ , the image of this vector under an isometric embedding is a unit tangent vector to  $\mathbb{R}\mathbb{P}^2$ , and each unit tangent vector of  $\mathbb{R}\mathbb{P}^2$  corresponds to a unique isometric embedding of  $\mathcal{K}_0$ . To understand this unit tangent space, note first that the unit tangent space of  $S^2$  is  $\mathbb{R}\mathbb{P}^3$ , since each unit tangent vector to  $S^2$  corresponds to a unique element of  $\text{SO}(3) = \mathbb{R}\mathbb{P}^3$ . The unit tangent space of  $S^2$  double covers the unit tangent space of  $\mathbb{R}\mathbb{P}^2$ , so the latter must be  $L(4, 1)$ .

Since the isometries of  $M$  are all fiber-preserving, there is a commutative diagram

$$\begin{array}{ccc} \text{isom}(M) & \xrightarrow{\bar{h}} & \text{isom}(\mathcal{O}) \\ \tilde{\rho} \downarrow & & \rho \downarrow \\ \text{isom}_f(K_0, M) & \longrightarrow & \text{isom}(\mathcal{K}_0, \mathcal{O}) \end{array}$$

where  $\bar{h}$  is induced by the homomorphism  $h: \text{O}(2)^* \times S^3 \rightarrow \text{O}(3)$  defined near the beginning of this section. By Lemma 4.4.4, the restriction  $\tilde{\rho}$  is a homeomorphism, and from Table 2,  $\bar{h}$  is a homeomorphism. The restriction  $\rho$  is a 2-fold covering map, since there are two isometries that restrict to the inclusion on  $\mathcal{K}_0$ : the identity and the reflection across  $\mathcal{K}_0$ . This identifies the second map of the top row of the main diagram as the 2-fold covering map from  $\mathbb{R}\mathbb{P}^3$  to  $L(4, 1)$ , with fiber the vertical elements of  $\text{isom}_f(K_0)$ . We will identify  $\text{Isom}_v(K_0) \cap \text{isom}_f(K_0)$  as the fiber of this covering map, by checking that it is  $C_2$ , generated by the isometry  $f(1, i)$ . By part (i) of Lemma 4.4.4, the elements of  $\text{isom}_f(K_0)$  are induced by the isometries  $f(1, w_0)$  for  $w_0 \in S^1$ . Such an



isometry is vertical precisely when  $\bar{h}(1, w_0)$  acts as the identity or the antipodal map on  $U$ , since each fiber of  $K_0$  is the image of the circles in  $S^3$  which are the inverse images of antipodal points of  $U$  (since these are exactly the fibers of  $T_0$  that are identified by elements of  $G = F(D_{4m}^* \times \{1\})$ ). For  $x_0 \in U$ , we have  $\bar{h}(1, w_0)(x_0) = \begin{pmatrix} \bar{w}_0 & 0 \\ 0 & w_0 \end{pmatrix} (x_0) = \bar{w}_0^2 x_0$ . So  $\bar{h}(1, w_0)$  is the identity or antipodal map of  $U$  exactly when  $w_0 = \pm 1$  or  $\pm i$ . The cases  $w_0 = \pm 1$  give  $f(1, 1)$  and  $f(1, -1)$ , which are the identity on  $M$  since  $F(-1, 1) = F(1, -1) \in G$ . Since  $f(1, -1)$  is already in  $G$ ,  $f(1, i)$  and  $f(1, -i)$  are the same isometry on  $K_0$  and give the unique nonidentity element of  $\text{Isom}_v(K_0) \cap \text{isom}_f(K_0)$ .

Suppose now that  $m = 1$ . This time, both  $\tilde{\rho}$  and  $\rho$  are homeomorphisms, since  $\mathcal{K}_0$  is just a geodesic arc connecting the two order-2 cone points of  $\mathcal{O} = (S^2; 2, 2)$ . From Tables 1 and 2,  $\bar{h}: \text{isom}(M) \rightarrow \text{isom}(\mathcal{O})$  is just the projection from  $S^1 \times S^1$  to its second coordinate. The first coordinate is left multiplication of  $S^3$  by elements of  $S^1$ , which by part (ii) of Lemma 4.4.4 give exactly the elements of  $\text{isom}_f(K_0)$ . Since  $\bar{h}(x_0, 1)$  is the identity on  $S^2$  for all these  $x_0$ ,  $\text{isom}_f(K_0) = \text{Isom}_v(K_0) \cap \text{isom}_f(K_0)$ . So the top row of the main diagram is simply the product fibration  $S^1 \rightarrow S^1 \times S^1 \rightarrow S^1$ , where the second map is projection to the second coordinate.

Finally, if both  $m > 1$  and  $n > 1$ , the quotient orbifold is  $(S^2; 2, 2, m)$  and as seen in the proof of Lemma 4.4.4,  $\text{isom}(\mathcal{K}_0)$  is a single point. Again part (ii) of Lemma 4.4.4 identifies  $\text{isom}_f(K_0, M)$  with the vertical isometries  $\text{Isom}_v(K_0)$  that are isotopic to the identity. So the top row of the main diagram is  $S^1 \rightarrow S^1 \rightarrow \{1\}$ .

In all three cases, the top row of the main diagram is a fibration. The proof will be completed by showing that the rightmost and leftmost vertical arrows of the main diagram are homotopy equivalences.

Suppose first that  $n = 1$ . We have a commutative diagram whose vertical maps are inclusions:

$$\begin{array}{ccccc} \text{Isom}(\mathcal{O} \text{ rel } \mathcal{K}_0) & \longrightarrow & \text{isom}(\mathcal{O}) & \longrightarrow & \text{isom}(\mathcal{K}_0, \mathcal{O}) \\ \downarrow & & \downarrow & & \downarrow \\ \text{Diff}(\mathcal{O} \text{ rel } \mathcal{K}_0) & \longrightarrow & \text{diff}(\mathcal{O}) & \longrightarrow & \text{emb}(\mathcal{K}_0, \mathcal{O}) \end{array}$$

The bottom row is a fibration by Corollary 3.5.13, and we have already seen how to identify the top row with the covering fibration  $C_2 \rightarrow \mathbb{RP}^3 \rightarrow L(4, 1)$ . Each component of  $\text{Diff}(\mathcal{O} \text{ rel } \mathcal{K}_0)$  can be identified with  $\text{Diff}(D^2 \text{ rel } \partial D^2)$ , which is contractible by [64], so the left vertical arrow is a homotopy equivalence. The middle arrow is a homotopy equivalence by the main result of [19]. Consequently the right vertical

arrow is a homotopy equivalence, which is also the right vertical arrow of the main diagram.

We have already seen that part (i) of Lemma 4.4.4 identifies  $S^1$ , the group of isometries of the form  $f(1, w_0)$ , with  $\text{isom}_f(K_0)$ , so that  $f(1, i)$  is the nontrivial element of  $\text{Isom}_v(K_0) \cap \text{isom}_f(K_0)$ . The group  $\text{Diff}_v(K_0) \cap \text{diff}_f(K_0)$  consists of two contractible components, one in which the diffeomorphisms preserve the orientation of each fiber and the other in which they reverse it ( $\text{Diff}_v(K_0)$  consists of four contractible components, these two and two others represented by the same maps composed with a single Dehn twist about a vertical fiber). The identity map and  $f(1, i)$  are points in these two components, so the left vertical arrow of the main diagram is also a homotopy equivalence.

A detailed analysis of  $\text{Diff}_v(K_0) \cap \text{diff}_f(K_0)$  can proceed by regarding  $K_0$  as a circle bundle over  $S^1$ , letting  $s_0$  be a basepoint in  $S^1$  and  $C$  be the fiber in  $K_0$  which is the inverse image of  $s_0$ , and examining the commutative diagram

$$\begin{array}{ccccc}
 \text{Diff}_v(K_0 \text{ rel } C) \cap \text{diff}_f(K_0) & \longrightarrow & \text{Diff}_v(K_0) \cap \text{diff}_f(K_0) & \longrightarrow & \text{Diff}(C) \\
 \downarrow & & \downarrow & & \downarrow \\
 \text{Diff}_f(K_0 \text{ rel } C) \cap \text{diff}_f(K_0) & \longrightarrow & \text{diff}_f(K_0) & \longrightarrow & \text{emb}_f(C, K_0) \\
 \downarrow & & \downarrow & & \downarrow \\
 \text{diff}(S^1 \text{ rel } s_0) & \longrightarrow & \text{diff}(S^1) & \longrightarrow & \text{emb}(s_0, S^1)
 \end{array}$$

whose rows and columns are all fibrations (the first and middle rows using Theorem 3.4.4, the third row by the Palais-Cerf Restriction Theorem, the first and middle columns by Theorem 3.6.4, and the third column by Theorem 3.4.4). The spaces in this diagram are homotopy equivalent to the spaces shown here:

$$\begin{array}{ccccc}
 \mathbb{Z} & \longrightarrow & C_2 \times \mathbb{R} & \longrightarrow & C_2 \times S^1 \\
 \downarrow & & \downarrow & & \downarrow \\
 \mathbb{Z} & \longrightarrow & S^1 \times \mathbb{R} & \longrightarrow & S^1 \times S^1 \\
 \downarrow & & \downarrow & & \downarrow \\
 1 & \longrightarrow & S^1 & \longrightarrow & S^1
 \end{array}$$

When  $n > 1$ , the situation is quite a bit simpler. If  $m = 1$ ,  $\text{emb}(\mathcal{K}_0, \mathcal{O})$  is just the embeddings of an arc in  $S^2$  relative to two points, which is homotopy equivalent to  $\text{isom}(\mathcal{K}_0, \mathcal{O})$ . For the left vertical arrow,  $\text{Diff}_v(\mathcal{K}_0) \cap \text{diff}_f(K_0)$  has only one component, since a vertical diffeomorphism which reverses the direction of the fibers induces a nontrivial outer automorphism on  $\pi_1(K_0)$ . To see that  $\text{diff}_v(\mathcal{K}_0)$  is homotopy equivalent to a circle, we can fix a generic fiber  $C$  and a

point  $c_0$  in  $C$ , then lift a vertical diffeomorphism to a covering of  $\mathcal{K}_0$  by  $S^1 \times \mathbb{R}$  and equivariantly deform it to the isometry of  $S^1 \times \mathbb{R}$  that has the same effect on a lift of  $c_0$ . This can be carried out canonically using the  $\mathbb{R}$ -coordinate, so actually gives a deformation retraction to  $\text{isom}_v(K_0)$ . When  $m > 1$ , the situation is the same except that  $\text{isom}(\mathcal{K}_0, \mathcal{O})$  is a point and  $\text{emb}(\mathcal{K}_0, \mathcal{O})$  is contractible.  $\square$

### 4.5. Homotopy type of the space of diffeomorphisms

We continue to use the notation of Section 4.4. Our main technical result shows that parameterized families of embeddings of the base Klein bottle  $K_0$  in  $M$  can be deformed to families of fiber-preserving embeddings:

**THEOREM 4.5.1.** *If either  $m > 1$  or  $n > 1$ , then the inclusion*

$$\text{emb}_f(K_0, M) \rightarrow \text{emb}(K_0, M)$$

*is a homotopy equivalence.*

Its proof will be given in Sections 4.6, 4.7, and 4.8. From Theorem 4.5.1, we can deduce the Smale Conjecture for our 3-manifolds for all cases except  $M(1, 1)$ .

**THEOREM 4.5.2.** *If  $m > 1$  or  $n > 1$ , then the inclusion*

$$\text{Isom}(M(m, n)) \rightarrow \text{Diff}(M(m, n))$$

*is a homotopy equivalence.*

**PROOF OF THEOREM 4.5.2 ASSUMING THEOREM 4.5.1.** By Theorem 1.2.1, the inclusion is a bijection on path components, so we will restrict attention to the connected components of the identity map.

By Corollary 3.6.8, restriction of diffeomorphisms to embeddings defines a fibration

$$\text{Diff}_f(M \text{ rel } K_0) \cap \text{diff}_f(M) \rightarrow \text{diff}_f(M) \rightarrow \text{emb}_f(K_0, M) .$$

Since any diffeomorphism in this fiber is orientation-preserving, it cannot locally interchange the sides of  $K_0$ . Therefore the fiber may be identified with a subspace consisting of path components of  $\text{Diff}_f(S^1 \times D^2 \text{ rel } S^1 \times \partial D^2)$ . By Theorem 3.6.4, there is a fibration

$$\text{Diff}_v(S^1 \times D^2 \text{ rel } S^1 \times \partial D^2) \rightarrow \text{Diff}_f(S^1 \times D^2 \text{ rel } S^1 \times \partial D^2) \rightarrow \text{Diff}(D^2 \text{ rel } \partial D^2) ,$$

whose fiber is the group of vertical diffeomorphisms that take each fiber to itself. The base is contractible by [64], and it is not difficult to show that the fiber is contractible, so the restriction fibration becomes

$$\text{diff}_f(M \text{ rel } K_0) \rightarrow \text{diff}_f(M) \rightarrow \text{emb}_f(K_0, M)$$

with contractible fiber. Similarly there is a fibration

$$\text{diff}(M \text{ rel } K_0) \rightarrow \text{diff}(M) \rightarrow \text{emb}(K_0, M) .$$

The fact that it is a fibration is the Palais-Cerf Restriction Theorem, and the contractibility of the fiber uses [22]. We can now fit these into a diagram

$$\begin{array}{ccccc} \text{diff}_f(M \text{ rel } K_0) & \longrightarrow & \text{diff}_f(M) & \longrightarrow & \text{emb}_f(K_0, M) \\ \downarrow & & \downarrow & & \downarrow \\ \text{diff}(M \text{ rel } K_0) & \longrightarrow & \text{diff}(M) & \longrightarrow & \text{emb}(K_0, M) . \end{array}$$

The vertical maps are inclusions. By Theorem 4.5.1, the right hand vertical arrow is a homotopy equivalence. Since the fibers are both contractible, it follows that  $\text{diff}_f(M) \rightarrow \text{emb}_f(K_0, M)$ ,  $\text{diff}(M) \rightarrow \text{emb}(K_0, M)$ , and  $\text{diff}_f(M) \rightarrow \text{diff}(M)$  are homotopy equivalences.

The right-hand square of the previous diagram is the bottom square of the following diagram, whose vertical arrows are inclusions and whose horizontal arrows are obtained by restriction of maps to  $K_0$ :

$$\begin{array}{ccc} \text{isom}(M) & \longrightarrow & \text{isom}_f(K_0, M) \\ \downarrow & & \downarrow \\ \text{diff}_f(M) & \longrightarrow & \text{emb}_f(K_0, M) \\ \downarrow & & \downarrow \\ \text{diff}(M) & \longrightarrow & \text{emb}(K_0, M) \end{array}$$

From Lemma 4.4.4,  $\text{isom}(M) \rightarrow \text{isom}_f(K_0, M)$  is a homeomorphism, and from Lemma 4.4.5,  $\text{isom}_f(K_0, M) \rightarrow \text{emb}_f(K_0, M)$  is a homotopy equivalence. We conclude that  $\text{isom}(M) \rightarrow \text{diff}_f(M)$  is a homotopy equivalence, hence so is the composite  $\text{isom}(M) \rightarrow \text{diff}(M)$ .  $\square$

#### 4.6. Generic position configurations

Let  $S$  and  $T$  be smoothly embedded closed surfaces in a closed 3-manifold  $M$ . A point  $x$  in  $S \cap T$  is called a *singular* point if  $S$  is not transverse to  $T$  at  $x$ . There is a concept of finite multiplicity of such singular points, as described in Section 5 of [36] (another useful reference for these ideas is [8]). For a singular point  $x$  of finite multiplicity, either  $x$  is an isolated point of  $S \cap T$ , or  $S \cap T$  meets a small disc neighborhood  $D^2$  of  $x$  in  $T$  in a finite even number of smooth arcs running from  $x$  to  $\partial D^2$ , which are transverse intersections of  $S$  and  $T$  except at  $x$  (cf. Fig. 3, p. 1653 of [36]). Singular points are isolated on  $T$ , so by compactness  $S \cap T$  will have only finitely many singular points.

We say that the surfaces are *in generic position* if all singular points of intersection are of finite multiplicity. Notice that  $S \cap T$  is then a graph (with components that may be circles or isolated points) whose vertices are the singular points. Each vertex has even valence (possibly 0), since along each of the arcs of  $S \cap T$  that emanates from the singular point,  $S$  crosses over to the (locally) other side of  $T$ .

Finite multiplicity intersections have the additional property that if  $D^2 \times [-1, 1]$  is a product neighborhood of  $x$  which meets  $T$  in  $D^2 \times \{0\}$ , then for some  $u_0 > 0$ ,  $S$  meets  $D^2 \times \{u\}$  transversely for each  $u$  with  $0 < |u| \leq u_0$  [36, Lemma (5.4)]. Consequently, if  $T_u$  are the horizontal levels of a tubular neighborhood of  $T$ , with  $u \in (-1, 0) \cup (0, 1)$  if  $T$  is two-sided, and  $u \in (0, 1)$  if  $T$  is one-sided, then  $S$  is transverse to  $T_u$  for all  $u$  sufficiently close to 0.

Now we specialize to the base Klein bottle  $K_0 \subseteq M$ , where as usual  $M$  denotes an  $M(m, n)$  with either  $m > 1$  or  $n > 1$ . To set notation, let  $T$  be the torus and fix a 2-fold covering from  $T \times [-1, 1]$  to the twisted I-bundle neighborhood  $P$  of  $K_0$ , so that  $T \times \{0\}$  is a 2-fold covering of  $K_0$ , and so that for  $0 < u < 1$ , the image  $T_u$  of  $T \times \{u\}$  is a fibered torus. We call the  $T_u$  *levels*.

As usual, we write  $\pi_1(K_0) = \langle a, b \mid bab^{-1} = a^{-1} \rangle$ . For the meridional fibering, the fiber represents  $a$ , and for the longitudinal fibering, the exceptional fibers represent  $b$ , and the generic fiber  $b^2$ . We also recall from Section 4.4 that as a fibered submanifold of  $M(m, n)$ ,  $K_0$  has the meridional or longitudinal fibering according as  $n = 1$  or  $n > 1$ .

Each  $T_u$  is the boundary of a tubular neighborhood  $P_u$  of  $K_0$ , and also bounds the solid torus  $\overline{M - P_u}$ , which we denote by  $R_u$ . For each  $u > 0$ , the elements  $a$  and  $b^2$  generate the free abelian group  $\pi_1(T_u)$ , a subgroup of  $\pi_1(P_u)$ .

By a *meridian* in  $T_u$  we mean a simple loop in  $T_u$  which is essential in  $T_u$  but contractible in  $R_u$ . The meridians represent  $(a^m b^{2n})^{\pm 1}$  in  $\pi_1(T_u)$ . By a *longitude* in  $T_u$  we mean a simple loop in  $T_u$  which represents a generator of the infinite cyclic group  $\pi_1(R_u)$ . The longitudes represent elements of  $\pi_1(T_u)$  of the form  $(a^p b^{2q} (a^m b^{2n})^k)^{\pm 1}$ , where  $pn - qm = \pm 1$ , since these are precisely the elements whose intersection number with the meridians is  $\pm 1$ . This leads us to the following observation.

**LEMMA 4.6.1.** *Let  $\ell$  be a loop in  $T_u$  which represents  $a$  or  $b^2$  in  $\pi_1(T_u)$ . Then  $\ell$  is not a meridian of  $R_u$ . If  $(m, n) \neq (1, 1)$ , and  $\ell$  is a longitude of  $R_u$ , then  $\ell$  is isotopic in  $T_u$  to a fiber of the Seifert fibering of  $M(m, n)$ .*

**PROOF.** Since neither of  $m$  nor  $n$  is 0,  $\ell$  cannot be a meridian of  $R_u$ .

Suppose that  $\ell$  represents  $a$ . If  $n = 1$ , then  $\ell$  is a fiber of  $M(m, n)$ . If  $n > 1$ , then the longitudes are of the form  $(a^p b^{2q} (a^m b^{2n})^k)^{\pm 1}$ , where

$pn - qm = \pm 1$ . If  $a$  is a longitude, then  $q + kn = 0$ . But  $q$  and  $n$  are relatively prime, so this is impossible.

Suppose now that  $\ell$  represents  $b^2$ . If  $n > 1$ , then  $\ell$  is a fiber of  $M(m, n)$ . If  $n = 1$ , then the longitudes are of the form  $(a(a^m b^2)^k)^{\pm 1}$ . If  $b^2$  is a longitude, then  $1 + km = 0$ . But when  $n = 1$ , we have  $m > 1$ , so this is impossible.  $\square$

The lemma fails for  $M(1, 1)$ , for in that case an  $a$ -circle is a longitude of  $R_u$  which is not isotopic to a fiber of the longitudinal fibering, while a  $b^2$ -circle is a longitude not isotopic to a fiber of the meridional fibering.

If  $K$  is a Klein bottle in  $M$  that meets  $K_0$  in generic position, then the intersection of  $K$  with the nearby levels is restricted by the next proposition, which is the main result of this section.

**PROPOSITION 4.6.2.** *Suppose that  $M = M(m, n)$  with  $(m, n) \neq (1, 1)$ , and let  $K$  be a Klein bottle in  $M$  which is isotopic to  $K_0$  and meets  $K_0$  in generic position. Then there exists  $u_0 > 0$  so that for each  $u \leq u_0$ ,  $K$  is transverse to  $T_u$ , and each circle of  $K \cap T_u$  is either inessential in  $T_u$ , or represents  $a$  or  $b^2$  in  $\pi_1(T_u)$ .*

In order to prove Proposition 4.6.2, we introduce a special kind of isotopy. Suppose that  $L_0$  is an embedded surface in a closed 3-manifold  $N$ . A piecewise-linearly embedded surface  $S$  in  $N$  is said to be *flattened* (with respect to  $L_0$  and the choice of the  $L_u$ ) if it satisfies the following conditions.

- (1) There is a 4-valent graph  $\Gamma$  (possibly with components which are circles) contained in  $L_0$  such that  $S \cap L_0$  consists of the closures of some of the connected components of  $L_0 - \Gamma$ .
- (2) Each point  $p$  in the interior of an edge of  $\Gamma$  has a neighborhood  $U$  for which the quadruple  $(U, U \cap L_0, U \cap S, p)$  is PL homeomorphic to the configuration  $(\mathbb{R}^3, \{(x, y, z) \mid z = 0\}, \{(x, y, z) \mid \text{either } z = 0 \text{ and } x \geq 0, \text{ or } x = 0 \text{ and } z \geq 0\}, \{0\})$  (see Figure 4.1(a)).
- (3) Each vertex  $v$  of  $\Gamma$  has a neighborhood  $U$  for which the quadruple  $(U, U \cap L_0, U \cap S, v)$  is PL homeomorphic to the configuration  $(\mathbb{R}^3, \{(x, y, z) \mid z = 0\}, \{(x, y, z) \mid \text{either } z = 0 \text{ and } xy \leq 0, \text{ or } x = 0 \text{ and } z \geq 0, \text{ or } y = 0 \text{ and } z \leq 0\}, \{0\})$  (see Figure 4.1(b)).

In Figure 4.1(a), the graph  $\Gamma$  is the intersection of  $S$  with the  $y$ -axis. In Figure 4.1(b),  $\Gamma$  is the intersection of  $S$  with the union of the  $x$ - and  $y$ -axes, and in Figure 4.2, it is the intersection of the horizontal portion in  $S_{1/2} \cap L_0$  with the four vertical bands of  $S_{1/2}$ . The vertices of  $\Gamma$  are exactly the points that appear as the origin in a local picture as in Figure 4.1(b) (or Figure 4.3(b) below).

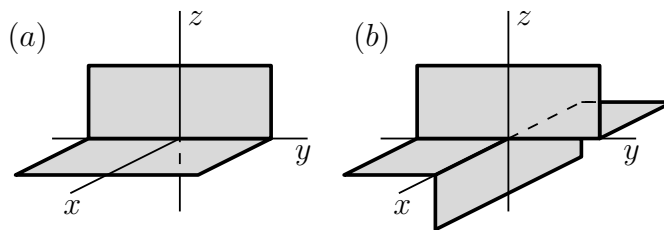

FIGURE 4.1. Flattened surfaces, local picture.

LEMMA 4.6.3. *Let  $S_0$  be a smoothly embedded surface in  $N$  which meets the one-sided surface  $L_0$  in generic position. Denote by  $L_u$  the level surfaces in a tubular neighborhood  $(L \times [-1, 1]) / ((x, u) \sim (\tau(x), -u))$  for some free involution  $\tau$  of  $L$  with quotient  $L_0$  (so  $L_u = L_{-u}$ ). Then for some  $u_0 > 0$ , there is a PL isotopy  $S_t$  from  $S_0$  to a PL embedded surface  $S_1$  such that*

- (i) *each  $S_t$  is transverse to  $L_u$  for  $0 < u \leq u_0$ , and*
- (ii)  *$S_1$  is flattened with respect to  $L_0$ .*

PROOF. Initially,  $S_0$  meets  $L_0$  in a graph, with tangencies at the vertices and transverse intersections on the open edges. We have already noted that there is a  $u_0 > 0$  so that  $S_0$  is transverse to  $L_u$  for all  $0 < u \leq u_0$ . The isotopy will only move  $S_0$  in the region where  $0 < u < u_0$ . For  $0 \leq t \leq 1$ , we denote by  $S_t$  the image of  $S_0$  at time  $t$ . With respect to  $u$ , points of  $S_t$  must move monotonically toward  $L_0$ , in such a way that the transversality required by condition (i) in the lemma is achieved.

Figure 4.2 illustrates the first portion of the isotopy, near a singular point  $x$  of  $S_0 \cap L_0$ . During the time  $0 \leq t \leq 1/2$ , a 2-disk neighborhood of  $x$  in  $S_0$  moves onto a 2-disk neighborhood of  $x$  in  $L_0$ . In a neighborhood  $U$  of  $x$ ,  $S_0 \cap L_0$  consists of  $x$  together with a (possibly empty) collection of arcs  $\alpha_1, \alpha_2, \dots, \alpha_{2n}$  emanating from  $x$ , at which  $S_0$  crosses alternately above and below  $L_0$  as one travels around  $x$  on  $S_0$ . There is a neighborhood of  $x$  for which the angles of intersection of  $S_0$  with  $L_0$  are close to 0; the isotopy moves points only within such a neighborhood. At the end of the initial isotopy, there is a neighborhood  $U$  of  $x$  for which  $S_{1/2} \cap L_0 \cap U$  is a regular neighborhood in  $L_0$  of  $\cup_{i=1}^{2n} \alpha_i$ . Near interior points of the  $\alpha_i$ ,  $S_{1/2}$  is positioned as in Figure 4.3(a), where  $L_0$  is the horizontal plane and  $S_{1/2}$  travels “up” on one side of  $\alpha_i$  and “down” on the other. These isotopies may be performed simultaneously near each singular point of intersection.

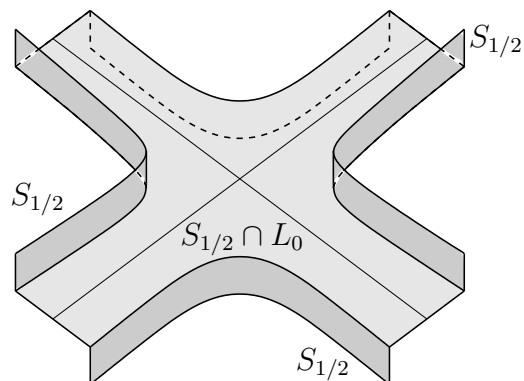

FIGURE 4.2. A portion of the partially flattened surface  $S_{1/2}$  near a point of  $S_0 \cap L_0$  that was an ordinary saddle tangency. The intersecting diagonal lines are in  $S_0 \cap L_0$ . The horizontal surface is in  $S_{1/2} \cap L_0$ , while the darker vertical strips are in  $S_{1/2}$  but not  $L_0$ .

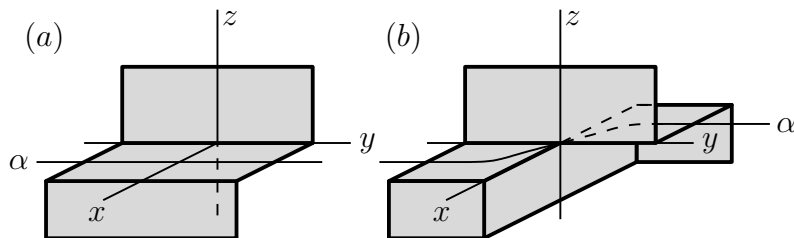

FIGURE 4.3. Portions of a flattened surface near an original intersection arc  $\alpha$ .

The remainder of the isotopy will move points only in a small neighborhood of the original (open) edges of  $S_0 \cap L_0$ . Consider the closure  $\alpha$  of such an edge. Initially,  $S_0$  and  $L_0$  were tangent at its endpoints (which may coincide), and nearly tangent near its endpoints, and  $S_{1/2}$  actually coincides with  $L_0$  at points of  $\alpha$  near the endpoints. On the remainder, we continue to flatten  $S_{1/2}$  so that it meets  $L_0$  in a neighborhood of  $\alpha$ , as shown locally in Figure 4.3(a).

When the two flattenings from the ends of  $\alpha$  meet somewhere in the middle, it might happen that both go “up” on the same side of  $\alpha$ , so that the flattening may be continued to achieve Figure 4.3(a) at all points of the interior of  $\alpha$ . It might happen, however, that one flattening goes “up” while the other goes “down” on the same side of



$\alpha$ . In that case, we flatten to the local configuration in Figure 4.3(b), adding one such crossover point on each such edge  $\alpha$ .

This process starting with  $S_{1/2}$  may be carried out simultaneously for all intersection edges, giving the desired isotopy ending with a flattened surface  $S_1$ .  $\square$

We call an isotopy as in Lemma 4.6.3, or the resulting PL surface, a *flattening* of  $S_0$ . By property (i) of the lemma, the collection of intersection circles in  $L_u$  for  $0 < u \leq u_0$  is changed only by isotopy in  $L_u$ . After flattening, each of these circles projects through  $S_1$  (i. e. vertical projection to the  $xy$ -plane in Figure 4.1) to an immersed circle lying in  $\Gamma$ , having a transverse self-intersection at each of its double points (which can occur only at vertices of  $\Gamma$ .)

**PROOF OF PROPOSITION 4.6.2.** Suppose first that the intersection  $K \cap K_0$  is transverse. Since  $K$  must meet every nearby level  $T_u$  transversely, it intersects  $P_u$  in Möbius bands and annuli, which after isotopy of  $K$  (keeping it transverse to level tori) may be assumed to be vertical in the I-bundle structure. The projection of  $T_u$  onto  $K_0$  maps circles of  $K \cap T_u$  onto circles of  $K \cap K_0$  either homeomorphically or by two-fold coverings. Only inessential and  $a$ - and  $b^2$ -circles can be inverse images of embedded circles in  $K_0$ . For suppose that a loop representing  $a^k b^{2\ell}$  covers an embedded circle. Then it must have zero intersection number with its image under the covering transformation  $\tau$  of  $T_u$  over  $K_0$ . Since  $a$  and  $b^2$  have intersection number 1 in  $T_u$ , and  $\tau(a) = a^{-1}$  and  $\tau(b^2) = b^2$ , the image represents  $a^{-k} b^{2\ell}$  and the intersection number is  $2k\ell$ . Therefore the proposition holds when  $K$  meets  $K_0$  transversely.

Suppose now that  $K \cap K_0$  contains singular points. By Lemma 4.6.3, we can flatten  $K$  near  $K_0$ , without changing the isotopy classes in  $T_u$  of the loops  $K \cap T_u$ . After the flattening,  $K \cap K_0$  consists of a valence 4 graph  $\Gamma$ , which is the image of the collection of disjoint simple closed curves  $K \cap T_u$  under a 2-fold covering projection, together with some of the complementary regions of  $\Gamma$  in  $K_0$ , which we will call the *faces*. Each edge of  $\Gamma$  lies in the closure of exactly one face. It is convenient to choose an I-fiber of  $P_{u_0}$  so that  $K \cap P_{u_0}$  lies in the union of  $K \cap K_0$  and the I-fibers that meet  $\Gamma$ .

Suppose for contradiction that one of the circles in  $K \cap T_u$  represents  $a^k b^{2\ell}$  with  $k\ell \neq 0$ . Since  $K$  is geometrically incompressible (if not, then  $M$  would contain an embedded projective plane), there is an isotopy of  $K$  in  $M$  which eliminates the circles of  $K \cap T_u$  that are inessential in  $T_u$ , without altering the remaining circles or destroying the flattened position of  $K \cap P_u$ .

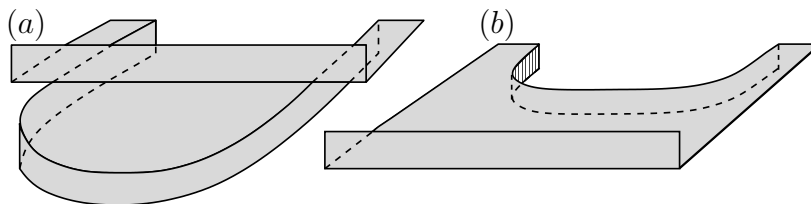

FIGURE 4.4. Removal of a bigon by isotopy. The picture shows a portion of  $K$  near a bigon face of  $K \cap K_0$ , and  $K_0$  is the horizontal plane containing the bigon. During the isotopy, the top vertical portion of  $K$  in (a) moves forward and the bottom one moves backward, ending with  $K$  in the position shown in (b). The bigon is eliminated from  $K \cap K_0$ , while the other two portions of intersection faces seen in (a) (which might be portions of the same face) are joined by a new horizontal band in  $K \cap K_0$  seen in (b).

At this point none of the components of  $\Gamma$  can be a circle. If so, then it would lie in a vertical annulus or Möbius band in  $K \cap P_u$ , and be the image of a 1 or 2-fold covering of a circle of  $K \cap T_u$ , but we have seen that only inessential,  $a$ -, and  $b^2$ -circles in  $T_u$  project along I-fibers to imbedded circles in  $K_0$ . So we may assume that  $K \cap T_u$  consists of disjoint circles each representing  $a^k b^{2\ell}$ . Since  $K$  is isotopic to  $K_0$ , each loop in  $T_u$  has zero mod 2-intersection number in  $M$  with  $K$ , and hence has even algebraic intersection number with  $K \cap T_u$ . Therefore  $K \cap T_u$  consists of an even number of these circles; denote them by  $A_1, A_2, \dots, A_{2r}$ .

The vertices of  $\Gamma$  are the images of the intersections of  $\cup A_i$  with  $\cup \tau(A_i)$  (note that by the properties of  $\Gamma$ ,  $\cup A_i$  and  $\cup \tau(A_i)$  meet transversely). As above, we compute the intersection number to be

$$(\cup A_i) \cdot (\cup \tau(A_i)) = (2r a^k b^{2\ell}) \cdot (2r a^{-k} b^{2\ell}) = 4r^2 2k\ell .$$

Since  $(\cup A_i) \cup (\cup \tau(A_i))$  is  $\tau$ -invariant, each vertex of  $\Gamma$  is covered by two intersections, so  $\Gamma$  has at least  $4r^2 |k\ell|$  vertices.

We claim that each edge of  $\Gamma$  runs between two distinct vertices of  $\Gamma$ . Supposing to the contrary, we would see a crossing configuration as Figure 4.1(b), for which starting at the origin and traveling along one of the four edges of  $\Gamma$  that meet there returns to the origin along one of the other three edges without passing through another vertex. Suppose, for example, that the edge starts with the positive  $y$ -axis in Figure 4.1(b). Consider the right-hand orientation  $(\vec{j}, -\vec{i}, \vec{k})$  at the

origin in Figure 4.1(b). Travel out the edge  $e$  along the positive  $y$ -axis. On the edge, we can make a continuous choice of local orientation  $(\vec{j}_t, -\vec{i}_t, \vec{k}_t)$  where  $\vec{j}_t$  is a tangent vector to the edge,  $-\vec{i}_t$  is the inward normal of  $K \cap K_0$ , and  $\vec{k}_t$  is the inward normal of  $\overline{K - K_0}$ . Returning to the initial point of the edge, one approaches the origin along either the negative  $y$ -axis or the positive or negative  $x$ -axis, but on each of these axes the orientation  $(\vec{j}_t, -\vec{i}_t, \vec{k}_t)$  is left-handed in Figure 4.1(b), contradicting the fact that  $M$  is orientable.

A similar argument shows that each face of  $K \cap K_0$  has an even number of edges. Successive edges of a face meet at configurations as in Figure 4.1(b), and the orientations described in the previous paragraph change to the opposite orientation of  $M$  each time one passes to a new edge.

Consider a face that is a bigon. Since no edge has equal endpoints, the face must have two distinct vertices, as in Figure 4.4(a). The isotopy of  $K$  described in Figure 4.4 eliminates this bigon and adds a band to  $K \cap K_0$ ; this band is a (2-dimensional) 1-handle attached onto previous faces of  $K \cap K_0$ , and either combines two previous faces or is added onto a single previous face. Repeating, we move  $K$  by isotopy (not changing the isotopy classes of the loops of  $K \cap T_u$ ) to eliminate all faces that are bigons. No component of  $\Gamma$  can be a circle, since as before this would force  $K \cap T_u$  to have a component that is inessential or is an  $a$ - or  $b^2$ -curve. So each face of  $K \cap K_0$  now contains at least 4 vertices.

The Euler characteristic of  $K \cap P_u$  is at least  $-2r$ , since  $\chi(K) = 0$  and  $K \cap P_u$  has exactly  $2r$  boundary components. Letting  $V$ ,  $E$ , and  $F$  denote the number of vertices, edges, and faces of  $K \cap K_0$ , we have  $E = 2V$  and  $F \leq V/2$  (since each edge lies in exactly one face and each face has at least 4 edges). Therefore  $-2r \leq \chi(K \cap P_u) = \chi(K \cap K_0) \leq -V/2$  (note that the latter estimate does not require that the faces themselves have Euler characteristic 1). Since  $V \geq 4r^2|k\ell|$ , it follows that  $r|k\ell| \leq 1$ , forcing  $r = |k\ell| = 1$ ,  $\chi(K \cap K_0) = -2$ ,  $V = 4$ , and  $F = 2$ . That is,  $K \cap K_0$  consists of two faces, each a 4-gon, meeting at their four vertices. Since  $|k\ell| = 1$ ,  $\Gamma$  is the image of two embedded circles of  $T_u$  each representing  $a^{\pm 1}b^{\pm 2}$ . Since  $\chi(K \cap P_u) = \chi(K \cap K_0) = -2$  and  $\chi(K) = 0$ , each of these circles must bound a disk in  $R_u$ . This contradicts the hypothesis that  $(m, n) \neq (1, 1)$ .  $\square$

Figure 4.5 shows  $K \cap K_0$  for a Klein bottle  $K$  in  $M(1, 1)$  that is the flattening of a Klein bottle that meets every  $T_u$  close to  $K_0$  in longitudes not homotopic to fibers, i. e. in loops representing  $ab^2$ .

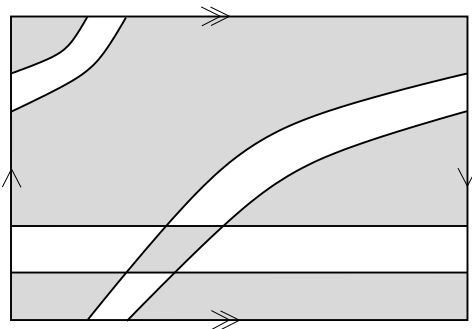

FIGURE 4.5. The shaded region shows  $K \cap K_0$  in  $K_0$  for a case when  $r = |k\ell| = 1$ . Necessarily  $M = M(1, 1)$ , which is excluded by hypothesis.

#### 4.7. Generic position families

In this section, we achieve the necessary generic position for a parameterized family. As usual,  $M = M(m, n)$  with at least one of  $m > 1$  or  $n > 1$ .

**PROPOSITION 4.7.1.** *Let  $F: D^k \rightarrow \text{Emb}(K_0, M)$  be a parameterized family of embeddings of the standard Klein bottle  $K_0$  into  $M$ . Then every open neighborhood of  $F$  in  $C^\infty(D^k, \text{Emb}(K_0, M))$  contains a map  $G: D^k \rightarrow \text{Emb}(K_0, M)$  for which  $G(t)(K_0)$  is in generic position with respect to  $K_0$  for all  $t \in D^k$ . Moreover, we may select  $G$  to be homotopic to  $F$  within the given neighborhood.*

**PROOF.** From Lemma (5.2) of [36] (see also [8]), a  $G$  with each  $G(t)(K_0)$  in generic position exists, and we need only verify that it may also be selected to be homotopic to  $F$  within the given neighborhood  $V$ .

Each  $F(t)$  determines a bundle map from the restriction  $E$  of the tangent bundle of  $M$  to  $K_0$  to the restriction  $E(t)$  of the tangent bundle of  $M$  to  $F(t)(K_0)$ ; in the directions tangent to  $K_0$ , it is the differential of  $F(t)$ , and it takes unit normals to unit normals. At each  $t$ , the Fréchet manifold of  $C^\infty$ -sections of  $E(t)$  whose image vectors all have length less than some sufficiently small  $\epsilon$  corresponds, using the exponential map, to a neighborhood  $W_\epsilon(t)$  of  $F(t)$  in  $\text{Emb}(K_0, M)$ . In particular, the zero section corresponds to  $F(t)$ . Since  $D^k$  is compact, we may fix a uniform value of  $\epsilon$  for all  $F(t)$ .

An  $\epsilon$ -small section  $s(t)$ , corresponding to an embedding  $L(t)$ , is isotopic to the zero section by sending each  $s(x)$  to  $(1 - s)s(x)$ . Via the exponential, this becomes a homotopy  $L_s$  with each  $L_0(t) = L(t)$  and  $L_1(t) = F(t)$ , that is, a homotopy from  $L$  to  $F$  as elements of  $C^\infty(D^k, \text{Emb}(K_0, M))$ . With respect to coordinates on  $E(t)$ , all partial

derivatives of  $s(t)$  move closer to zero as  $s$  goes from 0 to 1, so those of  $L_s$  in  $M$  move closer to those of  $F$ . Consequently, provided that  $\epsilon$  was small enough and  $G$  was selected so that each  $G(t)$  was in  $W_\epsilon(t) \cap V$ , the  $G_s$  will remain in  $V$ .  $\square$

We are now ready for the main result of Sections 4.6 and 4.7.

**THEOREM 4.7.2.** *Let  $F: D^k \rightarrow \text{Emb}(K_0, M)$  be a parameterized family of Klein bottles in  $M$ . Assume that if  $t \in \partial D^k$ , then  $F(t)$  is fiber-preserving and  $F(t)(K_0) \neq K_0$ . Then  $F$  is homotopic relative to  $\partial D^k$  to a family  $G$  such that for each  $t \in D^k$ , there exists  $u > 0$  so that  $G(t)(K_0)$  meets  $T_u$  transversely and each circle of  $G(t)(K_0) \cap T_u$  is either inessential in  $T_u$ , or represents a or  $b^2$  in  $\pi_1(T_u)$ .*

**PROOF.** We first note that any embedded Klein bottle in  $M$  must meet  $K_0$ , since otherwise it would be embedded in the open solid torus  $M - K_0$ , so would admit an embedding into 3-dimensional Euclidean space.

Recall that  $M(m, n)$  is constructed from the I-bundle  $P$  over  $K_0$  by attaching a solid torus. There is a  $u$ -coordinate on  $P$ ,  $0 \leq u \leq 1$ , such that the points with  $u = 0$  are  $K_0$  and for each  $0 < u \leq 1$ , the points with  $u$ -coordinate equal to  $u$  are a “level” torus  $T_u$ . Fixing a parameter  $t \in \partial D^k$ , let  $f: F(t)^{-1}(P - K_0) \rightarrow I$  be the composition of  $F(t)$  with projection to the  $u$ -coordinate of  $P - K_0$ . Since  $F(t)(K_0)$  must meet  $K_0$ , and by hypothesis,  $F(t)(K_0)$  does not equal  $K_0$ , the image of  $f$  contains an interval. By Sard’s Theorem, almost all values of  $u$  are regular values of  $f$ , so there is some level  $T_u$  such that  $F(t)(K_0)$  meets  $T_u$  transversely.

Since transversality is an open condition and  $\partial D^k$  is compact, there is a finite collection of open sets in  $D^k$  whose union contains  $\partial D^k$  and such that on each open set, there is a corresponding level  $T_u$  such that  $F(t)(K_0)$  meets  $T_u$  transversely for every  $t$  in the open set. At points of  $\partial D^k$ , the intersection curves are fibers, so must be either  $a$ - or  $b^2$ -circles in  $\pi_1(T_u)$ . Choose a collar neighborhood  $U = \partial D^k \times I$  of  $\partial D^k$ , with  $\partial D^k \times \{0\} = \partial D^k$ , such that the closure  $\bar{U}$  is contained in the union of these open sets. Since transversality is an open condition, there is an open neighborhood  $V$  of  $F$  in  $C^\infty(D^k, C^\infty(K_0, M))$  such that for any map  $G$  in  $V$  and any  $t \in U$ ,  $G(t)$  is transverse to one of the corresponding levels, and  $G(t)(K_0)$  intersects that level in loops representing either  $a$  or  $b^2$ .

Apply Proposition 4.7.1 to obtain a homotopy  $G'_s$  from  $F$  to a map  $G'_1$  for which  $G'_1(t)$  meets  $K_0$  in generic position for every  $t \in D^k$ , and such that each  $G'_s$  lies in  $V$ . Define a new homotopy  $G_s$  that equals

$G'_s$  on  $\overline{D^k - U}$  and carries out only the portion of  $G'_s$  from  $s = 0$  to  $s = r$  on each  $\partial D^k \times \{r\} \subset U$ . In particular,  $G_s$  is a homotopy relative to  $\partial D^k$ .

At each point  $t$  of  $U$ ,  $G_s(t)$  lies in  $V$  so is transverse to some level  $T_u$  and  $G_s(K_0)$  intersects that level in loops representing either  $a$  or  $b^2$ . On  $\overline{D^k - U}$ ,  $G_s(K_0)$  meets  $K_0$  in generic position, so by Proposition 4.6.2, it meets all  $T_u$ , for  $u$  sufficiently close to 0, transversely in loops which are either inessential in  $T_u$  or represent  $a$  or  $b^2$  in  $\pi_1(T_u)$ .  $\square$

#### 4.8. Parameterization

In this section we will complete the proof of Theorem 4.5.1. By definition, both  $\text{emb}(K_0, M)$  and  $\text{emb}_f(K_0, M)$  are connected, so  $\pi_0(\text{emb}(K_0, M), \text{emb}_f(K_0, M)) = 0$ . To prove that the higher relative homotopy groups vanish, we begin with a smooth map  $F: D^k \rightarrow \text{emb}(K_0, M)$ , where  $k \geq 1$ , which takes all points of  $\partial D^k$  to  $\text{emb}_f(K_0, M)$ . We will deform  $F$ , possibly changing the embeddings at parameters in  $\partial D^k$  but retaining the property that they are fiber-preserving, to a family which is fiber-preserving at every parameter. In fact, all deformations will be relative to  $\partial D^k$ , except for the first step.

*Step 1: Obtain generic position*

In order to apply Theorem 4.7.2, we must ensure that no  $F_t(K_0)$  equals  $K_0$  for  $t \in \partial D^k$ . Select a smooth isotopy  $J_s$  of  $M$ ,  $0 \leq s \leq 1$ , with the following properties:

- (a)  $J_0$  is the identity of  $M$ .
- (b) Each  $J_s$  is fiber-preserving.
- (c)  $J_1(K_0) \neq F(t)(K_0)$  for any  $t \in \partial D^k$ .

One construction of  $J_s$  is as follows. As elaborated in Section 4.4, the image of  $K_0$  in the quotient orbifold  $\mathcal{O}$  of the Hopf fibering is either a geodesic arc or a geodesic circle. Let  $A$  denote the image, let  $S$  be the endpoints of  $A$  if  $A$  is an arc and the empty set if  $A$  is a circle, and let  $T$  be the inverse image of  $S$  in  $M$ . Consider an isotopy  $j_t$  of  $\mathcal{O}$ , relative to  $S$ , that moves  $A$  to an arc or circle  $A'$  of large length.

By Theorem 3.6.4, the map  $\text{Diff}_f(M \text{ rel } T) \rightarrow \text{Diff}(\mathcal{O} \text{ rel } S)$  induced by projection is a fibration, so  $j_t$  lifts to an isotopy  $J_t$  of  $M$  with  $J_0$  the identity map of  $M$ . The image of  $J_1(K_0)$  is  $A'$ . Since  $F(t)$  is fiber-preserving for each  $t \in \partial D^k$ , its image is an arc or circle, and by compactness of  $\partial D^k$ , there is a maximum value for the lengths of these images. Provided that  $A'$  was selected to have length larger than this maximum,  $J_1(K_0)$  cannot equal any  $F(t)(K_0)$  for  $t \in \partial D^k$ .

We now perform a deformation  $F_s$  of  $F$  such that each  $F_s(t) = J_s^{-1} \circ F(t)$ . At each  $t \in \partial D^k$ , each  $F_s(t)$  is fiber-preserving, and  $F_1(t)(K_0) = J_1^{-1}(F(t)(K_0)) \neq K_0$ . We can now apply Theorem 4.7.2 to further deform  $F$  relative to  $\partial D^k$  so that for each  $t$ , there is a value  $u$ ,  $0 < u \leq 1$ , so that

- (1)  $F(t)$  is transverse to  $T_u$ .
- (2) Every circle of  $K_t \cap T_u$  is either inessential in  $T_u$ , or represents either  $a$  or  $b^2$  in  $\pi_1(T_u)$ .

From now on, we will write  $K_t$  for  $F(t)(K_0)$ .

*Step 2:* Eliminate inessential intersection circles

The next step is to get rid of inessential intersections. Consider a single  $K_t$  and its associated level  $T_u$ . Notice first that each circle  $c$  of  $K_t \cap T_u$  that bounds a (necessarily unique) 2-disk  $D_T(c)$  in  $T_u$  also bounds a unique 2-disk  $D_K(c)$  in  $K_t$ , since  $K_t$  is geometrically incompressible. We claim that if  $D_K(c)$  is innermost among all such disks on  $K_t$ , then the interior of  $D_K(c)$  is disjoint from  $T_u$ . If not, then there is a smaller disk  $E$  in  $D_K(c)$  such that  $\partial E$  is essential in  $T_u$  and the interior of  $E$  is disjoint from  $T_u$ . Now  $E$  cannot be contained in  $P_u$ , since  $T_u$  is incompressible in  $P_u$ , so  $E$  must be a meridian disk of  $R_u$ . But then,  $\partial E$  is a circle of  $K_t \cap T_u$  which is essential in  $T_u$  but does not represent either  $a$  or  $b^2$ , contradicting (2) and establishing the claim. We conclude that if  $D_K(c)$  is innermost, then  $D_K(c)$  and  $D_T(c)$  bound a unique 3-ball  $B(c)$  in  $M$  that meets  $T_u$  only in  $D_T(c)$ .

We now follow the procedure of Hatcher described in [23, 25] to deform the family  $F$  to eliminate the circles of  $K_t \cap T_u$  that are inessential in  $T_u$ . It is not difficult to adapt the procedure to our situation, in fact a few simplifications occur, but since this is a crucial part of our argument and these methods are unfamiliar to many, we will navigate through the details. We will follow [25], as it is an easier read than [23], and its numbered formulas are convenient for referencing in our discussion. Start at the proof of the main theorem on p. 2 of [25]. Our  $K_t$  and  $T_u$  are in the role of the surfaces  $M_t$  and  $N_i$  in [25]. We ignore the points called  $p_t$  there, which are irrelevant for us (since a loop can bound at most one disk in  $K_t$  or  $T_u$ ). Only notational substitutions are needed to obtain the conditions (1)-(3) and (5)-(6),  $(5_\epsilon)$ , and  $(6_\epsilon)$  in [25] (condition (4) there concerns the irrelevant  $p_t$ ), and the conditions called (a) and (b) there are assumed inductively as before. We have already seen that the disks  $D_K(c_t)$  and  $D_T(c_t)$  bound a unique 3-ball  $B(c_t)$ — this replaces the hypothesis of the main theorem of [25] that any two essential 2-spheres in  $M$  are isotopic. The argument that

the boundary of  $B(c_t)$  has a corner with angle less than  $\pi$  along  $c_t$  applies in our case, since  $T_u$  cannot be contained in the 3-ball  $B(c_t)$ .

The individual isotopies that make up the deformations called  $M_{tu}$  in [25] (so they would be called  $K_{tu}$  for us) are constructed as before. A crucial point in Hatcher's method is that if the isotopies pushing  $D_K(c_t)$  and  $D_K(c'_t)$  across  $B(c_t)$  and  $B(c'_t)$  overlap in time, then the balls  $B(c_t)$  and  $B(c'_t)$  must be disjoint, ensuring that the isotopies have disjoint support and do not interfere with each other. The verification that such a  $B(c_t)$  and  $B(c'_t)$  must be disjoint proceeds as in [25]: If the isotopies overlap in time, then

- (i)  $D_K(c_t)$  is disjoint from  $D_K(c'_t)$  (condition (5 $\epsilon$ )),
- (ii)  $D_T(c_t)$  and  $D_T(c'_t)$  lie in different levels  $T_u$  and  $T_{u'}$  (condition (6 $\epsilon$ )), and
- (iii)  $D_K(c_t)$  is disjoint from  $T_{u'}$  and  $D_K(c'_t)$  is disjoint from  $T_u$  (condition (b)).

Conditions (i)-(iii) show that the boundaries of  $B(c_t)$  and  $B(c'_t)$  are disjoint, so  $B(c_t)$  and  $B(c'_t)$  are either disjoint or nested. But neither  $T_u$  nor  $T_{u'}$  is contained in a 3-ball in  $M$ , so nesting would contradict (iii). The remainder of the proof is completed without significant modification.

At the end of this process, for each  $t \in D^k$ , there is a value  $u > 0$  so that in place of (2) above we have

- (2') Every intersection circle of  $K_t$  with  $T_u$  represents either  $a$  or  $b^2$  in  $\pi_1(T_u)$ .

*Step 3:* Make the intersection circles fibers

Since  $a$  and  $b^2$  are nontrivial elements of  $\pi_1(M)$ , the circles of  $K_t \cap T_u$  are essential in  $K_t$  as well, so each component of  $K_t \cap R_u$  must be either an annulus or a Möbius band. In fact, Möbius bands cannot occur. For the center circle of such a Möbius band would have intersection number 1 with  $K_t$  and intersection number 0 with  $K_0$ , contradicting the fact that  $K_t$  is isotopic to  $K_0$ .

We will use the procedure of [23, 25], this time to pull the annuli  $K_t \cap R_u$  out of the  $R_u$ . The details of adapting [23, 25] are not quite as straightforward as in Step 2. Again, the  $K_t$  and  $T_u$  are in the role of  $M_t$  and  $N_t$  respectively, and the points  $p_t$  are irrelevant. Setting notation, for each parameter  $t$  in a ball  $B_i$  in  $D^k$ ,  $K_t$  is transverse to a level  $T_{u_i}$ , and  $K_t \cap R_{u_i}$  is a collection of annuli. These annuli are in the role of the disks  $D_M(c)$  of [25]. Denote by  $C_t^i$  the annuli of  $K_t \cap R_{u_i}$  whose boundary circles are not isotopic in  $T_{u_i}$  to fibers. Notice that  $C_t^i$  is empty for parameters  $t$  in  $\partial D^k$ . By condition (2') and Lemma 4.6.1,



any circle of  $K_t \cap R_u$  that is not isotopic in  $T_u$  to a fiber is also not a longitude of  $R_u$ . So each such annulus  $a_t$  is parallel across a region  $W(a_t)$  in  $R_{u_i}$  to a uniquely determined annulus  $A_t$  in  $T_{u_i}$ .

Let  $C_t$  be the union of the  $C_t^i$  for which  $t \in B_i$ . Any two annuli of  $C_t$  are either nested or disjoint on  $K_t$ . Again we consider functions  $\varphi_t: C_t \rightarrow (0, 1)$  such that  $\varphi_t(a_t) < \varphi_t(a'_t)$  whenever  $a_t \subset a'_t$ ; this is the version of condition (5) needed for our case. For example, we may take  $\varphi_t(a_t)$  to be the area in  $K_0$  of the inverse image of  $a_t$  with respect to the embedding  $K_0 \rightarrow K_t$ , where the area of  $K_0$  is normalized to 1. The transversality trick of [25] achieves condition (6) as before, conditions  $(5_\epsilon)$  and  $(6_\epsilon)$  are again true by compactness, and conditions (a) and (b) are assumed inductively.

The angles of the regions  $W(a_t)$  along the circles  $a_t \cap T_{u_i}$  are less than  $\pi$ , this time simply because  $a_t$  is contained in  $R_{u_i}$ .

Again, the key point in defining the isotopies that pull the  $a_t$  across the regions  $W(a_t)$  and out of the  $R_{u_i}$  is that if two of the isotopies on such regions  $W(a_t)$  and  $W(a'_t)$  overlap in time, then  $W(a_t)$  and  $W(a'_t)$  must be disjoint. When they do overlap in time, we have

- (i)  $a_t$  is disjoint from  $a'_t$  (condition  $(5_\epsilon)$ ), and
- (ii)  $A_t$  and  $A'_t$  lie in different levels  $T_u$  and  $T_{u'}$  (condition  $(6_\epsilon)$ ).

We also have

- (iii)  $a_t$  is disjoint from  $T_{u'}$ , and  $a'_t$  is disjoint from  $T_u$ .

To see this, choose notation so that  $T_{u'} \subset R_u$ . Then  $a'_t$  is disjoint from  $T_u$  since  $a'_t \subset R_u$ . If  $a_t$  were to meet  $T_{u'}$ , then there would be a circle of  $a_t \cap T_{u'}$  that is parallel in  $\overline{R_u - R_{u'}}$  to a circle of  $a_t \cap T_u$ . The latter is not a longitude of  $R_u$ , so the circle of  $a_t \cap T_{u'}$  is not a longitude of  $R_{u'}$ . So  $a_t$  contains an annulus of  $K_t \cap R_{u'}$  that is in  $C_t$ , contradicting condition  $(5_\epsilon)$  (that is, such an annulus would already have been eliminated earlier in the isotopy).

Conditions (i) and (ii) show that the boundaries of  $W(a_t)$  and  $W(a'_t)$  are disjoint, so  $W(a_t)$  and  $W(a'_t)$  are either disjoint or nested. Suppose for contradiction that they are nested. Again we choose notation so that  $R_{u'} \subset R_u$ . Since  $a_t$  is disjoint from  $T_{u'}$ , and  $a'_t \subset W(a_t)$ , we must have  $R_{u'} \subset W(a_t)$ . It follows that  $W(a_t)$  contains a loop that generates  $\pi_1(R_{u'})$  and hence generates  $\pi_1(R_u)$ . But  $W(a_t)$  is a regular neighborhood of the annulus  $a_t$ , and the boundary circles of  $a_t$  were not longitudes of  $R_u$ , so this is contradictory. The remaining steps of the argument require no non-obvious modifications.

At the end of this process, we have in addition to (1) that

- (2'') Every circle of  $K_t \cap T_u$  is isotopic in  $T_u$  to a fiber of the Seifert fibering on  $M$ .

*Step 4:* Establish lemmas needed for the final step

To complete the argument, we require two technical lemmas.

LEMMA 4.8.1. *Let  $T$  be a torus with a fixed  $S^1$ -fibering, and let  $C_n = \cup_{i=1}^n S_i$  be a union of  $n$  distinct fibers. Then  $\text{emb}_f(C_n, T) \rightarrow \text{emb}(C_n, T)$  is a homotopy equivalence. The same holds for the Klein bottle with either the meridional fibering or the longitudinal singular fibering.*

PROOF. First consider a surface  $F$  other than the 2-sphere, the disk, or the projective plane, with a base point  $x_0$  in the interior of  $F$  and an embedding  $S^1 \subset F$  with  $x_0 \in S^1$  which does not bound a disk in  $F$ . In the next paragraph, we will sketch an argument using [19] that  $\text{emb}((S^1, x_0), (\text{int}(F), x_0))$  has trivial homotopy groups. The approach is awkward and unnatural, but we have found no short, direct way to deduce this fact from [19] or other sources.

By the Palais-Cerf Restriction Theorem, there is a fibration

$$\text{Diff}(F \text{ rel } S^1) \cap \text{diff}(F, x_0) \rightarrow \text{diff}(F, x_0) \rightarrow \text{emb}((S^1, s_0), (\text{int}(F), x_0)) .$$

Since  $F$  is not the 2-sphere, disk, or projective plane, Proposition 2 of [19] shows that  $\text{diff}(F, x_0)$  has the same homotopy groups as  $\text{diff}_1(F, x_0)$ , the subgroup of diffeomorphisms that induce the identity on the tangent space at  $x_0$ , and by Theorem 2 of [19], the latter is contractible. So we have isomorphisms

$$\pi_{q+1}(\text{emb}((S^1, s_0), (\text{int}(F), x_0))) \cong \pi_q(\text{Diff}(F \text{ rel } S^1))$$

for  $q \geq 1$ , and

$$\pi_1(\text{emb}((S^1, s_0), (\text{int}(F), x_0))) \cong \pi_0(\text{Diff}(F \text{ rel } S^1) \cap \text{diff}(F, x_0)) .$$

Proposition 6 of [19] shows that the components of  $\text{Diff}(F \text{ rel } S^1)$  are contractible, so it remains to see that only one component of  $\text{Diff}(F \text{ rel } S^1)$  is contained in  $\text{diff}(F, x_0)$ . That is, if  $h \in \text{Diff}(F \text{ rel } S^1) \cap \text{diff}(F, x_0)$ , then  $h$  is isotopic to the identity relative to  $S^1$ . This is an exercise in surface theory, using Lemma 1.4.2 of [71].

We now start with the torus case of the lemma. Choose notation so that the  $S_i$  lie in cyclic order as one goes around  $T$ , and fix basepoints  $s_i$  in  $S_i$  for each  $i$ . Consider the diagram

$$\begin{array}{ccccc} \text{emb}_f(S_n, T \text{ rel } s_n) & \longrightarrow & \text{emb}_f(S_n, T) & \longrightarrow & \text{emb}(s_n, T) \\ \downarrow & & \downarrow & & \downarrow = \\ \text{emb}(S_n, T \text{ rel } s_n) & \longrightarrow & \text{emb}(S_n, T) & \longrightarrow & \text{emb}(s_n, T) . \end{array}$$

The first row is a fibration by Corollary 3.8.6 and the second by the Palais-Cerf Restriction Theorem. The fiber of the top row is homeomorphic to  $\text{Diff}_+(S_n \text{ rel } s_n)$ , the group of orientation-preserving diffeomorphisms, which is contractible. We have already seen that the fiber of the second row is contractible. Therefore the middle vertical arrow is a homotopy equivalence. For  $n = 1$ , this completes the proof, so we assume that  $n \geq 2$ .

Let  $A$  be the annulus that results from cutting  $T$  along  $S_n$ , and let  $A_0$  be the interior of  $A$ . Consider the diagram

$$\begin{array}{ccccc} \text{emb}_f(S_{n-1}, A_0 \text{ rel } s_{n-1}) & \longrightarrow & \text{emb}_f(S_{n-1}, A_0) & \longrightarrow & \text{emb}(s_{n-1}, A_0) \\ \downarrow & & \downarrow & & \downarrow = \\ \text{emb}(S_{n-1}, A_0 \text{ rel } s_{n-1}) & \longrightarrow & \text{emb}(S_{n-1}, A_0) & \longrightarrow & \text{emb}(s_{n-1}, A_0) . \end{array}$$

As in the previous diagram, the rows are fibrations. As before, the fibers are contractible, so the middle vertical arrow is a homotopy equivalence. Now consider the diagram

$$\begin{array}{ccccc} \text{emb}_f(C_{n-1}, A_0 \text{ rel } S_{n-1}) & \longrightarrow & \text{emb}_f(C_{n-1}, A_0) & \longrightarrow & \text{emb}_f(S_{n-1}, A_0) \\ \downarrow & & \downarrow & & \downarrow \\ \text{emb}(C_{n-1}, A_0 \text{ rel } S_{n-1}) & \longrightarrow & \text{emb}(C_{n-1}, A_0) & \longrightarrow & \text{emb}(S_{n-1}, A_0) . \end{array}$$

The top row is a fibration by Corollary 3.4.3, and the bottom by the Palais-Cerf Restriction Theorem. The right vertical arrow was shown to be a homotopy equivalence by the previous diagram. For  $n = 2$ , both fibers are points, so the middle vertical arrow is a homotopy equivalence. But  $\text{emb}_f(C_{n-1}, A_0 \text{ rel } S_{n-1})$  can be identified with  $\text{emb}_f(C_{n-2}, A_0 - S_{n-1})$ , and similarly for the non-fiber-preserving spaces. So induction on  $n$  shows that the middle vertical arrow is a homotopy equivalence for any value of  $n$ .

To complete the proof, we use the diagram

$$\begin{array}{ccccc} \text{emb}_f(C_n, T \text{ rel } S_n) & \longrightarrow & \text{emb}_f(C_n, T) & \longrightarrow & \text{emb}_f(S_n, T) \\ \downarrow & & \downarrow & & \downarrow \\ \text{emb}(C_n, T \text{ rel } S_n) & \longrightarrow & \text{emb}(C_n, T) & \longrightarrow & \text{emb}(S_n, T) . \end{array}$$

The rows are fibrations, as in the previous diagram. The right-hand vertical arrow is the case  $n = 1$ , already proven, and the map between fibers can be identified with  $\text{emb}_f(C_{n-1}, A_0) \rightarrow \text{emb}(C_{n-1}, A_0)$ , which has been shown to be a homotopy equivalence for all  $n$ .

For the Klein bottle case, the proof is line-by-line the same in the case of the meridional fibering. For the longitudinal singular fibering,

the only difference is that rather than an annulus  $A$ , the first cut along  $S_n$  produces either one or two Möbius bands.  $\square$

LEMMA 4.8.2. *Let  $\Sigma$  be a compact 3-manifold with nonempty boundary and having a fixed Seifert fibering, and let  $F$  be a vertical 2-manifold properly embedded in  $\Sigma$ . Let  $\text{emb}_{\partial F}(F, \Sigma)$  be the connected component of the inclusion in the space of (proper) embeddings for which the image of  $\partial F$  is a union of fibers. Then  $\text{emb}_f(F, \Sigma) \rightarrow \text{emb}_{\partial F}(F, \Sigma)$  is a homotopy equivalence.*

To prove Lemma 4.8.2, we need a preliminary result.

LEMMA 4.8.3. *The following maps induced by restriction are fibrations.*

- (i)  $\text{emb}(F, \Sigma) \rightarrow \text{emb}(\partial F, \partial \Sigma)$
- (ii)  $\text{emb}_{\partial F}(F, \Sigma) \rightarrow \text{emb}_f(\partial F, \partial \Sigma)$
- (iii)  $\text{emb}_f(F, \Sigma) \rightarrow \text{emb}_f(\partial F, \partial \Sigma)$ .

PROOF. Parts (i) and (iii) are cases of Corollaries 3.8.3 and 3.8.4. Part (ii) follows from part (i) since  $\text{emb}_{\partial F}(F, \Sigma)$  is the inverse image of  $\text{emb}_f(\partial F, \partial \Sigma)$  under the fibration of part (i).  $\square$

PROOF OF LEMMA 4.8.2. First we use the following fibration from Theorem 3.6.4:

$$\text{Diff}_v(\Sigma \text{ rel } \partial \Sigma) \cap \text{diff}_f(\Sigma \text{ rel } \partial \Sigma) \rightarrow \text{diff}_f(\Sigma \text{ rel } \partial \Sigma) \rightarrow \text{diff}(\mathcal{O} \text{ rel } \partial \mathcal{O})$$

where  $\mathcal{O}$  is the quotient orbifold of  $\Sigma$  and as usual  $\text{Diff}_v$  indicates the diffeomorphisms that take each fiber to itself. The full orbifold diffeomorphism group of  $\mathcal{O}$  can be identified with a subspace consisting of path components of the diffeomorphism group of the 2-manifold  $B$  obtained by removing the cone points from  $\mathcal{O}$  (the subspace for which the permutation of punctures respects the local groups at the cone points). Since  $\partial B$  is nonempty,  $\text{diff}(B \text{ rel } \partial B)$  and therefore  $\text{diff}(\mathcal{O} \text{ rel } \partial \mathcal{O})$  are contractible. Since  $\pi_1(\text{diff}(\mathcal{O} \text{ rel } \partial \mathcal{O}))$  is trivial, the exact sequence of the fibration shows that  $\text{Diff}_v(\Sigma \text{ rel } \partial \Sigma) \cap \text{diff}_f(\Sigma \text{ rel } \partial \Sigma)$  is connected, so is equal to  $\text{diff}_v(\Sigma \text{ rel } \partial \Sigma)$ . It is not difficult to see that each component of  $\text{Diff}_v(\Sigma \text{ rel } \partial \Sigma)$  is contractible (see Lemma 3.9.4 for a similar argument), so we conclude that  $\text{diff}_f(\Sigma \text{ rel } \partial \Sigma)$  is contractible.

Next, consider the diagram

$$\begin{array}{ccccc} \text{Diff}_f(\Sigma \text{ rel } F \cup \partial \Sigma) \cap \text{diff}_f(\Sigma \text{ rel } \partial \Sigma) & \longrightarrow & \text{diff}_f(\Sigma \text{ rel } \partial \Sigma) & \longrightarrow & \text{emb}_f(F, \Sigma \text{ rel } \partial F) \\ & & \downarrow & & \downarrow \\ \text{Diff}(\Sigma \text{ rel } F \cup \partial \Sigma) \cap \text{diff}(\Sigma \text{ rel } \partial \Sigma) & \longrightarrow & \text{diff}(\Sigma \text{ rel } \partial \Sigma) & \longrightarrow & \text{emb}(F, \Sigma \text{ rel } \partial F) \end{array}$$

where the rows are fibrations by Corollaries 3.6.8 and 3.1.9. We have already shown that the components of  $\text{Diff}_f(\Sigma \text{ rel } \partial\Sigma)$  and (by cutting along  $F$ ) the components of  $\text{Diff}_f(\Sigma \text{ rel } F \cup \partial\Sigma)$  are contractible. By [22] (which, as noted in [22], extends to  $\text{Diff}$  using [24]), the components of  $\text{Diff}(\Sigma \text{ rel } \partial\Sigma)$  and  $\text{Diff}(\Sigma \text{ rel } F \cup \partial\Sigma)$  are contractible. Therefore to show that  $\text{emb}_f(F, \Sigma \text{ rel } \partial F) \rightarrow \text{emb}(F, \Sigma \text{ rel } \partial F)$  is a homotopy equivalence it is sufficient to show that  $\pi_0(\text{Diff}_f(\Sigma \text{ rel } F \cup \partial\Sigma) \cap \text{diff}_f(\Sigma \text{ rel } \partial\Sigma)) \rightarrow \pi_0(\text{Diff}(\Sigma \text{ rel } F \cup \partial\Sigma) \cap \text{diff}(\Sigma \text{ rel } \partial\Sigma))$  is bijective. It is surjective because every diffeomorphism of a Seifert-fibered 3-manifold which is fiber-preserving on the (non-empty) boundary is isotopic relative to the boundary to a fiber-preserving diffeomorphism (Lemma VI.19 of W. Jaco [37]). It is injective because fiber-preserving diffeomorphisms that are isotopic are isotopic through fiber-preserving diffeomorphisms (see Waldhausen [71]).

The proof is completed by the following diagram in which the rows are fibrations by parts (iii) and (ii) of Lemma 4.8.3, and we have verified that the left vertical arrow is a homotopy equivalence.

$$\begin{array}{ccccc}
 \text{emb}_f(F, \Sigma \text{ rel } \partial F) & \longrightarrow & \text{emb}_f(F, \Sigma) & \longrightarrow & \text{emb}_f(\partial F, \partial\Sigma) \\
 \downarrow & & \downarrow & & \downarrow = \\
 \text{emb}(F, \Sigma \text{ rel } \partial F) & \longrightarrow & \text{emb}_{\partial f}(F, \Sigma) & \longrightarrow & \text{emb}_f(\partial F, \partial\Sigma)
 \end{array}$$

□

*Step 5:* Complete the proof

We can now complete the proof of Theorem 4.5.1 by deforming the family  $F$  to a fiber-preserving family. Since (1) and (2'') are open conditions, we can cover  $D^k$  by convex  $k$ -cells  $B_j$ ,  $1 \leq j \leq r$ , having corresponding levels  $T_{u_j}$  for which (1) and (2'') hold throughout  $B_j$ . Also, we may slightly change the  $u$ -values, if necessary, to assume that the  $u_i$  are distinct. It is convenient to rename the  $B_j$  so that  $u_1 < u_2 < \dots < u_r$ , that is, so that the levels  $T_{u_j}$  sit farther away from  $K_0$  as  $j$  increases.

Choose a PL triangulation  $\Delta$  of  $D^k$  sufficiently fine so that each  $i$ -cell lies in at least one of the  $B_j$ . The deformation of  $F$  will take place sequentially over the  $i$ -skeleta of  $\Delta$ . It will never be necessary to change  $F$  at points of  $\partial D^k$ .

Suppose first that  $\tau$  is a 0-simplex of  $\Delta$ . Let  $j_1 < j_2 < \dots < j_s$  be the values of  $j$  for which  $\tau \subseteq B_j$ . By condition (2''), each intersection circle of  $K_\tau$  with each  $T_{j_q}$  is isotopic in  $T_{j_q}$  to a fiber of the Seifert fibering. We claim that they are also isotopic on  $K_\tau$  to an image of a fiber of  $K_0$  under  $F(\tau)$ . Since  $K_\tau$  is isotopic to  $K_0$  and the intersection

circles are two-sided in  $K_\tau$ , each intersection circle is isotopic in  $M$  to an  $a$ -loop or a  $b^2$ -loop in  $K_0$ . When  $m = 1$ ,  $b^2$  is the generic fiber of  $M$ , and  $a$  is not isotopic in  $M$  to  $b^2$  since  $a = b^{2n}$  and  $n \neq 1$ . When  $n = 1$ ,  $a$  is the fiber of  $M$ , and  $b^2$  is not isotopic to  $a$  since  $a^m = b^2$  and  $m > 1$ . So the isotopy from  $K_\tau$  to  $K_0$  carries the intersection loops to loops in  $K_0$  representing the fiber. But  $a$ -loops are nonseparating and  $b^2$ -loops are separating, so the intersection loops must be isotopic in  $K_\tau$  to the image of the fiber of  $K_0$  under  $F(\tau)$ .

We may deform the parameterized family near  $\tau$ , retaining transverse intersection with each  $T_{u_j}$  for which  $\tau \in B_j$ , so that the intersection circles of  $K_\tau$  with these  $T_{u_j}$  are fibers and images of fibers. To accomplish this, first change  $F(\tau)$  by an ambient isotopy of  $M$  that preserves levels and moves the intersection circles onto fibers in the  $T_{u_j}$ . Now, consider the inverse images of these circles in  $K_0$ . We have seen that there is an isotopy that moves them to be fibers, changing  $F(\tau)$  by this isotopy (and tapering it off in a small neighborhood of  $\tau$  in  $D^k$ ) we may assume that the intersection circles are fibers of  $K_\tau$  as well. Now, using Lemma 4.8.2 successively on the solid torus  $R_{u_s}$ , the product regions  $\overline{R_{u_{j-1}}} - \overline{R_{u_j}}$  for  $j = j_s, j_{s-1}, \dots, j_2$ , and the twisted I-bundle  $P_{u_{j_1}}$ , deform  $F(\tau)$  to be fiber-preserving. These isotopies preserve the levels  $T_{u_j}$  for which  $\tau \in B_j$ , so may be tapered off near  $\tau$  so as not to alter any other transversality conditions.

Inductively, suppose that  $F(t)$  is fiber-preserving for each  $t$  lying in any  $i$ -simplex of  $\Delta$ . Let  $\tau$  be an  $(i + 1)$ -simplex of  $\Delta$ . For each  $t \in \partial\tau$ ,  $F(t)$  is fiber-preserving. Consider a level  $T_{u_j}$  for which  $\tau \subset B_j$ . For each  $t \in \tau$ , the restriction of  $F(t)$  to the inverse image of  $T_{u_j}$  is a parameterized family of embeddings of a family of circles into  $T_{u_j}$ , which embeds to fibers at each  $t \in \partial\tau$ . By Lemma 4.8.1, there is a deformation of  $F|_\tau$ , relative to  $\partial\tau$ , which makes each  $K_t \cap T_{u_j}$  consist of fibers in  $T_{u_j}$ . We may select the deformation so as to move image points of each  $F(t)$  only very near  $T_{u_j}$ , and thereby not alter transversality with any other  $T_{u_\ell}$ . Now, the restriction of the  $F(t)^{-1}$  to the intersection circles is a family of embeddings of a collection of circles into  $K_0$ , which are fibers at points in  $\partial\tau$ . Using Lemma 4.8.1 we may alter  $F|_\tau$ , relative to  $\partial\tau$  and without changing the images  $F(t)(K_0)$ , so that the intersection circles are fibers of  $K_0$  as well. We repeat this for all  $\ell$  such that  $\tau \subset B_\ell$ . Using Lemma 4.8.2 as before, proceeding from  $R_{u_{j_s}}$  to  $P_{u_{j_1}}$ , deform  $F$  on  $\tau$ , relative to  $\partial\tau$ , to be fiber-preserving for all parameters in  $\tau$ . This completes the induction step and the proof of Theorem 4.5.1.

## CHAPTER 5

### Lens spaces

Recall that we always use the term *lens space* will mean a 3-dimensional lens space  $L(m, q)$  with  $m \geq 3$ . In addition, we always select  $q$  so that  $1 \leq q < m/2$ .

In this chapter, we will prove Theorem 1.2.3, the Smale Conjecture for Lens Spaces. The argument is regrettably quite lengthy. It uses a lot of combinatorial topology, but draws as well on some mathematics unfamiliar to many low-dimensional topologists. We have already seen some of that material in earlier chapters, but we will also have to use the Rubinstein-Scharlemann method, reviewed in Section 5.6, and some results from singularity theory, presented in Section 5.8.

The next section is a comprehensive outline of the entire proof. We hope that it will motivate the various technical complications that ensue.

#### 5.1. Outline of the proof

Some initial reductions, detailed in Section 5.2, reduce the Smale Conjecture for Lens Spaces to showing that the inclusion  $\text{diff}_f(L) \rightarrow \text{diff}(L)$  is an isomorphism on homotopy groups. Here,  $\text{diff}(L)$  is the connected component of the identity in  $\text{Diff}(L)$ , and  $\text{diff}_f(L)$  is the connected component of the identity in the group of diffeomorphisms that are fiber-preserving with respect to a Seifert fibering of  $L$  induced from the Hopf fibering of its universal cover,  $S^3$ . To simplify the exposition, most of the argument is devoted just to proving that  $\text{diff}_f(L) \rightarrow \text{diff}(L)$  is surjective on homotopy groups, that is, that a map from  $S^d$  to  $\text{diff}(L)$  is homotopic to a map into  $\text{diff}_f(L)$ . The injectivity is obtained in Section 5.13 by a combination of tricks and minor adaptations of the main program.

Of course, a major difficulty in working with elliptic 3-manifolds is their lack of incompressible surfaces. In their place, we use another structure which has a certain degree of essentiality, called a *sweepout*. This means a structure on  $L$  as a quotient of  $P \times I$ , where  $P$  is a torus, in which  $P \times \{0\}$  and  $P \times \{1\}$  are collapsed to core circles of the solid tori of a genus 1 Heegaard splitting of  $L$ . For  $0 < u \leq 1$ ,  $P \times \{t\}$  becomes a Heegaard torus in  $L$ , denoted by  $P_u$ , and called a *level*. The

sweepout is chosen so that each  $P_u$  is a union of fibers. Sweepouts are examined in Section 5.5.

Start with a parameterized family of diffeomorphisms  $f: L \times S^d \rightarrow L$ , and for  $u \in S^d$  denote by  $f_u$  the restriction of  $f$  to  $L \times \{u\}$ . The procedure that deforms  $f$  to make each  $f_u$  fiber-preserving has three major steps.

Step 1 (“finding good levels”) is to perturb  $f$  so that for each  $u$ , there is some pair  $(s, t)$  so that  $f_u(P_u)$  intersects  $P_t$  transversely, in a collection of circles each of which is either essential in both  $f_u(P_s)$  and  $P_t$  (a *biessential* intersection), or inessential in both (a *dis-cal* intersection), and at least one intersection circle is biessential. This pair is said to intersect in *good position*, and if none of the intersections is discal, in *very good position*. These concepts are developed in Section 5.4, after a preliminary examination of annuli in solid tori in Section 5.3.

To accomplish Step 1, the methodology of Rubinstein and Scharlemann in [58] is adapted. This is reviewed in Section 5.6. First, one perturbs  $f$  to be in “general position,” as defined in Section 5.8. The intersections of the  $f_u(P_s)$  and  $P_t$  are then sufficiently well-controlled to define a *graphic* in the square  $I^2$ . That is, the pairs  $(s, t)$  for which  $f_u(P_s)$  and  $P_t$  do not intersect transversely form a graph embedded in the square. The complementary regions of this graph in  $I^2$  are labeled according to a procedure in [58], and in Section 5.9 we show that the properties of general position salvage enough of the combinatorics of these labels developed in [58] to deduce that at least one of the complementary regions consists of pairs in good position.

Perhaps the hardest work of the proof, and certainly the part that takes us furthest from the usual confines of low-dimensional topology, is the verification that sufficient “general position” can be achieved. Since we use parameterized families, we must allow  $f_u(P_s)$  and  $P_t$  to have large numbers of tangencies, some of which may be of high order. It turns out that to make the combinatorics of [58] go through, we must achieve that at each parameter *there are at most finitely many pairs  $(s, t)$  where  $f_u(P_s)$  and  $P_t$  have multiple or high-order tangencies* (at least, for pairs not extremely close to the boundary of the square). To achieve the necessary degree of general position, we use results of a number of people, notably J. W. Bruce [8] and F. Sergeraert [63].

The need for this kind of general position is indicated in Section 5.7, where we construct a pair of sweepouts of  $S^2 \times S^1$  with all tangencies of Morse type, but having no pair of levels intersecting in good position. Although we have not constructed a similar example for an  $L(m, q)$ , we see no reason why one could not exist.



Step 2 (“from good to very good”) is to deform  $f$  to eliminate the discal intersections of  $f_u(P_s)$  and  $P_t$ , for certain pairs in good position that have been found in Step 1, so that they intersect in very good position. This is an application of Hatcher’s parameterization methods [22]. One must be careful here, since an isotopy that eliminates a discal intersection can also eliminate a biessential intersection, and if all biessential intersections were eliminated by the procedure, the resulting pair would no longer be in very good position. Lemma 5.10.2 ensures that not all biessential intersections will be eliminated.

Step 3 (“from very good to fiber-preserving”) is to use the pairs in very good position to deform the family so that each  $f_u$  is fiber-preserving. This is carried out in Sections 5.11 and 5.12. The basic idea is first to use the biessential intersections to deform the  $f_u$  so that  $f_u(P_s)$  actually equals  $P_t$  (for certain  $(s, t)$  pairs that originally intersected in good position), then use known results about the diffeomorphism groups of surfaces and Haken 3-manifolds to make the  $f_u$  fiber-preserving on  $P_s$  and then on its complementary solid tori. This process is technically complicated for two reasons. First, although a biessential intersection is essential in both tori, it can be contractible in one of the complementary solid tori of  $P_t$ , and  $f_u(P_s)$  can meet that complementary solid torus in annuli that are not parallel into  $P_t$ . So one may be able to push the annuli out from only one side of  $P_t$ . Secondly, the fitting together of these isotopies requires one to work with not just one level but many levels at a single parameter.

Two natural questions are whether Bonahon’s original method for determining the mapping class group  $\pi_0(\text{Diff}(L))$  [6] can be adapted to the parameterized setting, and whether our methodology can be used to recover his results. Concerning the first question, we have had no success with this approach, as we see no way to perturb the family to the point where the method can be started at each parameter. For the second, the answer is yes. In fact, the key geometric step of [6] is the isotopy uniqueness of genus-one Heegaard surfaces in  $L$ , which was already reproven in Rubinstein and Scharlemann’s original work [58, Corollary 6.3].

## 5.2. Reductions

In this section, we carry out some initial reductions. The Conjecture will be reduced to a purely topological problem of deforming parameterized families of diffeomorphisms to families of diffeomorphisms that preserve a certain Seifert fibering of  $L$ .

By Theorem 1.2.1, it is sufficient to prove that  $\text{isom}(L) \rightarrow \text{diff}(L)$  is a homotopy equivalence. And we have seen that this follows once we prove that  $\text{isom}(L) \rightarrow \text{diff}(L)$  is a homotopy equivalence.

Section 1.4 of [46] gives a certain way to embed  $\pi_1(L)$  into  $\mathrm{SO}(4)$  so that its action on  $S^3$  is fiber-preserving for the fibers of the Hopf bundle structure of  $S^3$ . Consequently, this bundle structure descends to a Seifert fibering of  $L$ , which we call the *Hopf fibering* of  $L$ . If  $q = 1$ , this Hopf fibering is actually an  $S^1$ -bundle structure, while if  $q > 1$ , it has two exceptional fibers with invariants of the form  $(k, q_1), (k, q_2)$  where  $k = m/\mathrm{gcd}(q-1, m)$  (see Table 4 of [46]). We will always use the Hopf fibering as the Seifert-fibered structure of  $L$ .

Theorem 2.1 of [46] shows that (since  $m > 2$ ) every orientation-preserving isometry of  $L$  preserves the Hopf fibering on  $L$ . In particular,  $\mathrm{isom}(L) \subset \mathrm{diff}_f(L)$ , so there are inclusions

$$\mathrm{isom}(L) \rightarrow \mathrm{diff}_f(L) \rightarrow \mathrm{diff}(L) .$$

**THEOREM 5.2.1.** *The inclusion  $\mathrm{isom}(L) \rightarrow \mathrm{diff}_f(L)$  is a homotopy equivalence.*

**PROOF.** The argument is similar to the latter part of the proof of Theorem 4.5.2, so we only give a sketch. There is a diagram

$$\begin{array}{ccccc} S^1 & \longrightarrow & \mathrm{isom}(L) & \longrightarrow & \mathrm{isom}(L_0) \\ \downarrow & & \downarrow & & \downarrow \\ \mathrm{vert}(L) & \longrightarrow & \mathrm{diff}_f(L) & \longrightarrow & \mathrm{diff}_{orb}(L_0) \end{array}$$

where  $L_0$  is the quotient orbifold and  $\mathrm{diff}_{orb}(L_0)$  is the group of orbifold diffeomorphisms of  $L_0$ , and  $\mathrm{vert}(L)$  is the group of vertical diffeomorphisms. The first row is a fibration, in fact an  $S^1$ -bundle, and the second row is a fibration by Theorem 3.6.4. The vertical arrows are inclusions. When  $q = 1$ ,  $L_0$  is the 2-sphere and the right-hand vertical arrow is the inclusion of  $\mathrm{SO}(3)$  into  $\mathrm{diff}(S^2)$ , which is a homotopy equivalence by [64]. When  $q > 1$ ,  $L_0$  is a 2-sphere with two cone points,  $\mathrm{isom}(L_0)$  is homeomorphic to  $S^1$ , and  $\mathrm{diff}_{orb}(L_0)$  is essentially the connected component of the identity in the diffeomorphism group of the annulus. Again the right-hand vertical arrow is a homotopy equivalence. The left-hand vertical arrow is a homotopy equivalence in both cases, so the middle arrow is as well.  $\square$

Theorem 5.2.1 reduces the Smale Conjecture for Lens Spaces to proving that the inclusion  $\mathrm{diff}_f(L) \rightarrow \mathrm{diff}(L)$  is a homotopy equivalence. For this it is sufficient to prove that for all  $d \geq 1$ , any map  $f: (D^d, S^{d-1}) \rightarrow (\mathrm{diff}(L), \mathrm{diff}_f(L))$  is homotopic, through maps taking  $S^{d-1}$  to  $\mathrm{diff}_f(L)$ , to a map from  $D^d$  into  $\mathrm{diff}_f(L)$ . To simplify the exposition, we work until the final section with a map  $f: S^d \rightarrow \mathrm{diff}(L)$  and show that it is homotopic to a map into  $\mathrm{diff}_f(L)$ . In the final section,

we give a trick that enables the entire procedure to be adapted to maps  $f: (D^d, S^{d-1}) \rightarrow (\text{diff}(L), \text{diff}_f(L))$ , completing the proof.

### 5.3. Annuli in solid tori

Annuli in solid tori will appear frequently in our work. Incompressible annuli present little difficulty, but we will also need to examine compressible annuli, whose behavior is more complicated. In this section, we provide some basic definitions and lemmas.

A loop  $\alpha$  in a solid torus  $V$  is called a *longitude* if its homotopy class is a generator of the infinite cyclic group  $\pi_1(V)$ . If in addition there is a product structure  $V = S^1 \times D^2$  for which  $\alpha = S^1 \times \{0\}$ , then  $\alpha$  is called a *core circle* of  $V$ . A subset of a solid torus  $V$  is called a *core region* when it contains a core circle of  $V$ . An embedded circle in  $\partial V$  which is essential in  $\partial V$  and contractible in  $V$  is called a *meridian* of  $V$ ; a properly embedded disk in  $V$  whose boundary is a meridian is called a *meridian disk* of  $V$ .

Annuli in solid tori will always be assumed to be properly embedded, which for us includes the property of being transverse to the boundary, unless they are actually contained in the boundary. The next three results are elementary topological facts, and we do not include proofs.

**PROPOSITION 5.3.1.** *Let  $A$  be a boundary-parallel annulus in a solid torus  $V$ , which separates  $V$  into  $V_0$  and  $V_1$ , and for  $i = 0, 1$ , let  $A_i = V_i \cap \partial V$ . Then  $A$  is parallel to  $A_i$  if and only if  $V_{1-i}$  is a core region.*

**PROPOSITION 5.3.2.** *Let  $A$  be a properly embedded annulus in a solid torus  $V$ , which separates  $V$  into  $V_0$  and  $V_1$ , and let  $A_i = V_i \cap \partial V$ . The following are equivalent:*

- (1)  $A$  contains a longitude of  $V$ .
- (2)  $A$  contains a core circle of  $V$ .
- (3)  $A$  is parallel to both  $A_0$  and  $A_1$ .
- (4) Both  $V_0$  and  $V_1$  contain longitudes of  $V$ .
- (5) Both  $V_0$  and  $V_1$  are core regions of  $V$ .

An annulus satisfying the conditions in Proposition 5.3.2 is said to be *longitudinal*. A longitudinal annulus must be incompressible.

**PROPOSITION 5.3.3.** *Let  $V$  be a solid torus and let  $\cup A_i$  be a union of disjoint boundary-parallel annuli in  $V$ . Let  $C$  be a core circle of  $V$  that is disjoint from  $\cup A_i$ . For each  $A_i$ , let  $V_i$  be the closure of the complementary component of  $A_i$  that does not contain  $C$ , and let  $B_i = V_i \cap \partial V$ . Then  $A_i$  is parallel to  $B_i$ . Furthermore, either*

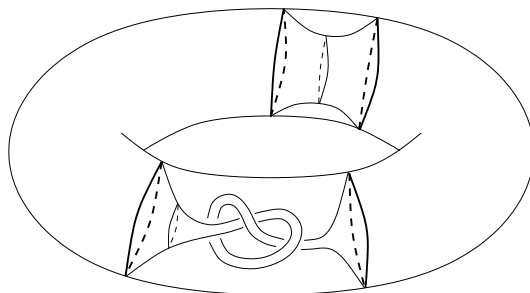

FIGURE 5.1. Meridional annuli in a solid torus.

- (1) *no  $A_i$  is longitudinal, and exactly one component of  $V - \cup A_i$  is a core region, or*
- (2) *every  $A_i$  is longitudinal, and every component of  $V - \cup A_i$  is a core region.*

There are various kinds of compressible annuli in solid tori. For example, there are boundaries of regular neighborhoods of properly embedded arcs, possibly knotted. Also, there are annuli with one boundary circle a meridian and the other a contractible circle in the boundary torus. When both boundary circles are meridians, we call the annulus *meridional*. As shown in Figure 5.1, meridional annuli are not necessarily boundary-parallel.

Although meridional annuli need not be boundary-parallel, they behave homologically as though they were, and as a consequence any family of meridional annuli misses some longitude.

LEMMA 5.3.4. *Let  $A_1, \dots, A_n$  be disjoint meridional annuli in a solid torus  $V$ . Then:*

- (1) *Each  $A_i$  separates  $V$  into two components,  $V_{i,0}$  and  $V_{i,1}$ , for which  $A_i$  is incompressible in  $V_{i,0}$  and compressible in  $V_{i,1}$ .*
- (2)  *$V_{i,1}$  contains a meridian disk of  $V$ .*
- (3)  *$\pi_1(V_{i,0}) \rightarrow \pi_1(V)$  is the zero homomorphism.*
- (4) *The intersection of the  $V_{i,1}$  is the unique component of the complement of  $\cup A_i$  that contains a longitude of  $V$ .*

PROOF. For each  $i$ , every loop in  $V$  has even algebraic intersection with  $A_i$ , since every loop in  $\partial V$  does, so  $A_i$  separates  $V$ . Since  $A_i$  is not incompressible, it must be compressible in one of its complementary components,  $V_{i,1}$ , and since  $V$  is irreducible,  $A_i$  must be incompressible in the other complementary component,  $V_{i,0}$ .

Notice that  $V_{i,1}$  must contain a meridian disk of  $V$ . Indeed, if  $K$  is the union of  $A_i$  with a compressing disk in  $V_{i,1}$ , then two of the

components of the frontier of a regular neighborhood of  $K$  in  $V$  are meridian disks of  $V_{i,1}$ . Consequently,  $\pi_1(V_{i,0}) \rightarrow \pi_1(V)$  is the zero homomorphism. The Mayer-Vietoris sequence shows that  $H_1(A_i) \rightarrow H_1(V_{i,0})$  and  $H_1(V_{i,1}) \rightarrow H_1(V)$  are isomorphisms.

Let  $V_1$  be the intersection of the  $V_{i,1}$ , and let  $V_0$  be the union of the  $V_{i,0}$ . The Mayer-Vietoris sequence shows that  $V_1$  is connected, and that  $H_1(V_1) \rightarrow H_1(V)$  is an isomorphism, so  $V_1$  contains a longitude of  $V$ . For any  $i, j$ , either  $V_{i,1} \subseteq V_{j,1}$  or  $V_{j,1} \subseteq V_{i,1}$ , since otherwise  $H_1(V_{i,1}) \rightarrow H_1(V_{j,0}) \rightarrow H_1(V)$  would be the zero homomorphism. Therefore the intersection  $V_1 = \cap V_{i,1}$  is equal to some  $V_{k,1}$ , and in particular it contains a longitude of  $V$ . No other complementary component of  $\cup A_i$  contains a longitude, since each such component lies in  $V_{k,0}$ , all of whose loops are contractible in  $V$ .  $\square$

#### 5.4. Heegaard tori in very good position

A *Heegaard torus* in a lens space  $L$  is a torus that separates  $L$  into two solid tori. In this section we will develop some properties of Heegaard tori. Also, we introduce the concepts of discal and biessential intersection circles, good position, and very good position, which will be used extensively in later sections.

When  $P$  is a Heegaard torus bounding solid tori  $V$  and  $W$ , and  $Q$  is a Heegaard torus contained in the interior of  $V$ ,  $Q$  need not be parallel to  $\partial V$ . For example, start with a core circle in  $V$ , move a small portion of it to  $\partial V$ , then pass it across a meridian disk of  $W$  and back into  $V$ . This moves the core circle to its band-connected sum in  $V$  with an  $(m, q)$ -curve in  $\partial V$ . By varying the choice of band— for example, by twisting it or tying knots in it— and by iterating this construction, one can construct complicated knotted circles in  $V$  which are isotopic in  $L$  to a core circle of  $V$ . The boundary of a regular neighborhood of such a circle is a Heegaard torus of  $L$ . But here is one restriction on Heegaard tori

**PROPOSITION 5.4.1.** *Let  $P$  be a Heegaard torus in a lens space  $L$ , bounding solid tori  $V$  and  $W$ . If a loop  $\ell$  embedded in  $P$  is a core circle for a solid torus of some genus-1 Heegaard splitting of  $L$ , then  $\ell$  is a longitude for either  $V$  or  $W$ .*

**PROOF.** Since  $L$  is not simply-connected,  $\ell$  is not a meridian for either  $V$  or  $W$ , consequently  $\pi_1(\ell) \rightarrow \pi_1(V)$  and  $\pi_1(\ell) \rightarrow \pi_1(W)$  are injective. So  $P - \ell$  is an open annulus separating  $L - \ell$ , making  $\pi_1(L - \ell)$  a free product with amalgamation  $\mathbb{Z} *_\mathbb{Z} \mathbb{Z}$ . Since  $\ell$  is a core circle,  $\pi_1(L - \ell)$  is infinite cyclic, so at least one of the inclusions of the amalgamating subgroup to the infinite cyclic factors is surjective.  $\square$

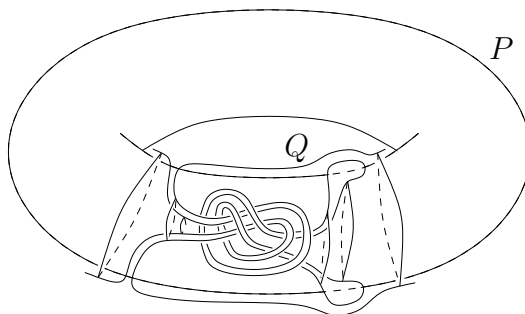

FIGURE 5.2. Heegaard tori in very good position with non-boundary-parallel meridional annuli.

Let  $F_1$  and  $F_2$  be transversely intersecting embedded surfaces in the interior of a 3-manifold  $M$ . A component of  $F_1 \cap F_2$  is called *discal* when it is contractible in both  $F_1$  and  $F_2$ , and *biessential* when it is essential in both. We say that  $F_1$  and  $F_2$  are *in good position* when every component of their intersection is either discal or biessential, and at least one is biessential, and we say that they are *in very good position* when they are in good position and every component of their intersection is biessential.

Later, we will go to considerable effort to obtain pairs of Heegaard tori for lens spaces that intersect in very good position. Even then, the configuration can be complicated. Consider a Heegaard torus  $P$  bounding solid tori  $V$  and  $W$ , and another Heegaard torus  $Q$  that meets  $P$  in very good position. When the intersection circles are not meridians for either  $V$  or  $W$ , the components of  $Q \cap V$  and  $Q \cap W$  are annuli that are incompressible in  $V$  and  $W$ , and must be as described in Proposition 5.3.3. But if the intersection circles are meridians for one of the solid tori, say  $V$ , then  $Q \cap V$  consists of meridional annuli, and as shown in Figure 5.2, they need not be boundary-parallel. To obtain that configuration, one starts with a torus  $Q$  parallel to  $P$  and outside  $P$ , and changes  $Q$  by an isotopy that moves a meridian  $c$  of  $Q$  in a regular neighborhood of a meridian disk of  $P$ . First,  $c$  passes across a meridian in  $P$ , then shrinks down to a small circle which traces around a knot. Then, it expands out to another meridian in  $P$  and pushes across. The resulting torus meets  $P$  in four circles which are meridians for  $V$ , and meets  $V$  in two annuli, both isotopic to the non-boundary-parallel annulus in Figure 5.1. The next lemma gives a small but important restriction on meridional annuli of  $Q \cap V$ .

LEMMA 5.4.2. *Let  $P$  be a Heegaard torus which separates a lens space into two solid tori  $V$  and  $W$ . Let  $Q$  be another Heegaard torus whose intersection with  $V$  consists of a single meridional annulus  $A$ . Then  $A$  is boundary-parallel in  $V$ .*

PROOF. From Lemma 5.3.4,  $A$  separates  $V$  into two components  $V_0$  and  $V_1$ , such that  $A$  is compressible in  $V_1$  and  $V_1$  contains a longitude of  $V$ . Suppose that  $A$  is not boundary-parallel in  $V$ .

Let  $A_0 = V_0 \cap \partial V$ . Of the two solid tori in  $L$  bounded by  $Q$ , let  $X$  be the one that contains  $A_0$ , and let  $Y$  be the other one. Since  $Q \cap V$  consists only of  $A$ ,  $Y$  contains  $V_1$ , and in particular contains a compressing disk for  $A$  in  $V_1$  and a longitude for  $V$ .

Suppose that  $A_0$  were incompressible in  $X$ . Since  $A_0$  is not parallel to  $A$ , it would be parallel to  $\overline{\partial X - A}$ . So  $V_0$  would contain a core circle of  $X$ . Since  $\pi_1(V_0) \rightarrow \pi_1(V)$  is the zero homomorphism, this implies that  $L$  is simply-connected, a contradiction. So  $A_0$  is compressible in  $X$ . A compressing disk for  $A_0$  in  $X$  is part of a 2-sphere that meets  $Y$  only in a compressing disk of  $A$  in  $V_1$ . This 2-sphere has algebraic intersection  $\pm 1$  with the longitude of  $V$  in  $V_1$ , contradicting the irreducibility of  $L$ .  $\square$

Regarding  $D^2$  as the unit disk in the plane, for  $0 < r < 1$  let  $rD^2$  denote  $\{(x, y) \mid x^2 + y^2 \leq r^2\}$ . A solid torus  $X$  embedded in a solid torus  $V$  is called *concentric in  $V$*  if there is some product structure  $V = D^2 \times S^1$  such that  $X = rD^2 \times S^1$ . Equivalently,  $X$  is in the interior of  $V$  and some (hence every) core circle of  $X$  is a core circle of  $V$ .

The next lemma shows how we will use Heegaard tori that meet in very good position.

LEMMA 5.4.3. *Let  $P$  be a Heegaard torus which separates a lens space into two solid tori  $V$  and  $W$ . Let  $Q$  be another Heegaard torus, that meets  $P$  in very good position, and assume that the annuli of  $Q \cap V$  are incompressible in  $V$ . Then at least one component  $C$  of  $V - (Q \cap V)$  satisfies both of the following:*

- (1)  $C$  is a core region for  $V$ .
- (2) Suppose that  $Q$  is moved by isotopy to a torus  $Q_1$  in  $W$ , by pushing the annuli of  $Q \cap V$  one-by-one out of  $V$  using isotopies that move them across regions of  $V - C$ , and let  $X$  be the solid torus bounded by  $Q_1$  that contains  $V$ . Then  $V$  is concentric in  $X$ .
- (3) After all but one of the annuli have been pushed out of  $V$ , the image  $Q_0$  of  $Q$  is isotopic to  $P$  relative to  $Q_0 \cap P$ .

PROOF. Assume first that  $Q \cap V$  has only one component  $A$ . Then  $\partial A$  separates  $P$  into two annuli,  $A_1$  and  $A_2$ . Since  $A$  is incompressible in  $V$ , it is parallel in  $V$  to at least one of the  $A_i$ , say  $A_1$ . Let  $A' = Q \cap W$ .

If  $A'$  is longitudinal, then  $A'$  is parallel in  $W$  to  $A_2$ . So pushing  $A$  across  $A_1$  moves  $Q$  to a torus in  $W$  parallel to  $P$ , and the lemma holds, with  $C$  being the region between  $A$  and  $A_2$ . An isotopy from  $Q$  to  $P$  can be carried out relative to  $Q \cap P$ , giving the last statement of the lemma. Suppose that  $A'$  is not longitudinal. If  $A'$  is incompressible, then it is boundary parallel in  $W$ . If  $A'$  is not incompressible, then since  $P$  and  $Q$  meet in very good position,  $A'$  is meridional, and by Lemma 5.4.2 it is again boundary-parallel in  $W$ . If  $A'$  is parallel to  $A_2$ , then we are finished as before. If  $A'$  is parallel to  $A_1$ , but not to  $A_2$ , then there is an isotopy moving  $Q$  to a regular neighborhood of a core circle of  $A_1$ . By Proposition 5.4.1,  $A$  is longitudinal, so must also be parallel in  $V$  to  $A_2$ . In this case, we take  $C$  to be the region between  $A$  and  $A_1$ .

Suppose now that  $Q \cap V$  and hence also  $Q \cap W$  consist of  $n$  annuli, where  $n > 1$ . By isotopies pushing outermost annuli in  $V$  across  $P$ , we obtain  $Q_0$  with  $Q_0 \cap V$  consisting of one annulus  $A$ . At least one of its complementary components, call it  $C$ , satisfies the lemma. Let  $Z$  be the union of the regions across which the  $n - 1$  annuli were pushed. Since  $C$  is a core region,  $C \cap (V - Z)$  is also a core region (since a core circle of  $V$  in  $C$  can be moved, by the reverse of the pushout isotopies, to a core circle of  $V$  in  $C \cap (V - Z)$ ). So  $C \cap (V - Z)$  satisfies the conclusion of the lemma.  $\square$

Here is a first consequence of Lemma 5.4.3.

**COROLLARY 5.4.4.** *Let  $P$  be a Heegaard torus which separates a lens space into two solid tori  $V$  and  $W$ , and let  $Q$  be another Heegaard torus separating it into  $X$  and  $Y$ . Assume that  $Q$  meets  $P$  in very good position. If the circles of  $P \cap Q$  are meridians in  $X$  or in  $Y$  (respectively, in  $X$  and in  $Y$ ), then they are meridians in  $V$  or in  $W$  (respectively, in  $V$  and in  $W$ ). An analogous assertion holds for longitudes.*

**PROOF.** We may choose notation so that the annuli of  $Q \cap V$  are incompressible in  $V$ . Use Lemma 5.4.3 to move  $Q$  out of  $V$ . After all but one annulus has been pushed out, the image  $Q_0$  of  $Q$  is isotopic to  $P$  relative to  $Q_0 \cap P$ . That is, the original  $Q$  is isotopic to  $P$  by an isotopy relative to  $Q_0 \cap P$ . If the circles of  $Q \cap P$  were originally meridians of  $X$  or  $Y$ , then in particular those of  $Q_0 \cap P$  are meridians of  $X$  or  $Y$  after the isotopy, that is, of  $V$  or  $W$ . The “and” assertion and the case of longitudes are similar.  $\square$



### 5.5. Sweepouts, and levels in very good position

In this section we will define sweepouts and related structures. Also, we will prove an important technical lemma concerning pairs of sweepouts having levels that meet in very good position.

By a *sweepout* of a closed orientable 3-manifold, we mean a smooth map  $\tau: P \times [0, 1] \rightarrow M$ , where  $P$  is a closed orientable surface, such that

- (1)  $T_0 = \tau(P \times \{0\})$  and  $T_1 = \tau(P \times \{1\})$  are disjoint graphs with each vertex of valence 3.
- (2) Each  $T_i$  is a union of a collection of smoothly embedded arcs and circles in  $M$ .
- (3)  $\tau|_{P \times (0,1)}: P \times (0, 1) \rightarrow M$  is a diffeomorphism onto  $M - (T_0 \cup T_1)$ .
- (4) Near  $P \times \partial I$ ,  $\tau$  gives a mapping cylinder neighborhood of  $T_0 \cup T_1$ .

Associated to any  $t$  with  $0 < t < 1$ , there is a Heegaard splitting  $M = V_t \cup W_t$ , where  $V_t = \tau(P \times [0, t])$  and  $W_t = \tau(P \times [t, 1])$ . For each  $t$ ,  $T_0$  is a deformation retract of  $V_t$  and  $T_1$  is a deformation retract of  $W_t$ . We denote  $\tau(P \times \{t\})$  by  $P_t$ , and call it a *level* of  $\tau$ . Also, for  $0 < s < t < 1$  we denote  $\tau(P \times [s, t])$  by  $R(s, t)$ . Note that any genus-1 Heegaard splitting of  $L$  provides sweepouts with  $T_0$  and  $T_1$  as core circles of the two solid tori, and the Heegaard torus as one of the levels.

A sweepout  $\tau: P \times [0, 1] \rightarrow M$  induces a continuous projection function  $\pi: M \rightarrow [0, 1]$  by the rule  $\pi(\tau(x, t)) = t$ . By composing this with a smooth bijection from  $[0, 1]$  to  $[0, 1]$  all of whose derivatives vanish at 0 and at 1, we may reparameterize  $\tau$  to ensure that  $\pi$  is a smooth map. We always assume that  $\tau$  has been selected to have this property.

By a *spine* for a closed connected surface  $P$ , we mean a 1-dimensional cell complex in  $P$  whose complement consists of open disks.

The next lemma gives very strong restrictions on levels of two different sweepouts of a lens space that intersect in very good position.

LEMMA 5.5.1. *Let  $L$  be a lens space. Let  $\tau: T \times [0, 1] \rightarrow L$  be a sweepout as above, where  $T$  is a torus. Let  $\sigma: T \times [0, 1] \rightarrow L$  be another sweepout, with levels  $Q_s = \sigma(T \times \{s\})$ . Suppose that for  $t_1 < t_2$ ,  $s_1 \neq s_2$ , and  $i = 1, 2$ ,  $Q_{s_i}$  and  $P_{t_i}$  intersect in very good position, and that  $Q_{s_1}$  has no discal intersections with  $P_{t_2}$ . If  $Q_{s_1}$  has nonempty intersection with  $P_{t_2}$ , then either*

- (1) *every intersection circle of  $Q_{s_1}$  with  $P_{t_2}$  is biessential, and consequently  $Q_{s_1} \cap R(t_1, t_2)$  contains an annulus with one boundary circle essential in  $P_{t_1}$  and the other essential in  $P_{t_2}$ , or*

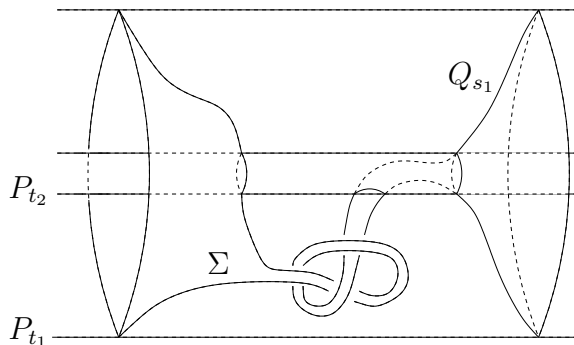

FIGURE 5.3. Case (2) of Lemma 5.5.1

- (2) for  $i = 1, 2$ ,  $Q_{s_i} \cap P_{t_i}$  consists of meridians of  $W_{t_i}$ , and  $Q_{s_1} \cap R(t_1, t_2)$  contains a surface  $\Sigma$  which is a homology from a circle of  $Q_{s_1} \cap P_{t_1}$  to a union of circles in  $P_{t_2}$ .

Figure 5.3 illustrates case (2) of Lemma 5.5.1.

We mention that to apply Lemma 5.5.1 when  $t_1 > t_2$ , we interchange the roles of  $V_{t_i}$  and  $W_{t_i}$ . The intersection circles in case (2) are then meridians of the  $V_{t_i}$  rather than the  $W_{t_i}$ .

PROOF OF LEMMA 5.5.1. Assume for now that the circles of  $Q_{s_2} \cap P_{t_2}$  are not meridians of  $W_{t_2}$ .

We first rule out the possibility that there exists a circle of  $Q_{s_1} \cap P_{t_2}$  that is inessential in  $Q_{s_1}$ . If so, there would be a circle  $C$  of  $Q_{s_1} \cap P_{t_2}$ , bounding a disk  $D$  in  $Q_{s_1}$  with interior disjoint from  $P_{t_2}$ . Since  $Q_{s_1}$  and  $P_{t_2}$  have no discal intersections,  $C$  is essential in  $P_{t_2}$ , so  $D$  is a meridian disk for  $V_{t_2}$  or  $W_{t_2}$ . It cannot be a meridian disk for  $V_{t_2}$ , for then some circle of  $D \cap P_{t_1}$  would be a meridian of  $V_{t_1}$ , contradicting the fact that  $Q_{s_1}$  and  $P_{t_1}$  meet in very good position. But  $D$  cannot be a meridian disk for  $W_{t_2}$ , since  $D$  is disjoint from  $Q_{s_2}$  and the circles of  $Q_{s_2} \cap P_{t_2}$  are not meridians of  $W_{t_2}$ .

We now rule out the possibility that there exists a circle of  $Q_{s_1} \cap P_{t_2}$  that is essential in  $Q_{s_1}$  and inessential in  $P_{t_2}$ . There is at least one biessential intersection circle of  $Q_{s_1}$  with  $P_{t_1}$ , hence also an annulus  $A$  in  $Q_{s_1}$  with one boundary circle inessential in  $P_{t_2}$  and the other essential in either  $P_{t_1}$  or  $P_{t_2}$ , with no intersection circle of the interior of  $A$  with  $P_{t_1} \cup P_{t_2}$  essential in  $A$ . The interior of  $A$  must be disjoint from  $P_{t_1}$ , since  $Q_{s_1}$  meets  $P_{t_1}$  in very good position. It must also be disjoint from  $P_{t_2}$ , by the previous paragraph. So, since  $A$  has at least one boundary circle in  $P_{t_2}$ , it is properly embedded either in  $R(t_1, t_2)$  or in  $W_{t_2}$ . It cannot be in  $R(t_1, t_2)$ , since it has one boundary circle inessential in  $P_{t_2}$  and the other essential in  $P_{t_1} \cup P_{t_2}$ . So  $A$  is in  $W_{t_2}$ ,

and since one boundary circle is inessential in  $P_{t_2}$ , the other must be a meridian, contradicting the assumption that no circle of  $Q_{s_2} \cap P_{t_2}$  is a meridian of  $W_{t_2}$ . Thus conclusion (1) holds when circles of  $Q_{s_2} \cap P_{t_2}$  are not meridians of  $W_{t_2}$ .

Assume now that the circles of  $Q_{s_2} \cap P_{t_2}$  are meridians of  $W_{t_2}$ . We will achieve conclusion (2).

Suppose first that some circle of  $Q_{s_1} \cap P_{t_2}$  is essential in  $Q_{s_1}$ . Then there is an annulus  $A$  in  $Q_{s_1}$  with one boundary circle essential in  $P_{t_1}$ , the other essential in  $P_{t_2}$ , and all intersections of the interior of  $A$  with  $P_{t_1} \cup P_{t_2}$  inessential in  $A$ . Since  $Q_{s_1}$  meets  $P_{t_1}$  in very good position, the interior of  $A$  must be disjoint from  $P_{t_1}$ . So  $A \cap R(t_1, t_2)$  contains a planar surface  $\Sigma$  with one boundary component a circle of  $Q_{s_1} \cap P_{t_1}$  and the other boundary components circles in  $P_{t_2}$  which are meridians in  $W_{t_2}$ , giving the conclusion (2) of the lemma.

Suppose now that every circle of  $Q_{s_1} \cap P_{t_2}$  is contractible in  $Q_{s_1}$ . We will show that this case is impossible. An intersection circle innermost on  $Q_{s_1}$  bounds a disk  $D$  in  $Q_{s_1}$  which is a meridian disk for  $W_{t_2}$ , since  $\partial D$  is essential in  $P_{t_2}$  and disjoint from  $Q_{s_2} \cap P_{t_2}$ . Now, use Lemma 5.4.3 to push  $Q_{s_2} \cap V_{t_2}$  out of  $V_{t_2}$  by an ambient isotopy of  $L$ . Suppose for contradiction that one of these pushouts, say, pushing an annulus  $A_0$  in  $Q_{s_2}$  across an annulus in  $P_{t_2}$ , also eliminates a circle of  $Q_{s_1} \cap P_{t_1}$ . Let  $Z$  be the region of parallelism across which  $A_0$  is pushed. Since  $Z$  contains an essential loop of  $Q_{s_1}$ , and each circle of  $Q_{s_1} \cap P_{t_2}$  is contractible in  $Q_{s_1}$ ,  $Z$  contains a spine of  $Q_{s_1}$ . This spine is isotopic in  $Z$  into a neighborhood of a boundary circle of  $A_0$ . Since this boundary circle is a meridian of  $W_{t_2}$ , every circle in the spine is contractible in  $L$ . This contradicts the fact that  $Q_{s_1}$  is a Heegaard torus. So the pushouts do not eliminate intersections of  $Q_{s_1}$  with  $P_{t_1}$ , and after the pushouts are completed, the image of  $Q_{s_1}$  still meets  $P_{t_1}$ .

During the pushouts, some of the intersection circles of  $Q_{s_1}$  with  $P_{t_2}$  may disappear, but not all of them, since the pushouts only move points into  $W_{t_2}$ . So after the pushouts, there is a circle of  $Q_{s_1} \cap P_{t_2}$  that bounds an innermost disk in  $Q_{s_1}$  (since all the original intersection circles of  $Q_{s_1}$  with  $P_{t_2}$  bound disks in  $Q_{s_1}$ , and the new intersection circles are a subset of the old ones). Since the boundary of this disk is a meridian of  $W_{t_2}$ , the disk it bounds in  $Q_{s_1}$  must be a meridian disk of  $W_{t_2}$ . The image of  $Q_{s_2}$  lies in  $W_{t_2}$  and misses this meridian disk, contradicting the fact that  $Q_{s_2}$  is a Heegaard torus.  $\square$

### 5.6. The Rubinstein-Scharlemann graphic

The purpose of this section is to present a number of definitions, and to sketch the proof of Theorem 5.6.1 below, originally from [58]. It requires the hypothesis that two sweepouts meet in general position in a strong sense that we call Morse general position. In Section 5.9, this proof will be adapted to the weaker concept of general position developed in Section 5.8.

Consider a smooth function  $f: (\mathbb{R}^2, 0) \rightarrow (\mathbb{R}, 0)$ . A critical point of  $f$  is *stable* when it is locally equivalent under smooth change of coordinates of the domain and range to  $f(x, y) = x^2 + y^2$  or  $f(x, y) = x^2 - y^2$ . The first type is called a *center*, and the second a *saddle*. An unstable critical point is called a *birth-death* point if it is locally  $f(x, y) = x^2 + y^3$ .

Let  $\tau: P \times [0, 1] \rightarrow M$  be a sweepout as in Section 5.5. As in that section, we denote  $\tau(P \times \{0, 1\})$  by  $T$ ,  $\tau(P \times \{t\})$  by  $P_t$ ,  $\tau(P \times [0, t])$  by  $V_t$ , and  $\tau(P \times [t, 1])$  by  $W_t$ . For a second sweepout  $\sigma: Q \times [0, 1] \rightarrow M$ , we denote  $\sigma(Q \times \{0, 1\})$  by  $S$ ,  $\sigma(Q \times \{s\})$  by  $Q_s$ ,  $\sigma(Q \times [0, s])$  by  $X_s$ , and  $\sigma(Q \times [s, 1])$  by  $Y_s$ . We call  $Q_s$  a  $\sigma$ -level and  $P_t$  a  $\tau$ -level.

A tangency of  $Q_s$  and  $P_t$  at a point  $w$  is said to be *of Morse type* at  $w$  if in some local  $xyz$ -coordinates with origin at  $w$ ,  $P_t$  is the  $xy$ -plane and  $Q_s$  is the graph of a function which has a stable critical point or a birth-death point at the origin. Note that this condition is symmetric in  $Q_s$  and  $P_t$ . We may refer to a tangency as stable or unstable, and as a center, saddle, or birth-death point.

A tangency of  $S$  with a  $\tau$ -level is said to be *stable* if there are local  $xyz$ -coordinates in which the  $\tau$ -levels are the planes  $\mathbb{R}^2 \times \{z\}$  and  $S$  is the graph of  $z = x^2$  in the  $xz$ -plane. In particular, the tangency is isolated and cannot occur at a vertex of  $S$ . There is an analogous definition of stable tangency of  $T$  with a  $\sigma$ -level.

We will say that  $\sigma$  and  $\tau$  are in *Morse general position* when the following hold:

- (1)  $S$  is disjoint from  $T$ ,
- (2) all tangencies of  $S$  with  $\tau$ -levels and of  $T$  with  $\sigma$ -levels are stable,
- (3) all tangencies of  $\sigma$ -levels with  $\tau$ -levels are of Morse type, and only finitely many are birth-death points,
- (4) each pair consisting of a  $\sigma$ -level and a  $\tau$ -level has at most two tangencies, and
- (5) there are only finitely many pairs consisting of a  $\sigma$ -level and a  $\tau$ -level with two tangencies, and for each of these pairs both tangencies are stable.

Suppose that  $P$  is a Heegaard surface in  $M$ , bounding a handlebody  $V$ . We define a *precompression* or *precompressing disk* for  $P$  in  $V$  to be an embedded disk  $D$  in  $M$  such that

- (1)  $\partial D$  is an essential loop in  $P$ ,
- (2)  $D$  meets  $P$  transversely at  $\partial D$ , and  $V$  contains a neighborhood of  $\partial D$ ,
- (3) the interior of  $D$  is transverse to  $P$ , and its intersections with  $P$  are discal.

Provided that  $M$  is irreducible, a precompression for  $P$  in  $V$  is isotopic relative to a neighborhood of  $\partial D$  to a compressing disk for  $P$  in  $V$ . In particular, if the Heegaard splitting is strongly irreducible, then the boundaries of a precompression for  $P$  in  $V$  and a precompression for  $P$  in  $\overline{M - V}$  must intersect.

The following concept due to A. Casson and C. McA. Gordon [9] is a crucial ingredient in [58]. A Heegaard splitting  $M = V \cup_P W$  is called *strongly irreducible* when every compressing disk for  $V$  meets every compressing disk for  $W$ . A sweepout is called *strongly irreducible* when the associated Heegaard splittings are strongly irreducible. We can now state the main technical result of [58].

**THEOREM 5.6.1** (Rubinstein-Scharlemann). *Let  $M \neq S^3$  be a closed orientable 3-manifold, and let  $\sigma, \tau: F \times [0, 1] \rightarrow M$  be strongly irreducible sweepouts of  $M$  which are in Morse general position. Then there exists  $(s, t) \in (0, 1) \times (0, 1)$  such that  $Q_s$  and  $P_t$  meet in good position.*

We will now review the proof of Theorem 5.6.1. The closure in  $I^2$  of the set  $(s, t)$  for which  $Q_s$  and  $P_t$  have a tangency is a graph  $\Gamma$ . On  $\partial I^2$ , it can have valence-1 vertices corresponding to valence-3 vertices of  $S$  or  $T$ , and valence-2 vertices corresponding to points of tangency of  $S$  with a  $\tau$ -level or  $T$  with a  $\sigma$ -level (see p. 1008 of [58], see also [40] for an exposition with examples). In the interior of  $I^2$ , it can have valence-4 vertices which correspond to a pair of levels which have two stable tangencies, and valence-2 vertices which correspond to pairs of levels having a birth-death tangency.

The components of the complement of  $\Gamma$  in the interior of  $I^2$  are called *regions*. Each region is either unlabeled or bears a label consisting of up to four letters. The labels are determined by the following conditions on  $Q_s$  and  $P_t$ , which by transversality hold either for every  $(s, t)$  or for no  $(s, t)$  in a region.

- (1) If  $Q_s$  contains a precompression for  $P_t$  in  $V_t$  (respectively, in  $W_t$ ), the region receives the letter  $A$  (respectively,  $B$ ).

- (2) If  $P_t$  contains a precompression for  $Q_s$  in  $X_s$  (respectively, in  $Y_s$ ), the region receives the letter  $X$  (respectively,  $Y$ ).
- (3) If the region has neither an  $A$ -label nor a  $B$ -label, and  $V_t$  (respectively,  $W_t$ ), contains a spine of  $Q_s$ , the region receives the letter  $b$  (respectively,  $a$ ).
- (4) If the region has neither an  $X$ -label nor a  $Y$ -label, and  $X_s$  (respectively,  $Y_s$ ), contains a spine of  $P_t$ , the region receives the letter  $y$  (respectively,  $x$ ).

With these conventions,  $Q_s$  and  $P_t$  are in good position if and only if the region containing  $(s, t)$  is unlabeled. To check this, assume first that they are in good position. Since all intersections are biessential or discal, neither surface can contain a precompressing disk for the other, and since there is a biessential intersection circle, the complement of one surface cannot contain a spine for the other. For the converse, an intersection circle which is not biessential or discal leads to a precompression as in (1) or (2), so assume that all intersections are discal. Then the complement of the intersection circles in  $Q_s$  contains a spine, so the region has either an  $a$ - or  $b$ -label, and by the same reasoning applied to  $P_t$  the region has either an  $x$ - or  $y$ -label. This verifies the assertion, as well as the following lemma.

LEMMA 5.6.2. *If the label of a region contains the letter  $a$  or  $b$ , then it must also contain either  $x$  or  $y$ . Similarly, if it contains  $x$  or  $y$ , then it must also contain  $a$  or  $b$ .*

We call the data consisting of the graph  $\Gamma \subset I^2$  and the labeling of a subset of its regions the *Rubinstein-Scharlemann graphic* associated to the sweepouts. Regions of the graphic are called *adjacent* if there is an edge of  $\Gamma$  which is contained in both of their closures.

At this point, we begin to make use of the fact that the sweepouts are strongly irreducible. The labels will then have the following properties, where  $A$  stands for either of  $A$  and  $a$ , and  $B$ ,  $X$ , and  $Y$  are defined similarly.

- (RS1) A label cannot contain both an  $A$  and a  $B$ , or both an  $X$  and a  $Y$  (direct from the labeling rules and the definition of strong irreducibility).
- (RS2) If the label of a region contains  $A$ , then the label of any adjacent region cannot contain  $B$ . Similarly for  $X$  and  $Y$  (Corollary 5.5 of [58]).
- (RS3) If all four letters  $A$ ,  $B$ ,  $X$ , and  $Y$  appear in the labels of the regions that meet at a valence-4 vertex of  $\Gamma$ , then two opposite regions must be unlabeled (Lemma 5.7 of [58]).

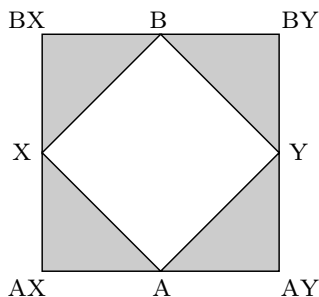

FIGURE 5.4. The Diagram.

Property (RS2) warrants special comment, since it will play a major role in our later work. The analysis of labels of adjacent regions given in Section 5 of [58] uses only the fact that for the points  $(s, t)$  in an open edge of  $\Gamma$ , the corresponding  $Q_s$  and  $P_t$  have a single stable tangency. The open edges of the more general graphics we will use for the diffeomorphisms in parameterized families in general position will still have this property, so the labels of their graphics will still satisfy property (RS2). They will not satisfy property (RS3), indeed the  $\Gamma$  for their graphics can have vertices of high valence, so property (RS3) will not even be meaningful.

We now analyze the labels of regions whose closures meet  $\partial I^2$ , as on p. 1012 of [58]. Consider first a region whose closure meets the side  $s = 0$  (we consider  $s$  to be the horizontal coordinate, so this is the left-hand side of the square). The region must contain points  $(s, t)$  with  $s$  arbitrarily close to 0. These correspond to  $Q_s$  which are extremely close to  $S_0$ . For almost all  $t$ ,  $S_0$  is transverse to  $P_t$ , and for sufficiently small  $s$  any intersection of such a  $P_t$  with  $Q_s$  must be an essential circle of  $Q_s$  bounding a disk in  $P_t$  that lies in  $X_s$ , in which case the region must have an  $X$ -label. If  $P_t$  is disjoint from  $Q_s$ , then  $P_t$  lies in  $Y_s$  so the region has an  $x$ -label. That is, all such regions have an  $x$ -label. Similarly, the label of any region whose closure meets the edge  $t = 0$  (respectively,  $s = 1, t = 1$ ) contains A (respectively, Y, B).

We will set up some of the remaining steps a bit differently from those of [58], so that their adaptation to our later arguments will be more transparent. We have seen that it is sufficient to prove that there exists an unlabeled region in the graphic defined by the sweepouts. To accomplish this, Rubinstein and Scharlemann use the shaded subset of the square shown in Figure 5.4. It is a simplicial complex in which each of the four triangles is a 2-simplex. Henceforth we will refer to it as *the Diagram*.

Suppose for contradiction that every region in the Rubinstein-Scharlemann graphic is labeled. Let  $\Delta$  be a triangulation of  $I^2$  such

that each vertex of  $\Gamma$  and each corner of  $I^2$  is a 0-simplex, and each edge of  $\Gamma$  is a union of 1-simplices. Let  $K$  be  $I^2$  with the structure of a regular 2-complex dual to  $\Delta$ . We observe the following properties of  $K$ :

- (K1) Each 0-cell of  $K$  lies in the interior of a side of  $\partial I^2$  or in a region.
- (K2) Each 1-cell of  $K$  either lies in  $\partial I^2$ , or is disjoint from  $\Gamma$ , or crosses one edge of  $\Gamma$  transversely in one point.
- (K3) Each 2-cell of  $K$  either contains no vertex of  $\Gamma$ , in which case all of its 0-cell faces that are not in  $\partial I^2$  lie in one region or in two adjacent regions, or contains one vertex of  $\Gamma$ , in which case all of its 0-cell faces which do not lie in  $\partial I^2$  lie in the union of the regions whose closures contain that vertex.

We now construct a map from  $K$  to the Diagram. First, each 0-cell in  $\partial K$  is sent to one of the single-letter 0-simplices of the diagram: if it lies in the side  $s = 0$  (respectively,  $t = 0$ ,  $s = 1$ ,  $t = 1$ ) then it is sent to the 0-simplex labeled  $x$  (respectively,  $A$ ,  $Y$ ,  $B$ ). Similarly, any 1-cell in a side of  $\partial K$  is sent to the 0-simplex that is the image of its endpoints, and the four 1-cells in  $\partial K$  dual to the original corners are sent to the 1-simplex whose endpoints are the images of the endpoints of the 1-cell. Notice that  $\partial K$  maps essentially onto the circle consisting of the four diagonal 1-simplices of the Diagram.

We will now show that if there is no unlabeled region, this map extends to  $K$ , a contradiction. Since an unlabeled region produces pairs  $Q_s$  and  $P_t$  that meet in good position, this will complete the proof sketch of Theorem 5.6.1.

Now we consider cells of  $K$  that do not lie entirely in  $\partial K$ . Each 0-cell in the interior of  $K$  lies in a region. By (RS1), the label of each 0-cell has a form associated to one of the 0-simplices of the Diagram, and we send the 0-cell to that 0-simplex.

Consider a 1-cell of  $K$  that does not lie in  $\partial K$ . Suppose it has one endpoint in  $\partial K$ , say in the side  $s = 0$  (the other cases are similar). The other endpoint lies in a region whose closure meets the side  $s = 0$ , so its label contains  $x$ . Therefore the images of the endpoints of the 1-cell both contain  $x$ , so lie either in a 0-simplex or a 1-simplex of the Diagram. We extend the map to the 1-cell by sending it into that 0- or 1-simplex. Suppose the 1-cell lies in the interior of  $K$ . Its endpoints lie either in one region or in two adjacent regions. If the former, or the latter and the labels of the regions are equal, we send the 1-cell to the 0-simplex for that label. If the latter and the labels of the regions



are different, then property (RS2) shows that the labels span a unique 1-simplex of the Diagram, in which case we send the 1-cell to that 1-simplex.

Assuming that the map has been extended to the 1-cells in this way, consider a 2-cell of  $K$ . Suppose first that it has a face that meets the side  $s = 0$  (the other cases are similar). Then each of its 0-cell faces lies in one of the sides  $s = 0$ ,  $t = 0$ , or  $t = 1$ , or in a region whose closure meets  $s = 0$ . In the latter case, we have seen that the label of the region must contain  $x$ , so it cannot contain  $y$ , and in particular it cannot be a single letter  $y$ . In no case does the 0-cell map to the vertex  $y$  of the Diagram, so the image of the boundary of the 2-cell maps into the complement of that vertex in the Diagram. Since that complement is contractible, the map extends over the 2-cell.

Suppose now that the 2-cell lies entirely in the interior of  $K$ . If it is dual to a 0-simplex of  $\Delta$  that lies in a region or in the interior of an edge of  $\Gamma$ , then all its 0-cell faces lie in a region or in two adjacent regions. In this case, all of its 1-dimensional faces map into some 1-simplex of the Diagram, so the map on the faces extends to a map of the 2-cell into that 1-simplex. Suppose the 2-cell is dual to a vertex of  $\Gamma$ . Its faces lie in the union of regions whose closures contain the vertex. If the vertex has valence 2, then all 0-cell faces lie in two adjacent regions (actually, in this case, the regions must have the same label) and the map extends to the 2-cell as before. If the vertex has valence 4, then by (RS3), the labels of the four regions whose closures contain the vertex must all avoid at least one of the four letters. This implies that the boundary of the 2-cell of  $K$  maps into a contractible subset of the Diagram. So again the map can be extended over the 2-cell, giving us the desired contradiction.

We emphasize that the map from  $K$  to the Diagram carries each 1-cell of  $K$  to a 0-simplex or a 1-simplex of the Diagram, principally due to property (RS2).

### 5.7. Graphics having no unlabeled region

One cannot hope to perturb a parameterized family of sweepouts to be in Morse general position. One must allow for the possibility of levels having tangencies of high order, and having more than two tangencies. We will see in Section 5.8 that all such phenomena can be isolated at the vertices of the graph  $\Gamma$  in the graphic. In particular, the  $(s, t)$  that lie on the open edges of  $\Gamma$  will still correspond to pairs of levels that have a single stable tangency, and therefore their associated graphics will still have property (RS2). Achieving this property for the

edges of  $\Gamma$  will require considerable effort, so before beginning the task, we will show that the hard work really is necessary. We will give here an example of a pair of sweepouts on  $S^2 \times S^1$  (that is, on  $L(0, 1)$ ) which have a graphic with no unlabeled region. It will be clear that what goes wrong is the existence of edges of  $\Gamma$  that consist of pairs having multiple tangencies, and the corresponding failure of the graphic to have property (RS2).

We do not have an explicit counterexample of this kind on a lens space, which would be even more complicated to describe, but we think it is fairly clear that the construction, which starts with a simple pair of sweepouts and “closes up” a good region in their graphic, could be carried out on a typical pair of sweepouts.

This section is not part of the proof of the Smale Conjecture for Lens Spaces, and can be read independently (provided that one is familiar with Rubinstein-Scharlemann graphics and their labeling scheme).

The first step is to construct a pair of sweepouts of  $S^2 \times S^1$ , with the graphic shown on the left in Figure 5.5. In Figure 5.5, the edges of pairs for which the corresponding levels have a single center tangency are shown as dotted. The four corner regions are not labeled, since their labels are the same as the regions that are adjacent to them along an edge of centers.

After constructing the sweepouts that produce the first graphic, we will see how to move one of the sweepouts by isotopy to “collapse” the unlabeled region. Two edges of the first graphic are moved to coincide, producing the graphic on the right in Figure 5.5. The three open edges that lie on the diagonal  $y = x$  consist of pairs of levels which have two saddle tangencies. The two vertices where the edges labeled 1 and 4 cross the diagonal at points corresponding to pairs having three saddle tangencies.

As it is rather difficult to visualize the sweepouts directly, we describe them by level pictures for various  $P_t$ . The  $Q_s$  appear as level curves in each  $P_t$ . Here are some general conventions:

- (i) A solid dot is a center tangency.
- (ii) An open dot (i. e. a tiny circle) is a point in one of the singular circles  $S_i$  of the  $Q_s$ -sweepout.
- (iii) Double-thickness lines are intersections with a  $Q_s$  that have more than one tangency.
- (iv) Dashed lines are biessential intersection circles.

In a picture of a  $P_t$ , the level curves  $P_t \cap Q_s$  that contain saddles appear as curves with self-crossings, and we label the crossings with 1, 2, 3, or 4 to indicate which edge of the graphic in Figure 5.5 contains

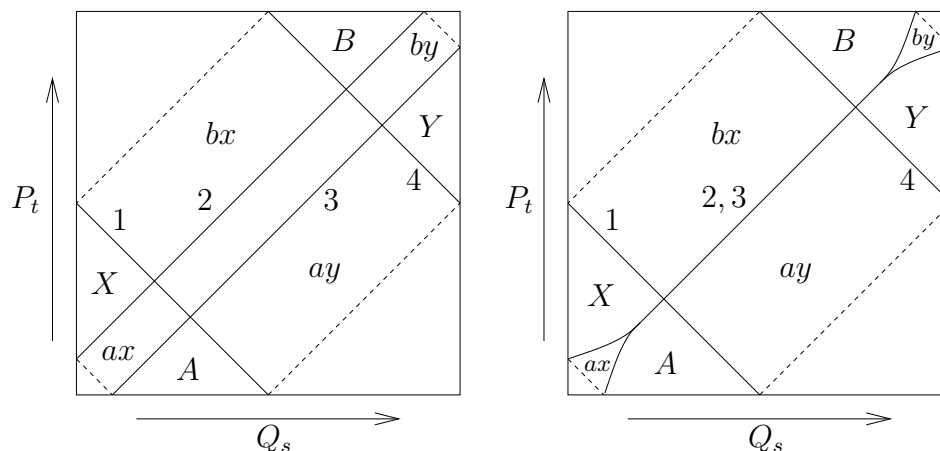

FIGURE 5.5. Graphics before and after deformation.

that  $(s, t)$ -pair. For a fixed  $t$ ,  $s(n)$  will denote the  $s$ -level of saddle  $n$ . That is, in the graphic the edge of  $\Gamma$  labeled  $n$  contains the point  $(s(n), t)$ .

Figure 5.6 shows some  $P_t$  with  $t \leq 1/2$ , for a sweepout of  $S^2 \times S^1$  whose graphic is the one shown in the left of Figure 5.5. Here are some notes on Figure 5.6.

- (1) In (a)-(f), the circles  $x = \text{constant}$  are longitudes of  $V_t$ , and the circles  $y = \text{constant}$  are meridians.
- (2) The point represented by the four corners is the point of  $P_t$  with largest  $s$ -level. In (a) it is a tangency of  $P_{1/2}$  with  $S_1$ , and in (b)-(f) it is a center tangency of  $P_t$  with  $Q_{t+1/2}$ .
- (3) The open dots in the interior of the squares are intersections of  $P_t$  with  $S_0$ . In (a) it is a tangency of  $P_{1/2}$  with  $S_0$ , in (b)-(e) they are transverse intersections. In (f),  $P_t$  is disjoint from  $S_0$ .
- (4) In (b), saddle 1 has appeared. Circles of  $Q_s \cap P_t$  with  $s < s(1)$  are essential in  $Q_s$ , and these  $(s, t)$  lie in the region labeled  $X$  in the graphic. Circles of  $Q_s \cap P_t$  with  $s(1) < s < s(2)$  enclose the figure-8 in (b), which is  $P_t \cap Q_{s(1)}$ . They are inessential in both  $Q_s$  and  $P_t$ , and these  $(s, t)$  lie in the region labeled  $bx$ . The vertical dotted lines are biessential intersections corresponding to a pair in the unlabeled region. Finally, one crosses  $Q_{s(3)}$ , and eventually reaches the center tangency.
- (5) The horizontal level curves shown in (f) are meridians of  $V_t$  that bound disks in the  $Q_s$  that contain them. This  $(s, t)$  lies in the region labeled  $A$  in the graphic.

For  $t > 1/2$ , the intersection pattern of  $P_t$  with the  $Q_s$  is isomorphic to the pattern for  $P_{1-t}$ , by an isomorphism for which  $Q_s$  corresponds

to  $Q_{1-s}$ . As one starts  $t$  at  $1/2$  and moves upward through  $t$ -levels, saddle 4 appears inside the component of  $P_t - Q_{s(3)}$  that is an open disk, and expands until the level where  $s(3) = s(4)$ . The biessential intersection circles in (a)-(d) are again longitudes in  $V_t$  and in  $W_t$ , and the horizontal intersection circles in (f) are meridians of  $W_t$ . These  $(s, t)$  lie in the region labeled  $B$  in the graphic. This completes the description of the sweepouts in Morse general position.

Figure 5.7 shows some  $P_t$  for a sweepout of  $S^2 \times S^1$  whose graphic is the one shown in the right of Figure 5.5. This sweepout is obtained from the previous one by an isotopy that moves parts of the  $Q_s$  levels down (to lower  $t$ -levels) near saddle 2 and up near saddle 3. Again, the portion that is shown fits together with a similar portion for  $1/2 \leq t \leq 1$ . As  $t$  increases past  $1/2$ , saddle 4 appears in the component of  $P_t - S_{s(2)}$  that contains the point which appears as the four corners.

### 5.8. Graphics for parameterized families

In this section we prove that a parameterized family of sweepouts can be perturbed so that a suitable graphic exists at each parameter. As discussed in Section 5.7, in a parameterized family one must allow for the possibility of levels having tangencies of high order, and having more than two tangencies.

Additional complications arise because one cannot avoid having parameters where the singular sets of the sweepouts intersect, or where the singular sets have high-order tangencies with levels. We sidestep these complications by working only with sweepout parameters that lie in an interval  $[\epsilon, 1 - \epsilon]$ . The graphic is only considered to exist on the square  $[\epsilon, 1 - \epsilon] \times [\epsilon, 1 - \epsilon]$ , which we call  $I_\epsilon^2$ . The number  $\epsilon$  is chosen so that the labels of regions whose closure meets a side of  $I_\epsilon^2$  will be known to include certain letters. Just as before, this will ensure that the map to the Diagram be essential on the boundary of the dual complex  $K$ .

These considerations motivate our definition of a general position family of diffeomorphisms. As usual, let  $M$  be a closed orientable 3-manifold and  $\tau: P \times [0, 1] \rightarrow M$  a sweepout with singular set  $T = T_0 \cup T_1$  and level surfaces  $P_t$  bounding handlebodies  $V_t$  and  $W_t$ . Let  $f: M \times W \rightarrow M$  be a parameterized family of diffeomorphisms, where  $W$  is a compact manifold. For  $u \in W$  we denote the restriction of  $f$  to  $M \times \{u\}$  by  $f_u$ . When a choice of parameter  $u$  has been fixed, we denote  $f_u(P_s)$  by  $Q_s$ , and  $f_u(V_s)$  and  $f_u(W_s)$  by  $X_s$  and  $Y_s$  respectively. When  $Q_s$  meets  $P_t$  transversely, a label is assigned to  $(s, t)$  as in Section 5.6.

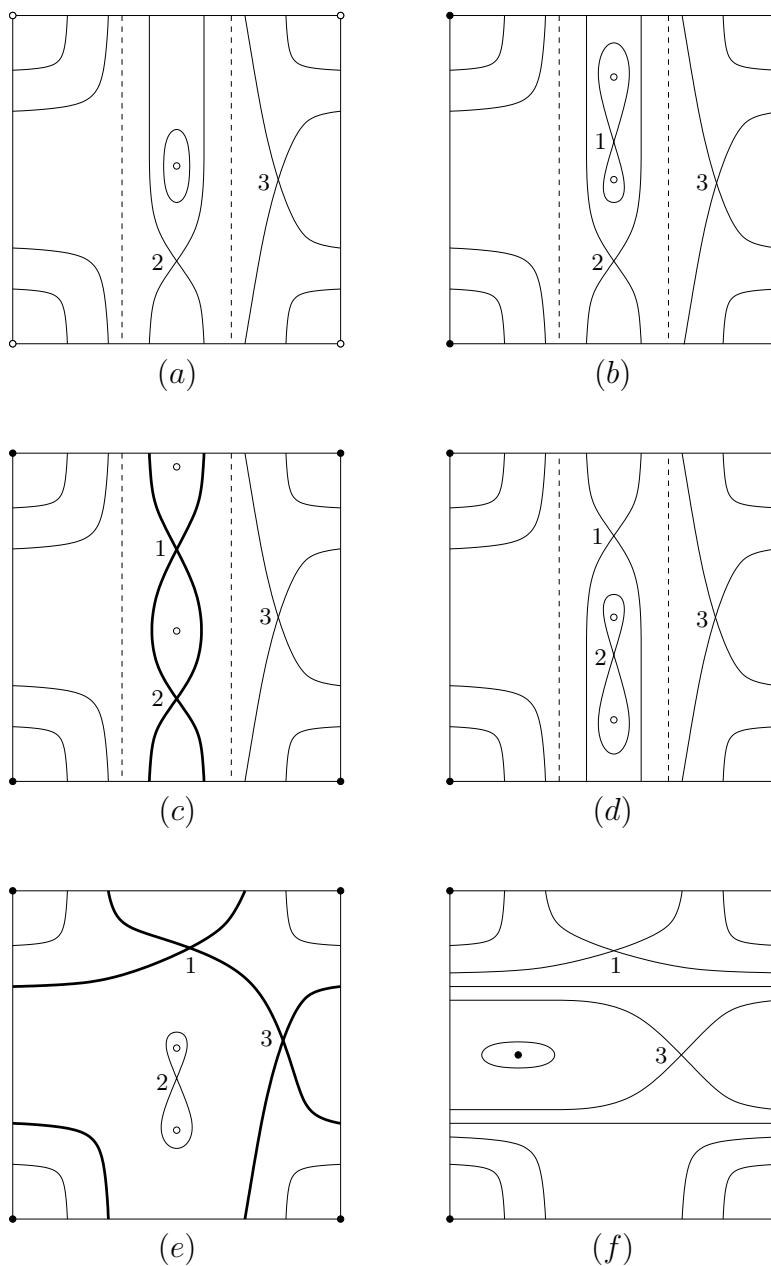

FIGURE 5.6. Intersections of the  $Q_s$  with fixed  $P_t$  as  $t$  decreases from  $1/2$  to  $0$ , for the sweepouts with an unlabeled region.

- (a)  $P_{1/2}$ .
- (b)  $P_t$  where  $s(1) < s(2) < s(3)$ .
- (c)  $P_t$  where  $s(1) = s(2)$ .
- (d)  $P_t$  where  $s(2) < s(1) < s(3)$ .
- (e)  $P_t$  where  $s(1) = s(3)$ .
- (f)  $P_t$  where  $s(3) < s(1)$ , and after saddle 2 changes to a center.

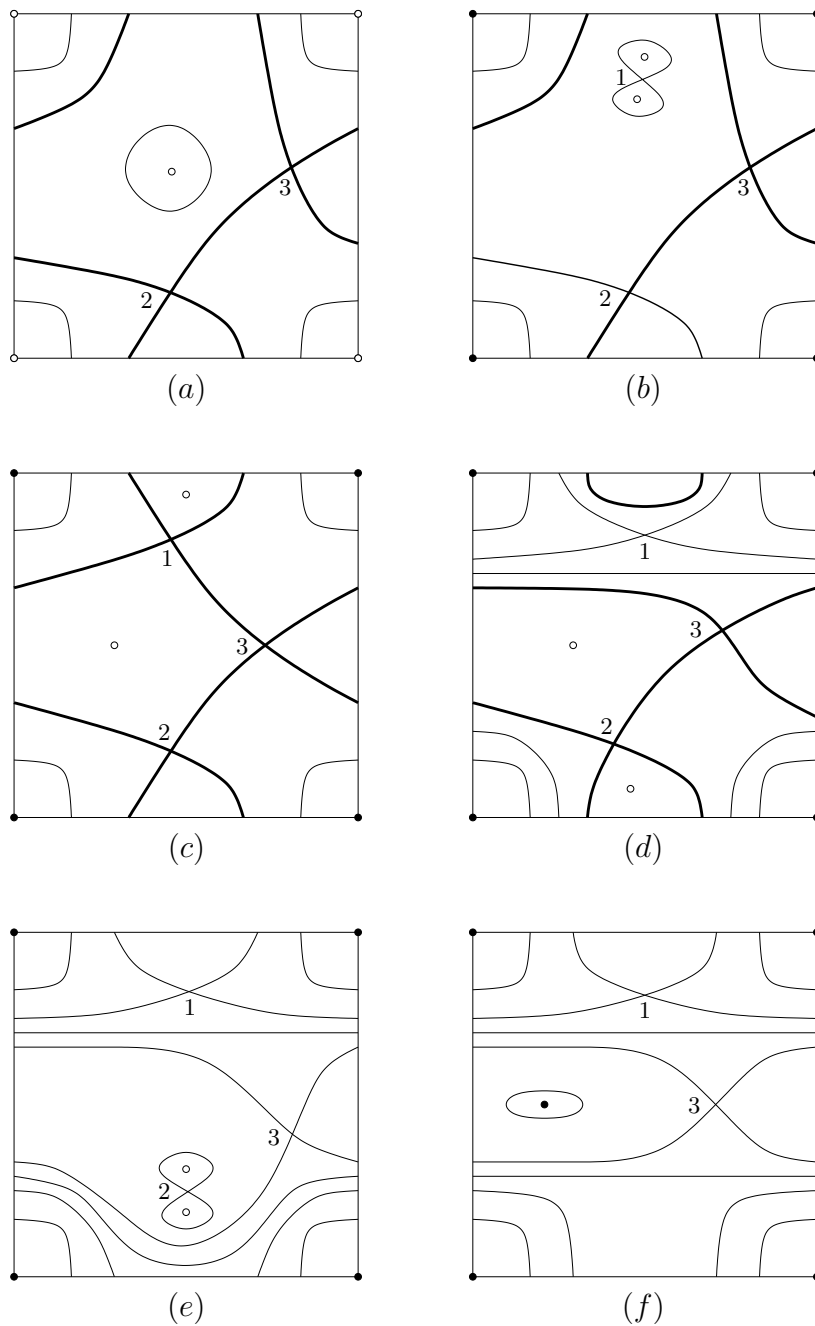

FIGURE 5.7. Intersections of the  $Q_s$  with fixed  $P_t$  as  $t$  decreases from  $1/2$  to  $0$ , for the sweepouts with no unlabeled region.

- (a)  $P_{1/2}$ .
- (b)  $P_t$  where  $s(1) < s(2) = s(3)$ .
- (c)  $P_t$  where  $s(1) = s(2) = s(3)$ .
- (d)  $P_t$  where  $s(2) = s(3) < s(1)$ .
- (e)  $P_t$  where  $s(2) < s(3) < s(1)$ .
- (f)  $P_t$  where  $s(3) < s(1)$ , and after saddle 2 changes to a center.

A preliminary definition will be needed. We say that a positive number  $\epsilon$  *gives border label control* for  $f$  if the following hold at each parameter  $u$ :

- (1) If  $t \leq 2\epsilon$ , then there exists  $r$  such that  $Q_r$  meets  $P_t$  transversely and contains a compressing disk of  $V_t$ .
- (2) If  $t \geq 1 - 2\epsilon$ , then there exists  $r$  such that  $Q_r$  meets  $P_t$  transversely and contains a compressing disk of  $W_t$ .
- (3) If  $s \leq 2\epsilon$ , then there exists  $r$  such that  $P_r$  meets  $Q_s$  transversely and contains a compressing disk of  $X_s$ .
- (4) If  $s \geq 1 - 2\epsilon$ , then there exists  $r$  such that  $P_r$  meets  $Q_s$  transversely and contains a compressing disk of  $Y_s$ .

Throughout this section, a *graph* is a compact space which is a disjoint union of a CW-complex of dimension  $\leq 1$  and circles. The circles, if any, are considered to be open edges of the graph.

We say that  $f$  is *in general position* (with respect to the sweepout  $\tau$ ) if there exists  $\epsilon > 0$  such that  $\epsilon$  gives border label control for  $f$  and such that the following hold for each parameter  $u \in W$ .

- (GP1) For each  $(s, t)$  in  $I_\epsilon^2$ ,  $Q_s \cap P_t$  is a graph. At each point in an open edge of this graph,  $Q_s$  meets  $P_t$  transversely. At each vertex, they are tangent.
- (GP2) The  $(s, t) \in I_\epsilon^2$  for which  $Q_s$  has a tangency with  $P_t$  form a graph  $\Gamma_u$  in  $I_\epsilon^2$ .
- (GP3) If  $(s, t)$  lies in an open edge of  $\Gamma_u$ , then  $Q_s$  and  $P_t$  have a single stable tangency.

The next lemma is immediate from the definition of border label control and the labeling rules for regions. It does not require that we be working with lens spaces, so we state it as a lemma with weaker hypotheses.

LEMMA 5.8.1. *Suppose that  $f: M \times W \rightarrow M$  is in general position with respect to  $\tau$ . Assume that  $M \neq S^3$  and that the Heegaard splittings associated to  $\tau$  are strongly irreducible. Suppose that  $\epsilon$  gives border label control for  $f$ .*

- (1) *If  $t \leq \epsilon$ , then the label of  $(s, t)$  contains  $A$ .*
- (2) *If  $t \geq 1 - \epsilon$ , then the label of  $(s, t)$  contains  $B$ .*
- (3) *If  $s \leq \epsilon$ , then the label of  $(s, t)$  contains  $X$ .*
- (4) *If  $s \geq 1 - \epsilon$ , then the label of  $(s, t)$  contains  $Y$ .*

Here is the main result of this section.

**THEOREM 5.8.2.** *Let  $f: M \times W \rightarrow M$  be a parameterized family of diffeomorphisms. Then by an arbitrarily small deformation,  $f$  can be put into general position with respect to  $\tau$ .*

The proof of Theorem 5.8.2 will constitute the remainder of this section. Since the argument is rather long, we will break it into subsections. Until Subsection 5.8.6,  $M$  can be a closed manifold of arbitrary dimension  $m$ .

**5.8.1. Weak transversality.** Although individual maps may be put transverse to a submanifold of the range, it is not possible to perturb a parameterized family so that each individual member of the family is transverse. But a very nice result J. W. Bruce, Theorem 1.1 of [8], allows one to simultaneously improve the members of a family.

**THEOREM 5.8.3 (J. W. Bruce).** *Let  $A$ ,  $B$  and  $U$  be smooth manifolds and  $C \subset B$  a submanifold. There is a residual family of mappings  $F \in C^\infty(A \times U, B)$  such that:*

- (a) *For each  $u \in U$ , the restriction  $F_u = F|_{A \times \{u\}}: A \rightarrow B$  is transverse to  $C$  except possibly on a discrete set of points.*
- (b) *For each  $u \in U$ , the set  $F_u^{-1}(C)$  is a smooth submanifold of codimension equal to the codimension of  $C$  in  $B$ , except possibly at a discrete set of points. At each of these exceptional points  $F_u^{-1}(C)$  is locally diffeomorphic to the germ of an algebraic variety, with the exceptional point corresponding to an isolated singular point of the variety.*

That is,  $F_u^{-1}(C)$  is smooth except at isolated points where it has topologically a nice cone-like structure. It is not assumed that any of the manifolds involved is compact.

Theorem 1.3 of [8] is a version of Theorem 5.8.3 in which  $C$  is replaced by a bundle  $\phi: B \rightarrow D$ . The statement is:

**THEOREM 5.8.4 (J. W. Bruce).** *For a residual family of mappings  $F \in C^\infty(A \times U, B)$ , the conclusions of Theorem 5.8.3 hold for all submanifolds  $C = \phi^{-1}(d)$ ,  $d \in D$ .*

We should comment on the significance of the residual subset in these two theorems. The method of proof of these theorems is to define, in an appropriate jet space, a locally algebraic subset which contains the jets of all the maps that fail these weak transversality conditions. These subsets have increasing codimension as higher-order jets are taken. A variant of Thom transversality (Lemma 1.6 of [8])



allows one to perturb a parameterized family of maps so that these jets are avoided and the conclusion holds. When  $A$  and  $W$  are compact, the image of  $A \times W$  will lie in the open complement of the locally algebraic sets of sufficiently high codimension. Consequently, any map sufficiently close to the perturbed map will also satisfy the conclusions of the theorems. In all of our applications, the spaces involved will be compact, and *we tacitly assume that the result of any procedure holds on an open neighborhood of the perturbed map.*

We now adapt the methodology of Bruce to prove a version of Theorem 5.8.3 in which the submanifold  $C$  is replaced by the zero set of a nontrivial polynomial. We will prove it only for the case when  $A = I$ , although a more general version should be possible.

**PROPOSITION 5.8.5.** *Let  $P: \mathbb{R}^n \rightarrow \mathbb{R}$  be a nonzero polynomial and put  $V = P^{-1}(0)$ . Let  $W$  be compact. Then for all  $G$  in an open dense subset of  $C^\infty(I \times W, \mathbb{R}^n)$ , each  $G_u^{-1}(V)$  is finite.*

**PROOF.** Let  $J_0^k(1, n)$  be the space of germs of degree- $k$  polynomials from  $(\mathbb{R}, 0)$  to  $\mathbb{R}^n$ ; an element of  $J_0^k(1, n)$  can be written as  $(a_{1,0} + a_{1,1}t + \cdots + a_{1,k}t^k, \dots, a_{n,0} + a_{n,1}t + \cdots + a_{n,k}t^k)$ , so that  $J_0^k(1, n)$  can be identified with  $\mathbb{R}^{(k+1)n}$ . Note that the jet space  $J^k(I, \mathbb{R}^n)$  can be regarded as  $I \times J_0^k(1, n)$ , by identifying the jet of  $\alpha: I \rightarrow \mathbb{R}^n$  at  $t_0$  with the jet of  $\alpha(t - t_0)$  at 0.

Define a polynomial map  $P_*: J_0^k(1, n) \rightarrow J_0^k(1, 1)$  by applying  $P$  to the  $n$ -tuple  $(a_{1,0} + a_{1,1}t + \cdots + a_{1,k}t^k, \dots, a_{n,0} + a_{n,1}t + \cdots + a_{n,k}t^k)$ , and then taking only the terms up to degree  $k$ . The inverse image  $P_*^{-1}(0)$  is the set of  $k$ -jets  $\alpha$  in  $\mathbb{R}^n$  such that  $P(\alpha(0)) = 0$  and the first  $k$  derivatives of  $P \circ \alpha$  vanish at  $t = 0$ , that is, the set of germs of paths that lie in  $V$  up to  $k^{\text{th}}$ -order.

**LEMMA 5.8.6.** *If  $P$  is nonconstant, then the codimension of  $P_*^{-1}(0)$  goes to  $\infty$  as  $k \rightarrow \infty$ .*

**PROOF OF LEMMA 5.8.6.** It suffices to show that the rank of the Jacobian of  $P_*$  goes to  $\infty$  as  $k \rightarrow \infty$ . For notational simplicity, we will give the proof for  $P(X, Y)$ , and it will be evident how the argument extends to the general case.

Write  $a = a_0 + a_1t + a_2t^2 + \cdots$  and  $b = b_0 + b_1t + b_2t^2 + \cdots$ , and examine  $P(a, b)$ . We have  $P_*(a, b) = Q_0 + Q_1t + Q_2t^2 + \cdots$  where each  $Q_i$  is a (finite) polynomial in  $\mathbb{R}[a_0, b_0, a_1, b_1, \dots]$ . Notice that  $Q_j = \left. \frac{1}{j!} \frac{\partial^j P_*}{\partial t^j} \right|_{t=0}$ .

It is instructive to calculate a few derivatives of  $P_*(a, b)$ . We have

$$\begin{aligned}\frac{\partial P_*}{\partial t} &= a'P_X + b'P_Y \\ \frac{\partial^2 P_*}{\partial t^2} &= a''P_X + b''P_Y + (a')^2P_{XX} + 2a'b'P_{XY} + (b')^2P_{YY} \\ \frac{\partial^3 P_*}{\partial t^3} &= a'''P_X + b'''P_Y + a''a'P_{XX} + (a''b' + a'b'')P_{XY} + b''b'P_{YY} \\ &\quad + 2a'a''P_{XX} + (2a''b' + 2a'b'')P_{XY} + 2b'b''P_{YY} \\ &\quad + (a')^3P_{XXX} + 3(a')^2b'P_{XXY} + 3a'(b')^2P_{XY^2} + (b')^3P_{YYY} \\ &= a'''P_X + b'''P_Y + 3a''a'P_{XX} + 3(a''b' + a'b'')P_{XY} + 3b''b'P_{YY} \\ &\quad + (a')^3P_{XXX} + 3(a')^2b'P_{XXY} + 3a'(b')^2P_{XY^2} + (b')^3P_{YYY}\end{aligned}$$

and at  $t = 0$  these become

$$\begin{aligned}Q_1 &= a_1P_X(a_0, b_0) + b_1P_Y(a_0, b_0) \\ 2!Q_2 &= 2a_2P_X(a_0, b_0) + 2b_2P_Y(a_0, b_0) \\ &\quad + a_1^2P_{XX}(a_0, b_0) + 2a_1b_1P_{XY}(a_0, b_0) + b_1^2P_{YY}(a_0, b_0) \\ 3!Q_3 &= 6a_3P_X(a_0, b_0) + 6b_3P_Y(a_0, b_0) + 6a_1a_2P_{XX}(a_0, b_0) \\ &\quad + 6(a_2b_1 + a_1b_2)P_{XY}(a_0, b_0) + 6b_1b_2P_{YY}(a_0, b_0) + a_1^3P_{XXX}(a_0, b_0) \\ &\quad + 3a_1^2b_1P_{XXY}(a_0, b_0) + 3a_1b_1^2P_{XY^2}(a_0, b_0) + b_1^3P_{YYY}(a_0, b_0)\end{aligned}$$

Induction shows that in general, writing  $K_{rX,sX}$  for  $\frac{\partial^{r+s}P}{\partial rX\partial sY}(a_0, b_0)$ , there are positive constants  $c_{i_1 \dots i_r j_1 \dots j_s}$  so that for large  $N$ ,

$$(1) \quad Q_N = \sum K_{rX,sY} \left( \sum c_{i_1 \dots i_r j_1 \dots j_s} a_{i_1} \cdots a_{i_r} b_{j_1} \cdots b_{j_s} \right).$$

For large  $N$ , all partial derivatives  $K_{rX,sY}$  of  $P$  at  $(a_0, b_0)$  appear, and some must be nonzero since  $P$  is a polynomial. Notice also that there is no cancellation due to values of the  $K_{rX,sY}$ , since each monomial term  $a_{i_1} \cdots a_{i_r} b_{j_1} \cdots b_{j_s}$  appears just once.

Any given  $a_i$  appears in some of the monomial terms of  $Q_N$  for all sufficiently large  $N$ . On the other hand,  $Q_N$  contains no  $a_i$  or  $b_i$  with  $i > N$ , so  $\frac{\partial Q_i}{\partial a_j}$  vanishes for  $j > i$ , and similarly for  $\frac{\partial Q_j}{\partial b_i}$ . Therefore if we

truncate at  $t^k$ , the Jacobian  $\left[ \left( \frac{\partial A_i}{\partial a_j} \right) \quad \left( \frac{\partial A_i}{\partial b_j} \right) \right]$  is a  $(k+1) \times 2(k+1)$  matrix consisting of (two, since we are in the case of a two-variable

$P(X, Y)$ ) upper triangular blocks:

$$\begin{bmatrix} * & 0 & 0 & \cdots & 0 & * & 0 & 0 & \cdots & 0 \\ * & * & 0 & \cdots & 0 & * & * & 0 & \cdots & 0 \\ & & & \ddots & & & & & \ddots & \\ * & * & & \cdots & 0 & * & * & & \cdots & 0 \\ * & * & & \cdots & * & * & * & & \cdots & * \end{bmatrix}.$$

If the lemma is false, then there is some maximal rank of these Jacobians as  $k \rightarrow \infty$ . That is, there are, say,  $m$  rows such that every row is an  $\mathbb{R}$ -linear combination of these rows. For values of  $k$  much larger than  $m$ , all of these  $m$  rows have zeros in the upper triangular part of the two blocks. On the other hand, Equation 1 and the observations that follow it show that for each fixed  $j$ ,  $\frac{\partial A_i}{\partial a_j}$  is nonzero for sufficiently large  $i$ . This completes the proof of Lemma 5.8.6.  $\square$

For each  $k$ , put  $Z_k = P_*^{-1}(0)$ . Lemma 5.8.6 shows that the codimension of  $Z_k$  in  $J_0^k(1, n)$  goes to  $\infty$  as  $k \rightarrow \infty$ . If  $\alpha: (\mathbb{R}, 0) \rightarrow \mathbb{R}^n$  is a germ of a smooth map, and 0 is a limit point of  $\alpha^{-1}(V)$ , then all derivatives of  $P \circ \alpha$  vanish at 0. That is, the  $k$ -jet of  $\alpha$  at  $t = 0$  is contained in  $Z_k$  for every  $k$ .

By Lemma 1.6 of [8], there is a residual set of maps  $G \in C^\infty(I \times W, \mathbb{R}^n)$  such that the jet extensions  $j^k G: I \times W \rightarrow J^k(I, \mathbb{R}^n)$  defined by  $j^k G(t, u) = j^k G_u(t)$  are transverse to  $I \times Z_k$ . For  $k + 1$  larger than the dimension of  $I \times W$ , this says that no point of  $G_u^{-1}(0)$  is a limit point, so each  $G_u^{-1}(0)$  is finite.  $\square$

**5.8.2. Finite singularity type.** For our later work, we will need some ideas from singularity theory. Let  $g: (\mathbb{R}^m, 0) \rightarrow (\mathbb{R}^p, 0)$  be a germ of a smooth map. There is a concept of *finite singularity type* for  $g$ , whose definition is readily available in the literature (for example, [8, p. 117]). The basic idea of the proof of Theorem 5.8.3 (given as Theorem 1.1 in [8]) is to regard the submanifold  $C$  locally as the inverse image of 0 under a submersion  $s$ , then to perturb  $f$  so that for each  $u$ , the critical points of  $s \circ f_u$  are of finite singularity type. In fact, this is exactly the definition of what it means for  $f_u$  to be weakly transverse to  $C$ . In particular, when  $C$  is a point, the submersion can be taken to be the identity, so we have:

**PROPOSITION 5.8.7.** *Let  $f: M \rightarrow \mathbb{R}$  be smooth. If  $f$  is weakly transverse to a point  $r \in \mathbb{R}$ , then at each critical point in  $f^{-1}(r)$ , the germ of  $f$  has finite singularity type.*

Let  $f$  and  $g$  be germs of smooth maps from  $(\mathbb{R}^m, a)$  to  $(\mathbb{R}^p, f(a))$ . They are said to be  $\mathcal{A}$ -equivalent if there exist a germ  $\varphi_1$  of a diffeomorphism of  $(\mathbb{R}^m, a)$  and a germ  $\varphi_2$  of a diffeomorphism of  $(\mathbb{R}^p, f(a))$  such that  $g = \varphi_2 \circ f \circ \varphi_1$ . If  $\varphi_2$  can be taken to be the identity, then  $f$  and  $g$  are called  $\mathcal{R}$ -equivalent (for *right-equivalent*). There is also a notion of contact equivalence, denoted by  $\mathcal{K}$ -equivalence, whose definition is readily available, for example in [72]. It is implied by  $\mathcal{A}$ -equivalence.

We use  $j^k f$  to denote the  $k$ -jet of  $f$ ; for fixed coordinate systems at points  $a$  and  $f(a)$  this is just the Taylor polynomial of  $f$  of degree  $k$ . For  $\mathcal{G}$  one of  $\mathcal{A}$ ,  $\mathcal{K}$ , or  $\mathcal{R}$ , one says that  $f$  is finitely  $\mathcal{G}$ -determined if there exists a  $k$  so that any germ  $g$  with  $j^k g = j^k f$  must be  $\mathcal{G}$ -equivalent to  $f$ . In particular, if  $f$  is finitely  $\mathcal{G}$ -determined, then for any fixed choice of coordinates at  $a$  and  $f(a)$ ,  $f$  is  $\mathcal{G}$ -equivalent to a polynomial.

The elaborate theory of singularities of maps from  $\mathbb{R}^m$  to  $\mathbb{R}^p$  simplifies considerably when  $p = 1$ .

LEMMA 5.8.8. *Let  $f$  be the germ of a map from  $(\mathbb{R}^m, 0)$  to  $(\mathbb{R}, 0)$ , with  $0$  is a critical point of  $f$ . The following are equivalent.*

- (i)  $f$  has finite singularity type.
- (ii)  $f$  is finitely  $\mathcal{A}$ -determined.
- (iii)  $f$  is finitely  $\mathcal{R}$ -determined.
- (iv)  $f$  is finitely  $\mathcal{K}$ -determined.

PROOF. In all dimensions,  $f$  is finitely  $\mathcal{K}$ -determined if and only if it is of finite singularity type (Corollary III.6.9 of [16], or alternatively the definition of finite singularity type of J. Bruce [8, p. 117] is exactly the condition given in Proposition (3.6)(a) of J. Mather [45] for  $f$  to be finitely  $\mathcal{K}$ -determined). Therefore (i) is equivalent to (iv). Trivially (ii) implies (iii), and (iii) implies (iv), and by Corollary 2.13 of [72], (iv) implies (ii).  $\square$

**5.8.3. Semialgebraic sets.** Recall (see for example Chapter I.2 of [16]) that the class of *semialgebraic* subsets of  $\mathbb{R}^m$  is defined to be the smallest Boolean algebra of subsets of  $\mathbb{R}^m$  that contains all sets of the form  $\{x \in \mathbb{R}^m \mid p(x) > 0\}$  with  $p$  a polynomial on  $\mathbb{R}^m$ . The collection of semialgebraic subsets of  $\mathbb{R}^m$  is closed under finite unions, finite intersections, products, and complementation. The inverse image of a semialgebraic set under a polynomial mapping is semialgebraic. A nontrivial fact is the Tarski-Seidenberg Theorem (Theorem II.2(2.1) of [16]), which says that a polynomial image of a semialgebraic set is a semialgebraic set. Here is an easy lemma that we will need later.

LEMMA 5.8.9. *Let  $S$  be a semialgebraic subset of  $\mathbb{R}^n$ . If  $S$  has empty interior, then  $S$  is contained in the zero set of a nontrivial polynomial in  $\mathbb{R}^n$ .*

PROOF. Since the union of the zero sets of two polynomials is the zero set of their product, it suffices to consider a single semialgebraic set of the form  $(\cap_{i=1}^r \{x \mid p_i(x) \geq 0\}) \cap (\cap_{j=1}^s \{x \mid q_j(x) > 0\})$  where  $p_i$  and  $q_j$  are nontrivial polynomials. We will show that if  $S$  is of this form and has empty interior, then  $r \geq 1$  and  $S$  is contained in the zero set of  $\prod_{i=1}^r p_i$ . Suppose that  $x \in S$  but all  $p_i(x) > 0$ . Since all  $q_j(x) > 0$  as well, there is an open neighborhood of  $x$  on which all  $p_i$  and all  $q_j$  are positive. But then,  $S$  has nonempty interior.  $\square$

**5.8.4. The codimension of a real-valued function.** It is, of course, fundamentally important that the Morse functions form an open dense subset of  $C^\infty(M, \mathbb{R})$ . But a great deal can also be said about the non-Morse functions. There is a “natural” stratification of  $C^\infty(M, \mathbb{R})$  by subsets  $\mathcal{F}_i$ , where stratification here means that the  $\mathcal{F}_i$  are disjoint subsets such that for every  $n$  the union  $\cup_{i=0}^n \mathcal{F}_i$  is open. The functions in  $\mathcal{F}_n$  are those of “codimension”  $n$ , which we will define below. In particular,  $\mathcal{F}_0$  is exactly the open dense subset of Morse functions.

The union  $\cup_{i=0}^\infty \mathcal{F}_i$  is not all of  $C^\infty(M, \mathbb{R})$ . However, the residual set  $C^\infty(M, \mathbb{R}) - \cup_{i=0}^\infty \mathcal{F}_i$  is of “infinite codimension,” and any parameterized family of maps  $F: M \times U \rightarrow \mathbb{R}$  can be perturbed so that each  $F_u$  is of finite codimension. In fact, by applying Theorem 5.8.4 to the trivial bundle  $1_{\mathbb{R}}: \mathbb{R} \rightarrow \mathbb{R}$  and noting Proposition 5.8.7, we may perturb any parameterized family so that each  $F_u$  is of finite singularity type at each of its critical points. The definition of  $f \in C^\infty(M, \mathbb{R})$  being of finite codimension, given below, is exactly equivalent to the algebraic condition given in (3.5) of Mather [45] for  $f$  to be finitely  $\mathcal{A}$ -determined at each of its critical points (as noted in [45], this part of (3.5) was first due to Tougeron [67], [68]). By Lemma 5.8.8, this is equivalent to  $f$  having finite singularity type at each of its critical points. We summarize this as

PROPOSITION 5.8.10. *A map  $f \in C^\infty(M, \mathbb{R})$  is of finite codimension if and only if it has finite singularity type at each of its critical points.*

We now recall material from Section 7 of [63]. Denote the smooth sections of a bundle  $E$  over  $M$  by  $\Gamma(E)$ . Until we reach Theorem 5.8.13, we will denote  $C^\infty(M, \mathbb{R})$  by  $C(M)$ . For a compact subset  $K \subset \mathbb{R}$ , define  $\text{Diff}_K(\mathbb{R})$  to be the diffeomorphisms of  $\mathbb{R}$  supported on  $K$ .

Fix an element  $f \in C(M)$  and a compact subset  $K \subset \mathbb{R}$  for which  $f(M)$  lies in the interior of  $K$ . Define  $\Phi: \text{Diff}(M) \times \text{Diff}_K(\mathbb{R}) \rightarrow C(M)$  by  $\Phi(\varphi_1, \varphi_2) = \varphi_2 \circ f \circ \varphi_1$ . The differential of  $\Phi$  at  $(1_M, 1_{\mathbb{R}})$  is defined by  $D(\xi_1, \xi_2) = f_*\xi_1 + \xi_2 \circ f$ . Here,  $\xi_1 \in \Gamma(TM)$ , which is regarded as the tangent space at  $1_M$  of  $\text{Diff}(M)$ ,  $\xi_2 \in \Gamma_K(T\mathbb{R})$ , similarly identified with the tangent space at  $1_{\mathbb{R}}$  of  $\text{Diff}_K(\mathbb{R})$ , and  $f_*\xi_1 + \xi_2 \circ f$  is regarded as an element of  $\Gamma(f^*T\mathbb{R})$ , which is identified with  $C(M)$ . The *codimension*  $\text{cdim}(f)$  of  $f$  is defined to be the real codimension of the image of  $D$  in  $C(M)$ . As will be seen shortly, the codimension of  $f$  tells the real codimension of the  $\text{Diff}(M) \times \text{Diff}_K(\mathbb{R})$ -orbit of  $f$  in  $C(M)$ .

Suppose that  $f$  has finite codimension  $c$ . In Section 7.2 of [63], a method is given for computing  $\text{cdim}(f)$  using the critical points of  $f$ . Fix a critical point  $a$  of  $f$ , with critical value  $f(a) = b$ . Consider  $D_a: \Gamma_a(TM) \times C_b(\mathbb{R}) \rightarrow C_a(M)$ , where a subscript as in  $\Gamma_a(TM)$  indicates the germs at  $a$  of  $\Gamma(TM)$ , and so on. Notice that the codimension of the image of  $D_a$  is finite, indeed it is at most  $c$ .

Let  $A$  denote the ideal  $f_*\Gamma_a(TM)$  of  $C_a(M)$ . This can be identified with the ideal in  $C_a(M)$  generated by the partial derivatives of  $f$ . An argument using Nakayama's Lemma [63, p. 645] shows that  $A$  has finite codimension in  $C_a(M)$ , and that some power of  $f(x) - f(a)$  lies in  $A$ . Define  $\text{cdim}(f, a)$  to be the dimension of  $C_a(M)/A$ , and  $\dim(f, a, b)$  to be the smallest  $k$  such that  $(f(x) - f(a))^k \in A$ .

Here is what these are measuring. The ideal  $A$  tells what local deformations of  $f$  at  $a$  can be achieved by precomposing  $f$  with a diffeomorphism of  $M$  (near  $1_M$ ), thus  $\text{cdim}(f, a)$  measures the codimension of the  $\text{Diff}(M)$ -orbit of the germ of  $f$  at  $a$ . The additional local deformations of  $f$  at  $a$  that can be achieved by postcomposing with a diffeomorphism of  $\mathbb{R}$  (again, near  $1_{\mathbb{R}}$ ) reduce the codimension by  $k$ , basically because Taylor's theorem shows that the germ at  $a$  of any  $\xi_2(f(x))$  can be written in terms of the powers  $(f(x) - f(a))^i$ ,  $i < k$ , plus a remainder of the form  $K(x)(f(x) - f(a))^k$ , which is an element of the ideal  $A$ . Thus  $\text{cdim}(f, a) - \dim(f, a, b)$  is the codimension of the image of  $D_a$ . For a noncritical point or a stable critical point such as  $f(x, y) = x^2 - y^2$  at  $(0, 0)$ , this local codimension is 0, but for unstable critical points it is positive.

Now, let  $\dim(f, b)$  be the maximum of  $\dim(f, a, b)$ , taken over the critical points  $a$  such that  $f(a) = b$  (put  $\dim(f, b) = 0$  if  $b$  is not a critical value). The codimension of  $f$  is then  $\sum_{a \in M} \text{cdim}(f, a) - \sum_{b \in \mathbb{R}} \dim(f, b)$ .

Here is what is happening at each of the finitely many critical values  $b$  of  $f$ . Let  $a_1, \dots, a_\ell$  be the critical points of  $f$  with  $f(a_i) = b$ ,

and for each  $i$  write  $f_i$  for the germ of  $f - f(a_i)$  at  $a_i$ . Consider the element  $(f_1, \dots, f_\ell) \in C_{a_1}(M)/A_1 \oplus \dots \oplus C_{a_\ell}(M)/A_\ell$ . The integer  $\dim(f, b)$  is the smallest power of  $(f_1, \dots, f_\ell)$  that is trivial in  $C_{a_1}(M)/A_1 \oplus \dots \oplus C_{a_\ell}(M)/A_\ell$ . The sum  $\sum_i \text{cdim}(f, a_i)$  counts how much codimension of  $f$  is produced by the inability to achieve local deformations of  $f$  near the  $a_i$  by precomposing with local diffeomorphisms at the  $a_i$ . This codimension is reduced by  $\dim(f, b)$ , because the germs of the additional deformations that can be achieved by postcomposition with diffeomorphisms of  $\mathbb{R}$  near  $b$  are the linear combinations of  $(1, \dots, 1)$ ,  $(f_1, \dots, f_\ell)$ ,  $(f_1^2, \dots, f_\ell^2), \dots, (f_1^{k-1}, \dots, f_\ell^{k-1})$ . Thus the contribution to the codimension from the critical points that map to  $b$  is  $\sum_i \text{cdim}(f, a_i) - \dim(f, b)$ , and summing over all critical values gives the codimension of  $f$ .

**5.8.5. The stratification of  $C^\infty(M, \mathbb{R})$  by codimension.** The functions whose codimension is finite and equal to  $n$  form the stratum  $\mathcal{F}_n$ . In particular,  $\mathcal{F}_0$  are the Morse functions,  $\mathcal{F}_1$  are the functions either having all critical points stable and exactly two with the same critical value, or having distinct critical values and all critical points stable except one which is a birth-death point. Moving to higher strata occurs either from more critical points sharing a critical value, or from the appearance of more singularities of positive but still finite local codimension.

We use the natural notations  $\mathcal{F}_{\geq n}$  for  $\cup_{i \geq n} \mathcal{F}_i$ ,  $\mathcal{F}_{> n}$  for  $\cup_{i > n} \mathcal{F}_i$ , and so on. In particular,  $\mathcal{F}_{\geq 0}$  is the set of all elements of  $C(M)$  of finite codimension, and  $\mathcal{F}_{> 0}$  is the set of all elements of finite codimension that are not Morse functions.

The main results of [63] (in particular, Theorem 8.1.1 and Theorem 9.2.4) show that the Sergeraert stratification is locally trivial, in the following sense.

**THEOREM 5.8.11 (Sergeraert).** *Suppose that  $f \in \mathcal{F}_n$ . Then there is a neighborhood  $V$  of  $f$  in  $C(M)$  of the form  $U \times \mathbb{R}^n$ , where*

- (1)  $U$  is a neighborhood of 1 in  $\text{Diff}(M) \times \text{Diff}_K(\mathbb{R})$ , and
- (2) there is a stratification  $\mathbb{R}^n = \cup_{i=0}^n F_i$ , such that  $\mathcal{F}_i \cap V = U \times F_i$ .

The inner workings of this result are as follows. Select elements  $f_1, \dots, f_n \in C(M)$  that represent a basis for the quotient of  $C(M)$  by the image of the differential  $D$  of  $\Phi$  at  $(1_M, 1_{\mathbb{R}})$ . For  $x = (x_1, \dots, x_n) \in \mathbb{R}^n$ , the function  $g_x = f + \sum_{i=1}^n x_i f_i$  is an element of  $C(M)$ . If the  $x_i$  are chosen in a sufficiently small ball around 0, which is again identified with  $\mathbb{R}^n$ , then these  $g_x$  form a copy  $E$  of  $\mathbb{R}^n$  “transverse” to the image of  $\Phi$ . Then,  $F_i$  is defined to be the intersection  $E \cap \mathcal{F}_i$ . A number

of subtle results on this local structure and its relation to the action of  $\text{Diff}(M) \times \text{Diff}_K(\mathbb{R})$  are obtained in [63], but we will only need the local structure we have described here.

We remark that  $F_n$  is not necessarily just  $\{0\} \in \mathbb{R}^n$ , that is, the orbit of  $f$  under  $\text{Diff}(M) \times \text{Diff}_K(\mathbb{R})$  might not fill up the stratum  $\mathcal{F}_n$  near  $f$ . This result, due to H. Hendriks [29], has been interpreted as saying that the Sergeraert stratification of  $C(M)$  is *not* locally trivial (a source of some confusion), or that it is “pathological” (which we find far too pejorative).

Denoting  $\cup_{i \geq 1} F_i$  by  $F_{\geq 1}$ , we have the following key technical result.

**PROPOSITION 5.8.12.** *For some coordinates on  $E$  as  $\mathbb{R}^n$ , there are a neighborhood  $L$  of 0 in  $\mathbb{R}^n$  and a nonzero polynomial  $p$  on  $\mathbb{R}^n$  such that  $p(L \cap F_{\geq 1}) = 0$ .*

**PROOF.** We will begin with a rough outline of the proof. Using Lemma 5.8.8, we may choose local coordinates at the critical points of  $f$  for which  $f$  is polynomial near each critical point. We will select the  $f_i$  in the construction of the transverse slice  $E = \mathbb{R}^n$  to be polynomial on these neighborhoods. Now  $F_{\geq 1}$  consists exactly of the choices of parameters  $x_i$  for which  $f + \sum x_i f_i$  is not a Morse function, since they are the intersection of  $E$  with  $\mathcal{F}_{\geq 1}$ . We will show that they form a semialgebraic set. But  $F_{\geq 1}$  has no interior, since otherwise (using Theorem 5.8.11) the subset of Morse functions  $\mathcal{F}_0$  would not be dense in  $C(M)$ . So Lemma 5.8.9 shows that  $F_{\geq 1}$  lies in the zero set of some nontrivial polynomial.

Now for the details. Recall that  $m$  denotes the dimension of  $M$ . Consider a single critical value  $b$ , and let  $a_1, \dots, a_\ell$  be the critical points with  $f(a_i) = b$ . Fix coordinate neighborhoods  $U_i$  of the  $a_i$  with disjoint closures, so that  $a_i$  is the origin 0 in  $U_i$ . By Lemma 5.8.8,  $f$  is finitely  $\mathcal{R}$ -determined near each critical point, so on each  $U_i$  there is a germ  $\varphi_i$  of a diffeomorphism at 0 so that  $f \circ \varphi_i$  is the germ of a polynomial. That is, by reducing the size of the  $U_i$  and changing the local coordinates, we may assume that on each  $U_i$ ,  $f$  is a polynomial  $p_i$ . As explained in Subsection 5.8.4, the contribution to the codimension of  $f$  from the  $a_i$  is the dimension of the quotient

$$Q_b = \left( \bigoplus_{i=1}^{\ell} C_{a_i}(U_i)/A_i \right) / B$$

where  $B$  is the vector subspace spanned by  $\{1, (p_1(x) - b), \dots, p_\ell(x) - b, \dots, ((p_1(x) - b)^{k-1}, \dots, (p_\ell(x) - b)^{k-1})\}$ . Choose  $q_{i,j}$ ,  $1 \leq j \leq n_i$ , where  $q_{i,j}$  is a polynomial on  $U_i$ , so that the germs of the  $q_{i,j}$  form a basis for  $Q_b$ . Fix vector spaces  $\Lambda_i \cong \mathbb{R}^{n_i} = \{(x_{i,1}, \dots, x_{i,n_i})\}$ ; these will eventually be some of the coordinates on  $E$ .



In each  $U_i$ , select round open balls  $V_i$  and  $W_i$  centered at 0 so that  $W_i \subset \overline{W_i} \subset V_i \subset \overline{V_i} \subset U_i$ . We select them small enough so that the closures in  $\mathbb{R}$  of their images under  $f$  do not contain any critical value except for  $b$ . Fix a smooth function  $\mu: M \rightarrow [0, 1]$  which is 1 on  $\cup \overline{W_i}$  and is 0 on  $M - \cup V_i$ , and put  $f_{i,j} = \mu \cdot q_{i,j}$ , a smooth function on all of  $M$ . Now choose a product  $L = \prod_i L_i$ , where each  $L_i$  is a round open ball centered at 0 in  $\Lambda_i$ , small enough so that if each  $(x_{i,1}, \dots, x_{i,n_i}) \in L_i$ , then each critical point of  $f + \sum x_{i,j} f_{i,j}$  either lies in  $\cup W_i$ , or is one of the original critical points of  $f$  lying outside of  $\cup U_i$ .

We repeat this process for each of the finitely many critical values of  $f$ , choosing additional  $W_i$  and  $L_i$  so small that all critical points of  $f + \sum x_{i,j} f_{i,j}$  lie in  $\cup W_i$ . That is, these perturbations of  $f$  are so small that each of the original critical points of  $f$  breaks up into critical points that lie very near the original one and far from the others.

The sum of all  $n_i$  is now  $n$ . We again use  $\ell$  for the number of  $U_i$ , and write  $\Lambda$  and  $L$  for the direct sum of all the  $\Lambda_i$  and the product of all the  $L_i$  respectively. For  $x \in L$ , write  $g_x = f + \sum x_{i,j} f_{i,j}$ . It remains to show that the set of  $x$  for which  $g_x$  is not a Morse function—that is, has a critical point with zero Hessian or has two critical points with the same value—is contained in a union of finitely many semialgebraic sets.

Denote elements of  $W_i$  by  $\overline{u_i} = (u_{i,1}, \dots, u_{i,m})$ , and similarly for elements  $\overline{x_i}$  of  $L_i$ . Define  $G_i: W_i \times L_i \rightarrow \mathbb{R}$  by  $G_i(\overline{u_i}, \overline{x_i}) = p_i(\overline{u_i}) + \sum_{j=1}^{n_i} x_{i,j} q_{i,j}(\overline{u_i})$ . Note that for  $x = (\overline{x_1}, \dots, \overline{x_\ell})$ ,  $(G_i)_{\overline{x_i}}$  is exactly the restriction of  $g_x$  to  $W_i$ .

We introduce one more notation that will be convenient. For  $X \subseteq L_i$  define  $E(X)$  to be the set of all  $(\overline{x_1}, \dots, \overline{x_\ell})$  in  $L$  such that  $\overline{x_i} \in X$ . When  $X$  is a semialgebraic subset of  $L_i$ ,  $E(X)$  is a semialgebraic subset of  $L$ . Similarly, if  $X \times Y \subseteq L_i \times L_j$ , we use  $E(X \times Y)$  to denote its extension to a subset of  $L$ , that is,  $E(X) \cap E(Y)$ .

For each  $i$ , let  $S_i$  be the set of all  $(\overline{u_i}, \overline{x_i})$  in  $W_i \times L_i$  such that  $\partial G_i / \partial u_{i,j}$  for  $1 \leq j \leq n_i$  all vanish at  $(\overline{u_i}, \overline{x_i})$ , that is, the pairs such that  $\overline{u_i}$  is a critical point of  $(G_i)_{\overline{x_i}}$ . Since  $S_i$  is the intersection of an algebraic set in  $\mathbb{R}^m \times \mathbb{R}^{n_i}$  with  $W_i \times L_i$ , and the latter are round open balls,  $S_i$  is semialgebraic. Let  $H_i$  be the set of all  $(\overline{u_i}, \overline{x_i})$  in  $W_i \times L_i$  such that the Hessian of  $(G_i)_{\overline{x_i}}$  vanishes at  $\overline{u_i}$ , again a semialgebraic set. The intersection  $H_i \cap S_i$  is the set of all  $(\overline{u_i}, \overline{x_i})$  such that  $(G_i)_{\overline{x_i}}$  has an unstable critical point at  $\overline{u_i}$ . By the Tarski-Seidenberg Theorem, its projection to  $L_i$  is a semialgebraic set, which we will denote by  $X_i$ . The union of the  $E(X_i)$ ,  $1 \leq i \leq \ell$ , is precisely the set of  $x$  in  $L$  such that  $g_x$  has an unstable critical point.

Now consider  $G_i \times G_i: S_i \times S_i - \Delta_i \rightarrow \mathbb{R}^2$ , where  $\Delta_i$  is the diagonal in  $S_i \times S_i$ . Let  $\widetilde{Y}_i = (G_i \times G_i)^{-1}(\Delta_{\mathbb{R}^2})$ , where  $\Delta_{\mathbb{R}^2}$  is the diagonal of  $\mathbb{R}^2$ . Now, let  $\Delta'_i$  be the set of all  $((\overline{u}_i, \overline{x}_i), (\overline{u}'_i, \overline{x}'_i))$  in  $W_i \times L_i \times W_i \times L_i$  such that  $\overline{x}_i = \overline{x}'_i$ . Then the projection of  $\widetilde{Y}_i \cap \Delta'_i$  to its first two coordinates is the set of all  $(\overline{u}_i, \overline{x}_i)$  in  $W_i \times L_i$  such that  $\overline{u}_i$  is a critical point of  $(G_i)_{\overline{x}_i}$  and  $(G_i)_{\overline{x}_i}$  has another critical point with the same value. The projection to the second coordinate alone is the set  $Y_i$  of  $\overline{x}_i$  for which  $(G_i)_{\overline{x}_i}$  has two critical points with the same value.

Finally, for  $i \neq j$ , consider  $G_i \times G_j: S_i \times S_j \rightarrow \mathbb{R}^2$  and let  $\widetilde{Y}_{i,j}$  be the inverse image of  $\Delta_{\mathbb{R}^2}$ . Let  $Y_{i,j}$  be the projection of  $\widetilde{Y}_{i,j}$  to a subset of  $L_i \times L_j$ . The union of the  $E(Y_i)$  and the  $E(Y_{i,j})$  is precisely the set of all  $x$  such that  $g_x$  has two critical points with the same value. Since these are semialgebraic sets, the proof is complete.  $\square$

Here is the main result of this subsection.

**THEOREM 5.8.13.** *Let  $M$  and  $W$  be compact smooth manifolds. Then for a residual set of smooth maps  $F$  from  $I \times W$  to  $C^\infty(M, \mathbb{R})$ , the following hold.*

- (i)  $F(I \times W) \subset \mathcal{F}_{\geq 0}$ .
- (ii) Each  $F_u^{-1}(\mathcal{F}_{>0})$  is finite.

**PROOF.** Start with a smooth map  $G: I \times W \rightarrow C^\infty(M, \mathbb{R})$ . Regarding it as a parameterized family of maps  $M \times (I \times W) \rightarrow \mathbb{R}$ , we apply Theorem 5.8.4 to perturb  $G$  so that each  $G_u$  is weakly transverse to the points of  $\mathbb{R}$ . By Proposition 5.8.10, this implies that  $G(I \times W) \subset \mathcal{F}_{\geq 0}$ . Since  $I \times W$  is compact,  $G(I \times W) \subset \mathcal{F}_{\leq n}$  for some  $n$ .

For each  $f \in \mathcal{F}_{>0}$ , choose a neighborhood  $V_f = U_f \times \mathbb{R}^n$  as in Theorem 5.8.11. Using Proposition 5.8.12, we may select a neighborhood  $L_f$  of 0 in  $\mathbb{R}^n$  and a nonzero polynomial  $p_f: L_f \rightarrow \mathbb{R}$  such that  $p_f(L \cap F_{i \geq 1}) = 0$ .

Now, partition  $I$  into subintervals and triangulate  $W$  so that for each subinterval  $J$  and each simplex  $\Delta$  of maximal dimension in the triangulation,  $G(J \times \Delta)$  lies either in  $\mathcal{F}_0$  or in some  $U_f \times L_f$ . Fix a particular  $J \times \Delta$ . If  $G(J \times \Delta)$  lies in  $\mathcal{F}_0$ , do nothing. If not, choose  $f$  so that  $G(J \times \Delta)$  lies in  $U_f \times L_f$ . Let  $\pi: U_f \times L_f \rightarrow L_f$  be the projection, so that  $p_f \circ \pi(U_f \times F_{\geq 1}) = 0$ . By Proposition 5.8.5, we may perturb  $G|_{J \times \Delta}$  (changing only its  $L_f$ -coordinate in  $U_f \times L_f$ ) so that for each  $u \in \Delta$ ,  $G_u|_J^{-1}(\mathcal{F}_{i \geq 1})$  is finite, and any map sufficiently close to  $G|_{J \times \Delta}$  on  $J \times \Delta$  will have this same property. As usual, of course, this is extended to a perturbation of  $G$ .

This process can be repeated sequentially on the remaining  $J \times \Delta$ . The perturbations must be so small that the property of having each  $G_u|_J^{-1}(\mathcal{F}_{i \geq 1})$  finite is not lost on previously considered sets. When all  $J \times \Delta$  have been considered, each  $G_u^{-1}(\mathcal{F}_{i \geq 1})$  is finite.  $\square$

**5.8.6. Border label control.** We now return to the case when  $M$  is a closed 3-manifold, as in the introduction of Section 5.8. In this subsection, we will obtain a deformation of  $f: M \times W \rightarrow M$  for which some  $\epsilon$  gives border label control.

We begin by ensuring that no  $f_u$  carries a component of the singular set  $T$  of  $\tau$  into  $T$ . Consider two circles  $C_1$  and  $C_2$  embedded in  $M$ . By Theorem 5.8.3, applied with  $A = C_1 \times W$ ,  $B = M$ , and  $C = C_2$ , we may perturb  $f|_{C_1 \times W}$  so that for each  $u \in W$ ,  $f_u|_{C_1}$  meets  $C_2$  in only finitely many points.

Recall that  $T$  consists of smooth circles and arcs in  $M$ . Each arc is part of some smoothly embedded circle, so  $T$  is contained in a union  $\cup_{i=1}^n C_i$  of embedded circles in  $M$ . By a sequence of perturbations as above, we may assume that at each  $u$ , each  $f_u(C_i)$  meets each  $C_j$  in a finite set (including when  $i = j$ ), so that  $f_u(T)$  meets  $T$  in a finite set.

The next potential problem is that at some  $u$ ,  $f_u(T_0)$  or  $f_u(T_1)$  might be contained in a single level  $P_t$ . Recall that the notation  $R(s, t)$ , introduced in Section 5.5, means  $\tau^{-1}([s, t])$ . For some  $\delta > 0$ , every  $f_u(T_0)$  meets  $R(3\delta, 1-3\delta)$ , since otherwise the compactness of  $W$  would lead to a parameter  $u$  for which  $f_u(T_0) \subset T$ . Let  $\phi: R(\delta, 1-\delta) \rightarrow [\delta, 1-\delta]$  be the restriction of the map  $\pi(\tau(x, t)) = t$ . This  $\phi$  makes  $R(\delta, 1-\delta)$  a bundle with fibers that are level tori. As before, let  $C_1$  be one of the circles whose union contains  $T$ . Only the most superficial changes are needed to the proof of Theorem 5.8.4 given in [8] so that it applies when  $\phi$  is a bundle map defined on a codimension-zero submanifold of  $B$  rather than on all of  $B$ ; the only difference is that the subsets of jets which are to be avoided are defined only at points of the subspace rather than at every point of  $B$ . Using this slight generalization of Theorem 5.8.4 (and as usual, the Parameterized Extension Principle), we perturb  $f$  so that each  $f_u|_{C_1}$  is weakly transverse to each  $P_t$  with  $\delta \leq t \leq 1-\delta$ . Since  $C_1$  is 1-dimensional, weakly transverse implies that  $f_u(C_1)$  meets each such  $P_t$  in only finitely many points. Repeating for the other  $C_i$ , we may assume that each  $f_u(T_0)$  meets the  $P_t$  with  $\delta \leq t \leq 1-\delta$  in only finitely many points. We also choose the perturbations small enough so that each  $f_u(T_0)$  still meets  $R(2\delta, 1-2\delta)$ . So  $f_u^{-1}(P_t) \cap T_0$  is nonempty and finite at least some  $t$ . In particular,  $\pi(f_u(T_0))$  contains an open set, so by Sard's Theorem applied to  $\pi \circ f_u|_{T_0}$ , for each  $u$ , there is an  $r$  so that  $f_u(T_0)$  meets  $P_r$  transversely in a nonempty set (we select  $r$  so that  $P_r$  does not contain the image of a vertex of  $T_0$ ). For a small enough  $\epsilon$ , a component of  $X_s \cap P_r$  will be a compressing disk of  $X_s$  whenever  $s \leq 2\epsilon$ , and by compactness of  $W$ , there is an  $\epsilon$  such that for every  $u$ , there is a level  $P_r$  such that some component of  $X_s \cap P_r$  contains a compressing disk of  $X_s$  whenever  $s \leq 2\epsilon$ .

Applying the same procedure to  $T_1$ , we may assume that for every  $u$ , there there is a level  $P_r$  such that some component of  $Y_s \cap P_r$  is a compressing disk of  $Y_s$  whenever  $s \geq 1 - 2\epsilon$ .

Let  $h: M \times W \rightarrow M$  be defined by  $h(x, u) = f_u^{-1}(x)$ . Fix new sweepouts on the  $M \times \{u\}$ , given by  $f_u \circ \tau$ , so that  $h_u$  carries the levels of this sweepout to the original  $P_t$ . Applying the previous procedure to  $h$ , making sure that all perturbations are small enough to preserve the conditions developed for  $f$ , and perhaps making  $\epsilon$  smaller, we may assume that for each  $u$ , there is a level  $Q_r$  such that  $V_t \cap Q_r$  is a compressing disk of  $V_t$  whenever  $t \leq 2\epsilon$ , and a similar  $Q_r$  for  $W_t$  with  $t \geq 1 - 2\epsilon$ . Thus the number  $\epsilon$  gives border label control for  $f$ . Since border label control holds, with the same  $\epsilon$ , for any map sufficiently close to  $f$ , we may assume it is preserved by all future perturbations.

**5.8.7. Building the graphics.** It remains to deform  $f$  to satisfy conditions (GP1), (GP2), and (GP3). As before, let  $i: I \rightarrow \mathbb{R}$  be the inclusion, and consider the smooth map  $i \circ \pi \circ f \circ (\tau \times 1_W): P \times I \times W \rightarrow \mathbb{R}$ . Regard this as a family of maps from  $I$  to  $C^\infty(P, \mathbb{R})$ , parameterized by  $W$ . Apply Theorem 5.8.13 to obtain a family  $k: P \times I \times W \rightarrow \mathbb{R}$ . For each  $I \times \{u\}$ , there will be only finitely many values of  $s$  in  $I$  for which the restriction  $k_{(s,u)}$  of  $k$  to  $P \times \{s\} \times \{u\}$  is not a Morse function. At these levels, the projection from  $Q_s$  into the transverse direction to  $P_t$  is an element of some  $\mathcal{F}_n$ , so each tangency of  $Q_s$  with  $P_t$  looks like the graph of a critical point of finite multiplicity. This will ultimately ensure that condition (GP1) is attained when we complete our deformations of  $f$ .

We will use  $k$  to obtain a deformation of the original  $f$ , by moving image points vertically with respect to the levels of the range. This would not make sense where the values of  $k$  fall outside  $(0, 1)$ , so the motion will be tapered off so as not to change  $f$  at points that map near  $T$ . It also would not be well-defined at points of  $T \times W$ , so we taper off the deformation so as not to change  $f$  near  $T \times W$ . The fact that  $f$  is unchanged near  $T \times W$  and near points that map to  $T$  will not matter, since border label control will allow us to ignore these regions in our later work.

Regard  $P \times I \times W$  as a subspace of  $P \times \mathbb{R} \times W$ . For each  $(x, r, u) \in P \times I \times W$ , let  $w'_{(x,r,u)}$  be  $k(x, r, u) - i \circ \pi \circ f_u \circ \tau(x, r)$ , regarded as a tangent vector to  $\mathbb{R}$  at  $i \circ \pi \circ f_u \circ \tau(x, r)$ .

We will taper off the  $w'_{(x,r,u)}$  so that for each fixed  $u$  they will produce a vector field on  $M$ . Fix a number  $\epsilon$  that gives border label control for  $f$ , and a smooth function  $\mu: \mathbb{R} \rightarrow I$  which carries  $(-\infty, \epsilon/4] \cup [1 - \epsilon/4, \infty)$  to 0 and carries  $[\epsilon/2, 1 - \epsilon/2]$  to 1. Define

$w_{(x,r,u)}$  to be  $\mu(r) \mu(i \circ \pi \circ f_u \circ \tau(x, r)) w'_{(x,r,u)}$ . These vectors vanish whenever  $r \notin [\epsilon/4, 1 - \epsilon/4]$  or  $i \circ \pi \circ f_u \circ \tau(x, r, u) \notin [\epsilon/4, 1 - \epsilon/4]$ , that is, whenever  $\tau(x, r)$  or  $f_u \circ \tau(x, r)$  is close to  $T$ . Using the map  $i \circ \pi: M \rightarrow \mathbb{R}$ , we pull the  $w_{(x,r,u)}$  back to vectors in  $M$  that are perpendicular to  $P_t$ ; this makes sense near  $T$  since the  $w_{(x,r,u)}$  are zero at these points). For each  $u$ , we obtain at each point  $f_u \circ \tau(x, r) \in M$  a vector  $v_{(x,r,u)}$  that points in the I-direction (i. e. is perpendicular to  $P_t$ ) and maps to  $w_{(x,r,u)}$  under  $(i \circ \pi)_*$ .

If  $k$  was a sufficiently small perturbation, the  $v_{(x,r,u)}$  define a smooth map  $j_u: M \rightarrow M$  by  $j_u(\tau(x, r)) = \text{Exp}(v_{(x,r,u)})$ . Put  $g_u = j_u \circ f_u$ . Since  $\mu(r) = 1$  for  $\epsilon/2 \leq r \leq 1 - \epsilon/2$ , we have  $i \circ \pi \circ g_u \circ \tau(x, r) = k(x, r, u)$  whenever both  $\epsilon/2 \leq r \leq 1 - \epsilon/2$  and  $\epsilon/2 \leq i \circ \pi \circ f_u \circ \tau(x, r) \leq 1 - \epsilon/2$ . The latter condition says that  $f_u \circ \tau(x, r)$  is in  $P_s$  for some  $\epsilon/2 \leq s \leq 1 - \epsilon/2$ . Assuming that  $k$  was close enough to  $i \circ \pi \circ f \circ (\tau \times 1_W)$  so that each  $\pi \circ g_u \circ \tau(x, r)$  is within  $\epsilon/4$  of  $\pi \circ f_u \circ \tau(x, r)$ , the equality  $i \circ \pi \circ g_u \circ \tau(x, r) = k(x, r, u)$  holds whenever  $\tau(x, r)$  is in a  $P_s$  and  $g_u \circ \tau(x, r)$  is in a  $P_t$  with  $\epsilon \leq s, t \leq 1 - \epsilon$ .

Carrying out this construction for a sequence of  $k$  that converge to  $i \circ \pi \circ f \circ (\tau \times 1_W)$ , we obtain vector fields  $v_{(x,r,u)}$  that converge to the zero vector field. For those sufficiently close to zero,  $g$  will be a deformation of  $f$ . Choosing  $g$  sufficiently close to  $f$ , we may ensure that  $\epsilon$  still gives border label control for  $g$ .

We will now analyze the graphic of  $g_u$  on  $I_\epsilon^2$ . For  $s, t \in [\epsilon, 1 - \epsilon]$ ,  $\pi \circ g_u(x)$  equals  $k_{(s,u)}(x)$  whenever  $x \in P_s$  and  $g_u(x) \in P_t$ . Therefore the tangencies of  $g_u(P_s)$  with  $P_t$  are locally just the graphs of critical points of  $k_{(s,u)}: P \rightarrow \mathbb{R}$ , so  $g$  has property (GP1).

Let  $s_1, \dots, s_n$ , be the values of  $s$  in  $[\epsilon, 1 - \epsilon]$  for which  $k_{(s_i,u)}: P \rightarrow \mathbb{R}$  is not a Morse function. Each  $k_{(s_i,u)}$  is still a function of finite codimension, so has finitely many critical points. Those critical points having critical values in  $[\epsilon, 1 - \epsilon]$  produce the points of the graphic of  $g_u$  that lie in the vertical line  $s = s_i$ , as suggested in Figure 5.8. We declare the  $(s_i, t)$  at which  $k_{(s_i,u)}$  has a critical point at  $t$  to be vertices of  $\Gamma_u$ .

When  $s$  is not one of the  $s_i$ ,  $k_{(s,u)}$  is a Morse function, so any tangency of  $g_u(P_s)$  with  $P_t$  is stable, and there is at most one such tangency. Since these tangencies are stable, all nearby tangencies are equivalent to them and hence also stable, so in the graphic for  $g_u$  in  $I_\epsilon^2$ , the pairs  $(s, t)$  corresponding to levels with a single stable tangency form ascending and descending arcs as suggested in Figure 5.8. These arcs may enter or leave  $I_\epsilon^2$ , or may end at a point corresponding to one of the finitely many points of the graphic with  $s$ -coordinate equal

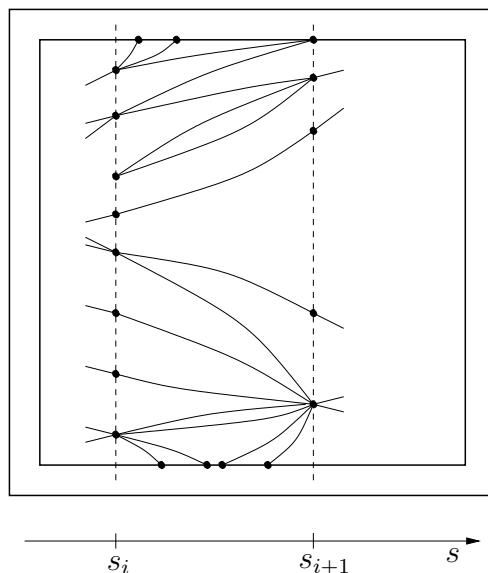

FIGURE 5.8. A portion of the graphic of  $g_u$ .

to one of the  $s_i$ . We declare the intersection points of these arcs with  $\partial I_\epsilon$  to be vertices of  $\Gamma_u$ . The conditions (GP2) and (GP3) have been achieved, completing the proof of Theorem 5.8.2.

### 5.9. Finding good regions

In this section, we adapt the arguments of Section 5.6 to general position families. The graphics associated to the  $f_u$  of a general position family  $f: M \times W \rightarrow M$  satisfy property (RS1) of Section 5.6 (provided that the Heegaard splittings associated to the sweepout are strongly irreducible) and property (RS2) (since the open edges of the  $\Gamma$  correspond to pairs of levels that have a single stable tangency, see the remark after the definition of (RS2) in Section 5.6), but not property (RS3). Indeed, property (RS3) does not even make sense, since the vertices of  $\Gamma$  can have high valence. Property (RS1) is what allows the map from the 0-cells of  $K$  to the 0-simplices of the Diagram to be defined. Property (RS2) (plus conditions on regions near  $\partial K$ , which we will still have due to border label control) allows it to be extended to a cellular map from the 1-skeleton of  $K$  to the 1-skeleton of the Diagram. What ensures that it still extends to the 2-cells is a topological fact about pairs of levels whose intersection contains a common spine, Lemma 5.9.2. Because it involves surfaces that do not meet transversely, its proof is complicated and somewhat delicate. Since the proof does not introduce any ideas needed elsewhere, the reader may

wish to skip it on a first reading, and go directly from the statement of Lemma 5.9.2 to the last four paragraphs of the section.

We specialize to the case of a parameterized family  $f: L \times W \rightarrow L$ , where  $L$  is a lens space and  $W$  is a compact manifold. We retain the notations  $P_t$ ,  $Q_s$ ,  $V_t$ ,  $W_t$ ,  $X_s$ , and  $Y_s$  of Section 5.8. As was mentioned above, properties (RS1) and (RS2) already hold for the labels of the regions of the graphic of each  $f_u$ .

**THEOREM 5.9.1.** *Suppose that  $f: L \times W \rightarrow L$  is in general position with respect to  $\tau$ . Then for each  $u$ , there exists  $(s, t)$  such that  $Q_s$  meets  $P_t$  in good position.*

The proof of Theorem 5.9.1 will constitute the remainder of this section.

We first prove a key geometric lemma that is particular to lens spaces.

**LEMMA 5.9.2.** *Let  $f: L \times W \rightarrow L$  be a parameterized family of diffeomorphisms in general position, and let  $(s, t) \in I_c^2$ . If  $Q_s \cap P_t$  contains a spine of  $P_t$ , then either  $V_t$  or  $W_t$  contains a core circle which is disjoint from  $Q_s$ .*

**PROOF.** We will move  $Q_s$  by a sequence of isotopies of  $L$ . All isotopies will have the property that if  $V_t - Q_s$  (or  $W_t - Q_s$ ) did not contain a core circle of  $V_t$  (or  $W_t$ ) before the isotopy, then the same is true after the isotopy. We say this succinctly with the phrase that the isotopy *does not create core circles*. Typically some of the isotopies will not be smooth, so we work in the PL category. At the end of an initial “flattening” isotopy,  $Q_s$  will intersect  $P_t$  nontransversely in a 2-dimensional simplicial complex  $X$  in  $P_t$  whose frontier consists of points where  $Q_s$  is PL embedded but not smoothly embedded. A sequence of simplifications called tunnel moves and bigon moves, plus isotopies that push disks across balls, will make  $Q_s \cap P_t$  a single component  $X_0$ , which will then undergo a few additional improvements. After this has been completed, an Euler characteristic calculation will show that a core circle disjoint from the repositioned  $Q_s$  exists in either  $V_t$  or  $W_t$ , and consequently one existed for the original  $Q_s$ .

The first step is to perform a so-called “flattening” isotopy. Such isotopies were already described in detail in Lemma 4.6.3, but we will give a self-contained construction here.

Since  $f$  is in general position,  $Q_s \cap P_t$  is a 1-complex satisfying the property (GP1) of Section 5.8. Each isolated vertex of  $Q_s \cap P_t$  is an isolated tangency of  $Q_s \cap P_t$ , so we can move  $Q_s$  by a small isotopy near the vertex to eliminate it from the intersection. After this step,

$Q_s \cap P_t$  is a graph  $\Gamma$  which contains a spine of  $Q_s \cap P_t$ , such that each vertex of  $\Gamma$  has positive valence.

By property (GP1), each vertex  $x$  of  $\Gamma$  is a point where  $Q_s$  is tangent to  $P_t$ , and the edges of  $\Gamma$  that emanate from  $x$  are arcs where  $Q_s$  intersects  $P_t$  transversely. Along each arc,  $Q_s$  crosses from  $V_t$  into  $W_t$  or vice versa, so there is an even number of these arcs. Near  $x$ , the tangent planes of  $Q_s$  are nearly parallel to those of  $P_t$ , and there is an isotopy that moves a small disk neighborhood of  $x$  in  $Q_s$  until it coincides with a small disk neighborhood of  $x$  in  $P_t$ . Perform such isotopies near each vertex of  $\Gamma$ . This enlarges  $\Gamma$  in  $Q_s \cap P_t$  to the union of  $\Gamma$  with a union  $E$  of disks, each disk containing one of the original vertices.

The closure of the portion of  $\Gamma$  that is not in  $E$  now consists of a collection of arcs and circles where  $Q_s$  intersects  $P_t$  transversely, except at the endpoints of the arcs, which lie in  $E$ . Consider one of these arcs,  $\alpha$ . At points of  $\alpha$  near  $E$ , the tangent planes to  $Q_s$  are nearly parallel to those of  $P_t$ , and starting from each end there is an isotopy that moves a small regular neighborhood of a portion of  $\alpha$  in  $Q_s$  onto a small regular neighborhood of the same portion of  $\alpha$  in  $P_t$ . This flattening process can be continued along  $\alpha$ . If it is started from both ends of  $\alpha$ , it may be possible to flatten all of a regular neighborhood of  $\alpha$  in  $Q_s$  onto one in  $P_t$ . This occurs when the vectors in a field of normal vectors to  $\alpha$  in  $Q_s$  are being moved to normal vectors on the same side of  $\alpha$  in  $P_t$ . If they are being moved to opposite sides, then we introduce a point where the configuration is as in Figure 4.1, in which  $P_t$  appears as the  $xy$ -plane,  $\alpha$  appears as the points in  $P_t$  with  $x = -y$ , and  $Q_s$  appears as the four shaded half- or quarter-planes. These points will be called *crossover* points. Perform such isotopies in disjoint neighborhoods of all the arcs of  $\Gamma - E$ . For the components of  $\Gamma$  that are circles of transverse intersection points, we flatten  $Q_s$  near each circle to enlarge the intersection component to an annulus.

At the end of this initial process,  $\Gamma$  has been enlarged to a 2-complex  $X$  in  $Q_s \cap P_t$  that is a regular neighborhood of  $\Gamma$ , except at the crossover points where  $\Gamma$  and  $X$  look locally like the antidiagonal  $x = -y$  of the  $xy$ -plane and the set of points with  $xy \leq 0$ . We will refer to  $X$  as a *pinched regular neighborhood* of  $\Gamma$ .

Since  $\Gamma$  originally contained a spine of  $P_t$ ,  $X$  contains two circles that meet transversely in one point that lies in the interior (in  $P_t$ ) of  $X$ . Therefore  $X$  contains a common spine of  $P_t$  and  $Q_s$ . Let  $X_0$  be the component of  $X$  that contains a common spine of  $Q_s$  and  $P_t$ . All components of  $P_t - X_0$  and  $Q_s - X_0$  are open disks. Let  $X_1 = X - X_0$ , and for each  $i$ , denote  $\Gamma \cap X_i$  by  $\Gamma_i$ .



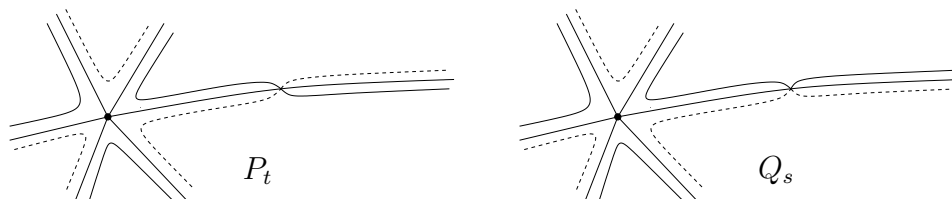

FIGURE 5.9. Up and down edges of  $X$  as they appear in  $P_t$  and  $Q_s$ .

The next step will be to move  $Q_s$  by isotopy to remove  $X_1$  from  $Q_s \cap P_t$ . These isotopies will be fixed near  $X_0$ . Some of them will have the effect of joining two components of  $V_t - Q_s$  (or of  $W_t - Q_s$ ) into a single component of  $V_t - Q_s$  (or of  $W_t - Q_s$ ) for the repositioned  $Q_s$ , so we must be very careful not to create core circles.

The frontier of  $X_1$  in  $P_t$  is a graph  $\text{Fr}(X_1)$  for which each vertex is a crossover point, and has valence 4 (as usual, our “graphs” can have open edges that are circles). Its edges are of two types: *up* edges, for which the component of  $\overline{Q_s - X}$  that contains the edge lies in  $W_t$ , and *down* edges, for which it lies in  $V_t$ . At each disk of  $E$ , the up and down edges alternate as one moves around  $\partial E$  (see Figure 5.9). For each of the arcs of  $\Gamma_1 - E$ , the flattening process creates an up edge on one side and a down edge on the other, but there is a fundamental difference in the way that the up and down edges appear in  $Q_s$  and  $P_t$ . As shown in Figure 5.9, up edges (the solid ones) and down edges (the dotted ones) alternate as one moves around a crossover point, while in  $Q_s$  they occur in adjacent pairs. This is immediate upon examination of Figure 4.1.

For our inductive procedure, we start with a pinched regular neighborhood  $X_1 \subset Q_s \cap P_t$  of a graph  $\Gamma_1$  in  $Q_s \cap P_t$ , all of whose vertices have positive even valence. Moreover, the edges of the frontier of  $X_1$  are up or down according to whether the portion of  $\overline{Q_s - X}$  that contains them lies in  $W_t$  or  $V_t$ . We call this an *inductive configuration*.

To ensure that our isotopy process will terminate, we use the complexity  $-\chi(\Gamma_1) - \chi(\text{Fr}(X_1)) + N$ , where  $N$  is the number of components of  $\Gamma_1$ . Since all vertices of  $\Gamma_1$  and  $\text{Fr}(X_1)$  have valence at least 2, each of their components has nonpositive Euler characteristic, so the complexity is a non-negative integer. The remaining isotopies will reduce this complexity, so our procedure must terminate.

We may assume that the complexity is nonzero, since if  $N = 0$  then  $X_1$  is empty. Consider  $X_1$  as a subset of the union of open disks  $Q_s - X_0$ . Since  $X_1$  is a pinched regular neighborhood of a graph with vertices of valence at least 2, it separates these disks, and we can find

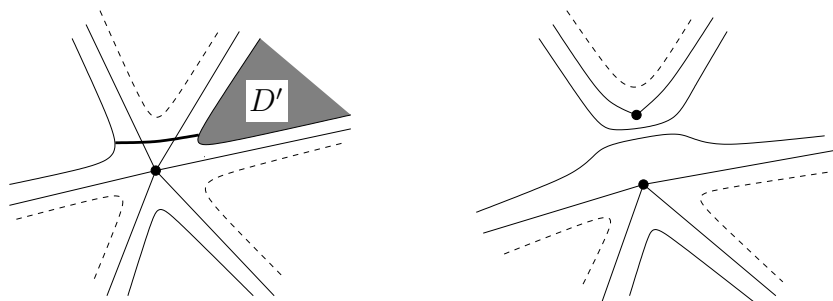

FIGURE 5.10. A portion of  $P_t$  showing a tunnel arc in  $X_1$ , and the new  $\Gamma_1$  and  $X_1$  after the tunnel move.

a closed disk  $D$  in  $Q_s$  with  $\partial D \subset X_1$  and  $D \cap X = \partial D$ . It lies either in  $V_t$  or  $W_t$ . Assume it is in  $W_t$  (the case of  $V_t$  is similar), in which case all of its edges are up edges. Since  $\partial D \subset P_t - X_0$ ,  $\partial D$  bounds a disk  $D'$  in  $P_t - X_0$ . Since the interior of  $D$  is disjoint from  $P_t$ ,  $D \cup D'$  bounds a 3-ball  $\Sigma$  in  $L$ . Of course,  $D'$  may contain portions of the component of  $X_1$  that contains  $\partial D'$ , or other components of  $X_1$ . Let  $X'_1$  be the component of  $X_1$  that contains  $\partial D'$ ; it is a pinched regular neighborhood of a component  $\Gamma'_1$  of  $\Gamma$ .

Suppose that  $X'_1$  contains some vertices of  $\Gamma_1$  of valence more than 2. We will perform an isotopy of  $Q_s$  that we call a *tunnel move*, illustrated in Figure 5.10, that reduces the complexity of the inductive configuration. Near the vertex, select an arc in  $X'_1$  that connects the edge of  $\text{Fr}(X'_1)$  in  $D'$  with another up edge of  $\text{Fr}(X'_1)$  that lies near the vertex (this arc may lie in  $D'$ , in a portion of  $X_1$  contained in  $D'$ ). An isotopy of  $Q_s$  is performed near this arc, that pulls an open regular neighborhood of the arc in  $X'_1$  into  $W_t$ . This does not change the interior of  $V_t - Q_s$  (it just adds the regular neighborhood of the arc to  $V_t - Q_s$ ), but in  $W_t$  it creates a tunnel that joins two different components of  $W_t - Q_s$ . One of these components was in  $\Sigma$ , so the isotopy cannot create core circles. After the tunnel move, we have a new inductive configuration. The Euler characteristic of  $\Gamma_1$  has been increased by the addition of one vertex, while  $\chi(\text{Fr}(X_1))$  and  $N$  are unchanged, so the new inductive configuration is of lower complexity. The procedure continues by finding a new  $D$  and  $D'$  and repeating the process.

When a  $D$  has been found for which no tunnel moves are possible, all vertices of  $\Gamma'_1$  (if any) have valence 2. Suppose that  $X'_1$  contains crossover points. It must contain an even number of them, since up and down edges at crossover points alternate in  $P_t$ . Some portion of  $X'_1$  is a disk  $B$  whose frontier consists of two crossover points and two

edges of  $\text{Fr}(X_1)$ , each connecting the two crossover points. We will use a *bigon move* as in the proof of Proposition 4.6.2. A bigon move is an isotopy of  $Q_s$ , supported in a neighborhood of  $B$ , that repositions  $Q_s$  and replaces a neighborhood of  $B$  in  $X$  with a rectangle containing no crossover points. Figure 4.4 illustrates this isotopy. It cannot create core circles, indeed such an isotopy changes the interiors of  $V_t - Q_s$  and  $W_t - Q_s$  only by homeomorphism.

Since bigon moves increase the Euler characteristic of  $\text{Fr}(X_1)$ , without changing  $\Gamma_1$  or  $N$ , they reduce complexity. So we eventually arrive at the case when  $X'_1$  is an annulus. Assume for now that the interior of  $D'$  is disjoint from  $X_1$ . There is an isotopy of  $Q_s$  that pushes  $D$  across  $\Sigma$ , until it coincides with  $D'$ . This cannot create core circles, since its effect on the homeomorphism type of  $W_t - Q_s$  is simply to remove the component  $\Sigma - Q_s$ . Perform a small isotopy that pulls  $D'$  off into the interior of  $V_t$ , again creating no new core circles. An annulus component of  $X_1$  has been eliminated, reducing the complexity. If  $D' \cap X_1 = X'_1$ , then a similar isotopy eliminates  $X'_1$ .

Suppose now that the interior of  $D'$  contains components of  $X_1$  other than perhaps  $X'_1$ . Let  $X''_1$  be their union. It is a pinched regular neighborhood of a union  $\Gamma''_1$  of components of  $\Gamma_1$ . If  $\Gamma''_1$  has vertices of valence more than 2, then tunnel moves can be performed. These cannot create new core circles, since they do not change the interior of  $V_t - Q_s$ , and in  $W_t - Q_s$  they only connect regions that are contained in  $\Sigma$ . If no tunnel move is possible, but there are crossover points, then a bigon move may be performed. So we may assume that every component of  $X''_1$  is an annulus.

Let  $S$  be a boundary circle of  $X''_1$  innermost on  $D'$ , bounding a disk  $D''$  in  $D'$  whose interior is disjoint from  $X$ . Let  $E''$  be the disk in  $Q_s$  bounded by  $S$ , so that  $D'' \cup E''$  bounds a 3-ball  $\Sigma''$  in  $L$ . Note that  $E''$  does not contain  $X_0$ , since then a spine of  $P_t$  would be contained in the 2-sphere  $E'' \cup D''$ .

We claim that if  $(V_t - Q_s) \cup (E'' \cap V_t)$  contains a core circle of  $V_t$ , then  $V_t - Q_s$  contained a core circle of  $V_t$  (and analogously for  $W_t$ ). The closures of the components of  $E'' - P_t$  are planar surfaces, each lying either in  $V_t$  or  $W_t$ . Let  $F$  be one of these, lying (say) in  $V_t$ . Its boundary circles lie in  $P_t - X_0$ , so bound disks in  $P_t$ . The union of  $F$  with these disks is homotopy equivalent to  $S^2 \vee (\vee S^1)$  for some possibly empty collection of circles, so a regular neighborhood in  $V_t$  of the union of  $F$  with these disks is a punctured handlebody  $Z(F)$  meeting  $P_t$  in a union of disks. Suppose that  $C$  is a core circle in  $V_t$  that is disjoint from  $Q_s - F$ . We may assume that  $C$  meets  $\partial Z(F)$  transversely, so cuts through  $Z(F)$  is a collection of arcs. Since  $Z(F)$  is handlebody

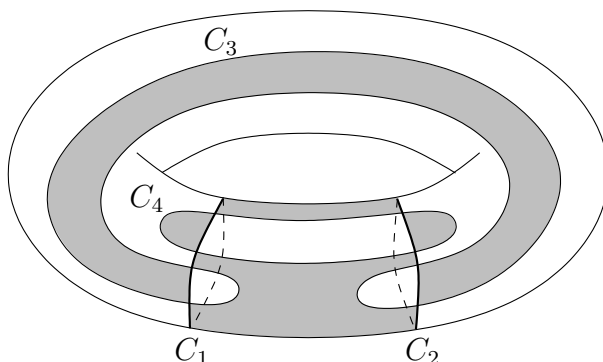

FIGURE 5.11. A flattened torus containing two meridian disks.

meeting  $P_t$  only in disks, there is an isotopy of  $C$  that pushes the arcs to the frontier of  $Z(F)$  in  $V_t$  and across it, removing the intersections of  $C$  with  $F$  without creating new intersections (since the arcs need only be pushed slightly outside of  $Z(F)$ ). Performing such isotopies for all components of  $E'' - X_1$  in  $V_t$  produces a core circle disjoint from  $E''$ , proving the claim.

By virtue of the claim, an isotopy that pushes  $E''$  across  $\Sigma''$  until it coincides with  $D''$  does not create core circles. Then, a slight additional isotopy pulls  $D''$  and the component of  $X_1$  that contained  $\partial D''$  off of  $P_t$ , reducing the complexity.

Since we can always reduce a nonzero complexity by one of these isotopies, we may assume that  $Q_s \cap P_t = X_0$ . The frontier  $\text{Fr}(X_0)$  in  $P_t$  is the union of a graph  $\Gamma_2$ , each of whose components has vertices of valence 4 corresponding to crossover points, and a graph  $\Gamma_3$  whose components are circles.

A component of  $\Gamma_3$  must bound both a disk  $D_Q$  in  $\overline{Q_s - X_0}$  and a disk  $D_P$  in  $\overline{P_t - X_0}$ . Since  $Q_s \cap P_t = X_0$ , the interiors of  $D_P$  and  $D_Q$  are disjoint, and  $D_Q$  lies either in  $V_t$  or in  $W_t$ . So we may push  $D_Q$  across the 3-ball bounded by  $D_Q \cup D_P$  and onto  $D_P$ , without creating core circles. Repeating this procedure to eliminate the other components of  $\Gamma_3$ , we achieve that the frontier of  $Q_s \cap P_t$  equals the graph  $\Gamma_2$ .

Figure 5.11 shows a possible intersection of  $Q_s$  with  $P_t$  at this stage. The shaded region is  $Q_s \cap P_t$ ; it is a union of a (solid) octagon, two bigons, and a square. The closure of  $Q_s - (Q_s \cap P_t)$  consists of two meridian disks in  $V_t$ , bounded by the circles  $C_1$  and  $C_2$ , and two boundary-parallel disks in  $W_t$ , bounded by the circles  $C_3$  and  $C_4$ .

Suppose that  $Q_s$  now contains  $2k_1$  meridian disks of  $Q_s$  in  $V_t$  and  $2k_2$  meridian disks in  $W_t$  (their numbers must be even since  $Q_s$  is zero in  $H_2(L)$ ), and a total of  $k_0$  boundary-parallel disks in  $V_t$  and  $W_t$ . Since

$\chi(Q_s) = 0$ , we have  $\chi(Q_s \cap P_t) = -k_0 - 2k_1 - 2k_2$ . To prove the lemma, we must show that either  $k_1$  or  $k_2$  is 0.

Let  $V$  be the number of vertices of  $\Gamma_2$ . Since all of its vertices have valence 4,  $\Gamma_2$  has  $2V$  edges. The remainder of  $Q_s \cap P_t$  consists of 2-dimensional faces. Each of these faces has boundary consisting of an even number of edges, since up and down edges alternate around a face. If some of the faces are bigons, such as two of the faces in Figure 5.11, they may be eliminated by bigon moves (which will also change  $V$ ). These may create additional components of the frontier of  $X_0$  that are circles, indeed this happens in the example of Figure 5.11. These are eliminated as before by moving disks of  $Q_s$  onto disks in  $P_t$ . After all bigons have been eliminated, each face has at least four edges, so there are at most  $V/2$  faces. So we have  $\chi(Q_s \cap P_t) \leq V - 2V + V/2 = -V/2$ .

Each boundary-parallel disk in  $Q_s \cap V_t$  or  $Q_s \cap W_t$  contributes at least two vertices to the graph, since at each crossover point,  $X_0$  crosses over to the other side in  $P_t$  of the boundary of the disk. This gives at least  $2k_0$  vertices. The meridian disks on the two sides contribute at least  $2k_1 \cdot 2k_2 \cdot m$  additional vertices, where  $L = L(m, q)$ , since the meridians of  $V_t$  and  $W_t$  have algebraic intersection  $\pm m$  in  $P_t$ . Thus  $V \geq 2k_0 + 4k_1k_2m$ . We calculate:

$$-k_0 - 2k_1 - 2k_2 = \chi(Q_s \cap P_t) \leq -V/2 \leq -k_0 - 2k_1k_2m .$$

Since  $m > 2$ , this can hold only when either  $k_1$  or  $k_2$  is 0. □

Lemma 5.9.2 fails (at the last sentence of the proof) for the case of  $L(2, 1)$ . Indeed, there is a flattened Heegaard torus in  $L(2, 1)$  which meets  $P_{1/2}$  in four squares and has two meridian disks on each side. In a sketch somewhat like that of Figure 5.11, the boundaries of these disks are two meridian circles and two  $(2, 1)$ -loops intersecting in a total of 8 points, and cutting the torus into 8 squares. There are two choices of four of these squares to form  $Q_s \cap P_t$ .

Now, we will complete the proof of Theorem 5.9.1. As in Section 5.6, assume for contradiction that all regions are labeled, and triangulate  $I_\epsilon^2$ . The map on the 1-skeleton is defined exactly as in Section 5.6, using Lemma 5.8.1 and the fact that the labels satisfy property (RS2). Using Lemma 5.8.1, each 1-cell maps either to a 0-simplex or a 1-simplex of the Diagram, and exactly as before the boundary circle of  $K$  maps to the Diagram in an essential way. The contradiction will be achieved once we show that the map extends over the 2-cells.

There is no change from before when the 2-cell meets  $\partial K$  or lies in the interior of  $K$  but does not contain a vertex of  $\Gamma$ , so we fix a

2-cell in the interior of  $K$  that is dual to a vertex  $v_0$  of  $\Gamma$ , located at a point  $(s_0, t_0)$ .

Suppose first that  $Q_{s_0} \cap P_{t_0}$  contains a spine of  $P_{t_0}$ . By Lemma 5.9.2, either  $V_{t_0}$  or  $W_{t_0}$  has a core circle  $C$  which is disjoint from  $Q_{s_0}$ ; we assume it lies in  $V_{t_0}$ , with the case when it lies in  $W_{t_0}$  being similar. The letter  $A$  cannot appear in the label of any region whose closure contains  $v_0$ , since  $C$  is a core circle for all  $P_t$  with  $t$  near  $t_0$ , and  $Q_s$  is disjoint from  $C$  for all  $s$  near  $s_0$ . By Lemma 5.6.2, any letter  $a$  that appears in the label of one of the regions whose closure contains  $v_0$  must appear in a combination of either  $ax$  or  $ay$ , so none of these regions has label  $A$ . Since each 1-cell maps to a 0- or 1-simplex of the Diagram, the map defined on the 1-cells of  $K$  maps the boundary of the 2-cell dual to  $v_0$  into the complement of the vertex  $A$  of the Diagram. Since this complement is contractible, the map can be extended over the 2-cell.

Suppose now that  $Q_{s_0} \cap P_{t_0}$  does not contain a spine of  $P_{t_0}$ . Then there is a loop  $C_{(s_0, t_0)}$  essential in  $P_{t_0}$  and disjoint from  $Q_{s_0}$ . For every  $(s, t)$  near  $(s_0, t_0)$ , there is a loop  $C_{(s, t)}$  essential in  $P_t$  and disjoint from  $Q_s$ , with the property that  $C_{(s, t)}$  is a meridian of  $V_t$  (respectively  $W_t$ ) if and only if  $C_{(s_0, t_0)}$  is a meridian of  $V_{t_0}$  (respectively  $W_{t_0}$ ). In particular, any intersection circle of  $Q_s$  and  $P_t$  which bounds a disk in  $Q_s$  which is precompressing for  $P_t$  in  $V_t$  or in  $W_t$  must be disjoint from  $C_{(s, t)}$ . Since the meridian disks of  $V_t$  and  $W_t$  have nonzero algebraic intersection, the meridians for  $V_t$  and  $W_t$  cannot both be disjoint from  $C_{(s, t)}$ . So for all  $(s, t)$  in this neighborhood of  $(s_0, t_0)$ , either all disks in  $Q_s$  that are precompressions for  $P_t$  are precompressions in  $V_t$ , or all are precompressions in  $W_t$ . In the first case, the letter  $B$  does not appear in the label of any of the regions whose closure contain  $v_0$ , while in the second case, the letter  $A$  does not. In either case, the extension to the 2-cell can now be obtained just as in the previous paragraph. This completes the proof of Theorem 5.9.1.

### 5.10. From good to very good

By virtue of Theorem 5.9.1, we may perturb a parameterized family of diffeomorphisms of  $M$  so that at each parameter  $u$ , some level  $P_t$  and some image level  $f_u(P_s)$  meet in good position. In this section, we use the methodology of A. Hatcher [22, 23] (see [25] for a more detailed version of [23], see also N. Ivanov [33]) to change the family so that we may assume that  $P_t$  and  $f_u(P_s)$  meet in very good position. In fact, we will achieve a rather stronger condition on discal intersections.

Following our usual notation, we fix a sweepout  $\tau: P \times [0, 1] \rightarrow M$  of a closed orientable 3-manifold  $M$ , and give  $P_t$ ,  $V_t$ , and  $W_t$  their usual

meanings. Given a parameterized family of diffeomorphisms  $f: M \times W \rightarrow M$ , we give  $f_u$ ,  $Q_s$ ,  $X_s$ , and  $Y_s$  their usual parameter-dependent meanings. From now on, we refer to the  $P_t$  as *levels* and the  $Q_s$  as *image levels*.

Throughout this section, we assume that for each  $u \in W$ , there is a pair  $(s, t)$  such that  $Q_s$  and  $P_t$  are in good position. Before stating the main result, we will need to make some preliminary selections.

By transversality, being in good position is an open condition, so there exist a finite covering of  $W$  by open sets  $U_i$ ,  $1 \leq i \leq n$ , and pairs  $(s_i, t_i)$ , so that for each  $u \in U_i$ ,  $Q_{s_i}$  and  $P_{t_i}$  meet in good position. By shrinking of the open cover, we can and always will assume that all transversality and good-position conditions that hold at parameters in  $U_i$  actually hold on  $\overline{U_i}$ .

We want to select the sets and parameters so that at parameters in  $U_i$ ,  $Q_{s_i}$  is transverse to  $P_{t_j}$  for all  $t_j$ . First note that for any  $s$  sufficiently close to  $s_i$ ,  $Q_s$  is transverse to  $P_{t_i}$  at all parameters of  $U_i$  (here we are already using our condition that the transversality for the  $Q_{s_i}$  holds for all parameters in  $\overline{U_i}$ ). On  $U_1$ ,  $Q_{s_1}$  is already transverse to  $P_{t_1}$ . Sard's Theorem ensures that at each  $u \in U_2$ , there is a value  $s$  arbitrarily close to  $s_2$  such that  $Q_s$  is transverse to  $P_{t_1}$  at all parameters in a neighborhood of  $u$ . Replace  $U_2$  by finitely many open sets (with associated  $s$ -values), for which on each of these sets the associated  $Q_s$  are transverse to  $P_{t_1}$ . The new  $s$  are selected close enough to  $s_2$  so that these  $Q_s$  still meet  $P_{t_2}$  in good position. Repeat this process for  $U_3$ , that is, replace  $U_3$  by a collection of sets and associated values of  $s$  for which the associated  $Q_s$  are transverse to  $P_{t_1}$  and still meet  $P_{t_3}$  in good position. Proceeding through the remaining original  $U_i$ , we have a new collection, with many more sets  $U_i$ , but only the same  $t_i$  values that we started with, and at each parameter in one of the new  $U_i$ ,  $Q_{s_i}$  is transverse to  $P_{t_1}$  as well as to  $P_{t_i}$ . Now proceed to  $P_{t_2}$ . For the  $U_i$  whose associated  $t$ -value is not  $t_2$ , we perform a similar process, and we also select the new  $s$ -values so close to  $s_i$  that the new  $Q_s$  are still transverse to  $P_{t_1}$  and still meet their associated  $P_{t_i}$  in good position. After finitely many repetitions, all  $Q_{s_i}$  are transverse to each  $P_{t_j}$ .

We may also assume the  $U_i$  are connected, by making each connected component a  $U_i$ . Since transversality is an open condition, we are free to replace  $s_i$  by a very nearby value, while still retaining the good position of  $Q_{s_i}$  and  $P_{t_i}$  and the transverse intersection of  $Q_{s_i}$  with all  $P_{t_j}$ , for all parameters in  $U_i$ , and similarly we may reselect any  $t_j$ . So (with the argument in the previous paragraph now completed) we can and always will assume that all  $s_i$  are distinct, and all  $t_i$  are distinct.

We can now state the main result of this section. With notation as above:

**THEOREM 5.10.1.** *Let  $f: W \rightarrow \text{diff}(M)$  be a parameterized family, such that for each  $u$  there exists  $(s, t)$  such that  $Q_s$  and  $P_t$  meet in good position. Then  $f$  may be changed by homotopy so that there exists a covering  $\{U_i\}$  as above, with the property that for all  $u \in U_i$ ,  $Q_{s_i}$  and  $P_{t_i}$  meet in very good position, and  $Q_{s_i}$  has no discal intersection with any  $P_{t_j}$ . If these conditions already hold for all parameters in some closed subset  $W_0$  of  $W$ , then the deformation of  $f$  may be taken to be constant on some neighborhood of  $W_0$ .*

Before starting the proof, we introduce a simplifying convention. Although strictly speaking,  $Q_{s_i}$  is meaningful at every parameter, as is every  $Q_s$ , throughout the remainder of this section we speak of  $Q_{s_i}$  only for parameters in  $\overline{U_i}$ . That is, unless explicitly stated otherwise, an assertion made about  $Q_{s_i}$  means that the assertion holds at parameters in  $\overline{U_i}$ , but not necessarily at other parameters. Also, to refer to  $Q_{s_i}$  at a single parameter  $u$ , we use the notation  $Q_{s_i}(u)$ . By our convention,  $Q_{s_i}(u)$  is meaningful only when  $u$  is a value in  $\overline{U_i}$ .

Now, to preview some of the complications that appear in the proof of Theorem 5.10.1, consider the problem of removing, just for a single parameter  $u \in U_i$ , a discal component  $c$  of the intersection of  $Q_{s_i}(u)$  with some  $P_{t_j}$ . Suppose that the disk  $D'$  in  $Q_{s_i}(u)$  bounded by  $c$  is innermost among all disks in  $Q_{s_i}(u)$  bounded by discal intersections of  $Q_{s_i}(u)$  with the  $P_{t_k}$ . Note that  $D'$  can contain a nondiscal intersection of  $Q_{s_i}(u)$  with a  $P_{t_k}$ ; such an intersection will be a meridian of either  $V_{t_k}$  or  $W_{t_k}$  (although  $k$  cannot equal  $i$ , since  $Q_{s_i}(u)$  and  $P_{t_i}$  meet in good position). Let  $D$  be the disk in  $P_{t_j}$  bounded by  $c$ , so that  $D \cup D'$  is the boundary of a 3-ball  $E$ . There is an isotopy of  $f_u$  that moves  $D'$  across  $E$  to  $D$ , and on across  $D$ , eliminating  $c$  and possibly other intersections of the  $Q_{s_\ell}(u)$  with the  $P_{t_k}$ . We will refer to this as a *basic isotopy*.

It is possible for a basic isotopy to remove a biessential component of some  $Q_{s_k}(u) \cap P_{t_k}$ . Examples are a bit complicated to describe, but involve ideas similar to the construction in Figure 5.2. Fortunately, the following lemma ensures that good position is not lost.

**LEMMA 5.10.2.** *After a basic isotopy as described above, each  $Q_{s_k}(u) \cap P_{t_k}$  still has a biessential component.*

**PROOF.** Throughout the proof of the lemma,  $Q_s$  is understood to mean  $Q_s(u)$ .



Suppose that a biessential component of some  $Q_{s_k} \cap P_{t_k}$  is contained in the ball  $E$ , and hence is removed by the isotopy. Since a spine of  $Q_{s_k}$  cannot be contained in a 3-ball, there must be a circle of intersection of  $Q_{s_k}$  with  $D$  that is essential in  $Q_{s_k}$ . This implies that  $k \neq j$ . Now  $D'$  must have nonempty intersection with  $P_{t_k}$ , since otherwise  $P_{t_k}$  would be contained in  $E$ . An intersection circle innermost on  $D'$  cannot be inessential in  $P_{t_k}$ , since  $c$  was an innermost discal intersection on  $Q_{s_i}$ , so  $D'$  contains a meridian disk  $D'_0$  for either  $V_{t_k}$  or  $W_{t_k}$ . Choose notation so that  $D$  is contained in  $V_{t_k}$  (that is,  $t_j < t_k$ ).

Suppose first that  $D'_0 \subset V_{t_k}$ . The basic isotopy pushing  $D'$  across  $E$  moves  $Q_{s_k} \cap E$  into a small neighborhood of  $D$ , so that it is contained in  $V_{t_k}$ . If there is no longer any biessential intersection of  $Q_{s_k}$  with  $P_{t_k}$ , then the complement in  $V_{t_k}$  of the original  $D'_0$  contains a spine of  $Q_{s_k}$  (since the original intersection of  $Q_{s_k}$  with  $D$  contained a loop essential in  $Q_{s_k}$ , the spine of  $Q_{s_k}$  is now on the  $V_{t_k}$ -side of  $P_{t_k}$ ). This is a contradiction, since  $Q_{s_k}$  is a Heegaard torus.

Suppose now that  $D'_0 \subset W_{t_k}$ . Since the biessential circles of  $Q_{s_k} \cap P_{t_k}$  are disjoint from  $D'_0$ , they are meridians for  $W_{t_k}$  and hence are essential in  $V_{t_k}$ . Now, let  $A$  be innermost among the annuli on  $Q_{s_k}$  bounded by a biessential component  $C$  of  $Q_{s_k} \cap P_{t_k}$  and a circle of  $Q_{s_k} \cap D$ . Since  $Q_{t_k}$  and  $P_{t_k}$  meet in good position, the intersection of the interior of  $A$  with  $P_{t_k}$  is discal. This implies that  $C$  is contractible in  $V_{t_k}$ , a contradiction.  $\square$

**PROOF OF THEOREM 5.10.1.** We will adapt the approach used by Hatcher [22]. The principal difference for us is that in [22], there is only a single domain level, whereas we have the different  $Q_{s_i}$  on the sets  $U_i$ .

The first step is to construct a family  $h_{u,t}$ ,  $0 \leq t \leq 1$  of isotopies of the  $f_u = h_{u,0}$ , which eliminates the discal intersections of every  $Q_{s_i}(u)$  with every  $P_{t_j}$ . Let  $\mathcal{C}$  be the set of discal intersection curves of all  $Q_{s_i} \cap P_{t_j}$  for all  $u$ , where as previously explained, this refers only to the  $Q_{s_i}(u)$  with  $u \in U_i$ . Since  $Q_{s_i}$  is transverse to  $P_{t_j}$  at all  $u \in \overline{U}_i$ , the curves in  $\mathcal{C}$  fall into finitely many families which vary by isotopy as the parameter  $u$  moves over (the connected set)  $\overline{U}_i$ . Thus we may regard  $\mathcal{C}$  as a disjoint union containing finitely many copies of each  $\overline{U}_i$ . It projects to  $W$ , with the inverse image of  $u$  consisting of the discal intersection curves  $\mathcal{C}_u$  of the  $Q_{s_i}(u)$  and  $P_{t_j}$  for which  $u \in U_i$ . By assumption, no element of  $\mathcal{C}$  projects to any parameter  $u \in W_0$ .

Each  $c \in \mathcal{C}_u$  bounds unique disks  $D_c \subset P_{t_j}$  and  $D'_c \subset Q_{s_i}(u)$  for some  $i$  and  $j$ . The inclusion relations among the  $D_c$  define a partial ordering  $<_P$  on  $\mathcal{C}_u$ , by the rule that  $c_1 <_P c_2$  when  $D_{c_1} \subset D_{c_2}$ . Similarly,  $c_1 <_Q c_2$  when  $D'_{c_1} \subset D'_{c_2}$ .

If  $c$  is minimal for  $<_Q$ , then  $D'_c \cup D_c$  is an embedded 2-sphere in  $M$  which bounds a 3-ball  $E_c$ . By Lemma 5.10.2, the basic isotopy that pushes  $D'_c$  across  $E_c$  to  $D_c$  and on to the other side of  $D_c$  retains the property that every  $Q_{s_k}(u) \cap P_{s_k}$  has a biessential intersection. This ensures that when all discal intersections have been eliminated, each  $Q_{s_k}(u) \cap P_{t_k}$  will still intersect, so they will be in very good position.

Shrink the open cover  $\{U_i\}$  to an open cover  $\{U'_i\}$  for which each  $\overline{U'_i} \subset U_i$ . To construct the  $h_{u,t}$ , Hatcher introduced an auxiliary function  $\Psi: \mathcal{C} \rightarrow (0, 2)$  that gives the order in which the elements of  $\mathcal{C}$  are to be eliminated, and allows the basic isotopies to be tapered off as one nears the frontier of  $U_i$ . Denoting by  $\psi_u$  the restriction of  $\Psi$  to  $\mathcal{C}_u$ , we will select  $\Psi$  so that the following conditions are satisfied:

- (1)  $\psi_u(c) < \psi_u(c')$  whenever  $c <_Q c'$
- (2)  $\psi_u(c) < 1$  if  $c \subset Q_{s_i}(u)$  and  $u \in \overline{U'_i}$
- (3)  $\psi_u(c) > 1$  if  $c \subset Q_{s_i}(u)$  and  $u \in \overline{U'_i} - U_i$ .

One way to construct such a  $\Psi$  is to choose a Riemannian metric on  $\tau(P \times (0, 1))$  for which each  $P_t$  has area 1, and define  $\Psi_0(c)$  to be the area of  $f_u^{-1}(D'_c)$  in  $P_{s_i}$ . Then, choose continuous functions  $\alpha_i$  which are 0 on  $\overline{U'_i}$  and 1 on  $W - U_i$ , and define  $\Psi(c) = \Psi_0(c) + \alpha_i(u)$  for  $c \subset Q_{s_i}(u)$ .

Roughly speaking, the idea of Hatcher's construction is to have  $h_{u,t}$  perform the basic isotopy that eliminates  $c$  during a small time interval  $I_u(c)$  which starts at the number  $\psi_u(c)$ . In order to retain control of this process, preliminary steps must be taken to ensure that basic isotopies that move points in intersecting 3-balls  $E_c$  do not occur at the same time.

If  $c$  is a discal intersection of  $U_{s_i}$  and  $P_{t_j}$ , we denote  $U_i$  and  $U'_i$  by  $U(c)$  and  $U'(c)$ . For a fixed isotopic family of  $c \in \mathcal{C}$  with  $c \subset Q_{s_i}$ , the points  $(u, \psi_u(c))$  form a  $d$ -dimensional sheet  $i(c)$  lying over  $U(c)$ , where  $d$  is the dimension of  $W$ . If  $i(c_1)$  meets  $i(c_2)$ , then by the first property of  $\Psi$ ,  $c_1$  and  $c_2$  cannot be  $<_Q$ -related.

Thicken each  $i(c)$  to a plate  $I(c)$  intersecting each  $\{u\} \times [0, 2]$  in an interval  $I_u(c) = [\psi_u(c), \psi_u(c) + \epsilon]$ , for some small positive  $\epsilon$ . This interval will contain the  $t$ -support of the portion of  $h_{u,t}$  that eliminates  $c$ , assuming that all other loops in  $\mathcal{C}_u$  with smaller  $\psi_u$ -value have already been eliminated. By condition (1),  $c$  will be  $<_Q$ -minimal at the times  $t \in I_u(c)$ . Since  $\mathcal{C}_u$  is empty for  $u \in W_0$ , the  $h_{u,t}$  will be constant for all  $u \in W_0$ .

Choose the  $\epsilon$  small enough so that  $I(c_1) \cap I(c_2)$  is nonempty only near the intersections of  $i(c_1)$  and  $i(c_2)$ . This ensures that if basic isotopies eliminating  $c_1$  and  $c_2$  occur on overlapping time intervals,

then  $c_1$  and  $c_2$  are  $<_Q$ -unrelated. Also, choose  $\epsilon$  small enough so that  $I_u(c) \subset [0, 1]$  whenever  $u \in U'_i$ .

Write  $G_0$  for the union of the  $i(c)$ , and  $G$  for the union of the  $I(c)$ .

It may happen that for some  $c_1, c_2 \in \mathcal{C}_u$  with  $\psi_u(c_1) < \psi_u(c_2)$ , we have  $c_2 <_P c_1$ . In this case the isotopy which eliminates  $c_1$  will also eliminate  $c_2$ . So reduce  $G$  by deleting all points  $(u, \psi_u(c_2))$  such that  $\psi_u(c_1) < \psi_u(c_2)$  for some  $c_1$  with  $c_2 <_P c_1$ . Make a corresponding reduction of  $I(c_2)$  by deleting points  $t \in I_u(c_2)$  such that  $t > \psi_u(c_1)$  for some  $c_1$  with  $c_2 <_P c_1$ .

There is a subtle danger here. Suppose that in the previous paragraph,  $u \in U(c_1) - \overline{U'(c_1)}$ . If part of  $I_u(c_1)$  extends into  $(1, 2]$ , then the isotopy eliminating  $c_1$  may not be completed, and therefore  $c_2$  would not be eliminated. If  $u \in \overline{U(c_2)} - U'(c_2)$  this does not matter, since we only need to complete the elimination of  $c_2$  at parameters in  $U'(c_2)$ . But the plate thickness  $\epsilon$  must be selected small enough so that  $I_u(c_2)$  lies in  $[0, 1]$  at all  $u$  for which there is a  $c_2$  with  $u \in \overline{U'(c_2)}$  and  $\psi_u(c_2) > \psi_u(c_1)$ . This is possible because the set of such  $u$  is a compact subset of  $U_i$ .

At values of  $t$  where the interiors of  $I(c_1)$  and  $I(c_2)$  still overlap,  $c_1$  and  $c_2$  are  $<_Q$ -unrelated, and the reduction just made ensures that they are  $<_P$ -unrelated. In Hatcher's context, all intersections are discal, so the combined effect of these is to eliminate the possibility of simultaneous isotopies on intersecting 3-balls  $E_{c_1}$  and  $E_{c_2}$ . In our context, however,  $E_{c_1}$  and  $E_{c_2}$  can intersect on overlaps of  $I(c_1)$  and  $I(c_2)$  even when  $c_1$  and  $c_2$  are neither  $<_P$ -related nor  $<_Q$ -related. Figure 5.12 shows a simple example. The intersections of  $P_{t_1}$  with  $Q_{s_2}$ , are not discal, nor are the intersections of  $P_{t_2}$  with  $Q_{s_1}$ , but  $Q_{s_2}$  has a discal intersection with  $P_{t_2}$  inside  $E(c_1)$ . When this happens, however,  $E_{c_1}$  and  $E_{c_2}$  must be either disjoint or nested:

**LEMMA 5.10.3.** *Suppose that  $c_1$  and  $c_2$  are  $<_Q$ -minimal discal intersections, and are neither  $<_P$ -related nor  $<_Q$ -related. Then  $\partial E_{c_1}$  and  $\partial E_{c_2}$  are disjoint.*

**PROOF.** Since  $c_1$  and  $c_2$  are not  $<_Q$ -related,  $D'(c_1)$  and  $D'(c_2)$  are disjoint, and since they are not  $<_P$ -related,  $D(c_1)$  and  $D(c_2)$  are disjoint. An intersection circle of  $D(c_1)$  and  $D'(c_2)$  would be smaller than  $c_2$  in the  $<_Q$ -ordering, and similarly an intersection circle of  $D'(c_1)$  and  $D(c_2)$  would be smaller than  $c_1$  in the  $<_Q$ -ordering.  $\square$

When  $E_{c_1}$  and  $E_{c_2}$  are nested, say,  $E_{c_2}$  lies in  $E_{c_1}$ , a basic isotopy that removes  $c_1$  will also remove  $c_2$ . So we make the further reduction in  $G_0$  of deleting all  $(u, \psi_u(c_2))$  for which there is a  $c_1$  such that  $i(c_1)$  meets  $i(c_2)$ ,  $\psi_u(c_1) < \psi_u(c_2)$ , and  $E_{c_2} \subset E_{c_1}$ . Also, reduce  $I(c_2)$  by

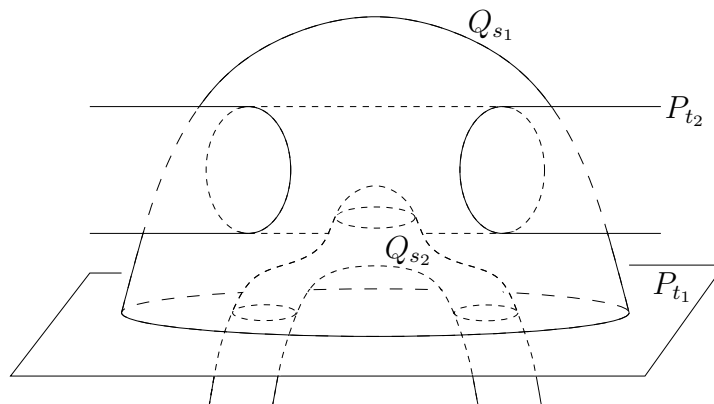

FIGURE 5.12. Nested ball regions for basic isotopies.

removing any  $t$  in  $I_u(c_2)$  with  $t > \psi_u(c_1)$ . Again, this may require the plate thickness to be decreased to ensure that  $I_u(c_1)$  lies in  $[0, 1]$  at parameters in  $U(c_1)$  where  $u \in \overline{U'(c_2)}$

For fixed  $u \in W$ , the basic isotopies are combined by proceeding upward in  $W \times [0, 2]$  from  $t = 0$  to  $t = 1$ , performing each basic isotopy involving  $c$  on the interval  $I_u(c)$ . Condition (3) on the  $\psi_u$  ensures that the basic isotopies involving  $c \subset Q_{s_i}(u)$  taper off at parameters near the frontier of  $U_i$ . On a reduced interval  $I_u(c)$ , which is an initial segment of  $[\psi_u(c), \psi_u(c) + \epsilon]$ , perform only the corresponding initial portion of the basic isotopy. On the overlaps of the  $I(c)$ , perform the corresponding basic isotopies concurrently; the reductions of the  $I(c)$  have ensured that these basic isotopies will have disjoint supports. Since  $\epsilon$  was chosen small enough so that  $I_u(c) \subset [0, 1]$  whenever  $u \in U'_i$ , the basic isotopies involving  $Q_{s_i}$  will be completed at all  $u$  in  $U'_i$ . Since  $\mathcal{C}_u$  is empty for  $u \in W_0$ , no isotopies take place at parameters in  $W_0$ .

The remaining concern is that the basic isotopies eliminating  $c \subset Q_{s_i}(u)$  must be selected so that they fit together continuously in the parameter  $u$  on  $U_i$ . This can be achieved using the method in the last paragraph on p. 345 of [22] (which applies in the smooth category by virtue of [24], see also the more detailed version in [25]).  $\square$

### 5.11. Setting up the last step

In this section, we present some technical lemmas that will be needed for the final stage of the proof.

The first two lemmas give certain uniqueness properties for the fiber of the Hopf fibration on  $L$ . Both are false for  $\mathbb{R}P^3$ , so require our convention that  $L = L(m, q)$  with  $m > 2$ , and as usual we select

$q$  so that  $1 \leq q < m/2$ . From now on, we endow  $L$  with the Hopf fibering and assume that our sweepout of  $L$  is selected so that each  $P_t$  is a union of fibers. Consequently the exceptional fibers, if any, will be components of the singular set  $S$ .

LEMMA 5.11.1. *Let  $P$  be a Heegaard torus in  $L$  which is a union of fibers, bounding solid tori  $V$  and  $W$ . Suppose that a loop in  $P$  is a longitude for  $V$  and for  $W$ . Then  $q = 1$  and the loop is isotopic in  $P$  to a fiber.*

PROOF. Let  $a$  and  $b$  be loops in  $P$  which are respectively a longitude and a meridian of  $V$ , and with  $a$  determined by the condition that  $ma + qb$  is a meridian of  $W$ . Let  $c$  be a loop in  $P$  which is a longitude for both  $V$  and  $W$ . Since  $c$  is a longitude of  $V$ , it has (for one of its two orientations) the form  $a + kb$  in  $H_1(P)$  for some  $k$ . The intersection number of  $c$  with  $ma + qb$  is  $q - km$ , which must be  $\pm 1$  since  $c$  is a longitude of  $W$ . Since  $1 \leq q < m/2$  and  $m > 2$ , this implies that  $k = 0$  and  $q = 1$ . Since  $k = 0$ ,  $c$  is uniquely determined and  $c = a$ . Since  $q = 1$ , the Hopf fibering is nonsingular, so the fiber is a longitude of both  $V$  and  $W$  and hence is isotopic in  $P$  to  $c$ .  $\square$

LEMMA 5.11.2. *Let  $h: L \rightarrow L$  be a diffeomorphism isotopic to the identity, with  $h(P_s) = P_t$ . Then the image of a fiber of  $P_s$  is isotopic in  $P_t$  to a fiber.*

PROOF. Composing  $f$  with a fiber-preserving diffeomorphism of  $L$  that moves  $P_s$  to  $P_t$ , we may assume that  $s = t$ . Write  $P$ ,  $V$ , and  $W$  for  $P_t$ ,  $V_t$ , and  $W_t$ . Let  $a$  and  $b$  be loops in  $P$  selected as in the proof of Lemma 5.11.1, and write  $h_*: H_1(P) \rightarrow H_1(P)$  for the induced isomorphism.

Suppose first that  $h(V) = V$ . Since the meridian disk of  $V$  is unique up to isotopy, we have  $h_*(b) = \pm b$ . Since  $h$  is isotopic to the identity on  $L$  and  $m > 2$ ,  $h$  is orientation-preserving and induces the identity on  $\pi_1(V)$ . This implies that  $h_*(b) = b$ . Similar considerations for  $W$  show that  $h_*(ma + qb) = ma + qb$ , so  $h_*(a) = a$ . Thus  $h_*$  is the identity on  $H_1(P)$  and the lemma follows for this case.

Suppose now that  $h(V) = W$ . Then  $h$  is orientation-reversing on  $P$ . Since  $h$  must take a meridian of  $V$  to one of  $W$ , we have  $h_*(b) = \epsilon(ma + qb)$  where  $\epsilon = \pm 1$ . Writing  $h_*(a) = ua + vb$ , we find that  $1 = a \cdot b = -h_*(a) \cdot h_*(b) = -\epsilon(qu - mv)$ . The facts that  $h$  is isotopic to the identity on  $L$ ,  $a$  generates  $\pi_1(L)$ , and  $b$  is 0 in  $\pi_1(V)$  imply that  $u \equiv 1 \pmod{m}$ , so modulo  $m$  we have  $1 \equiv -\epsilon q$ . Since  $1 \leq q < m/2$ , this forces  $q = 1$ ,  $\epsilon = -1$ , and  $h_*(b) = -ma - b$ . Since  $a$  has intersection number  $-1$  with the meridian  $-ma - b$  of  $W$ , it is also a longitude of

$W$ . Since  $h$  is a homeomorphism interchanging  $V$  and  $W$ ,  $h(a)$  is also a longitude of  $V$  and of  $W$ , and an application of Lemma 5.11.1 completes the proof.  $\square$

We now give several lemmas which allow the deformation of diffeomorphisms and embeddings to make them fiber-preserving or level-preserving. The first is just a special case of Theorem 3.9.1:

**LEMMA 5.11.3.** *Let  $X$  be either a solid torus or  $S^1 \times S^1 \times I$ , with a fixed Seifert fibering. Then the inclusion  $\text{diff}_f(X) \rightarrow \text{diff}(X)$  is a homotopy equivalence.*

Lemma 5.11.3 guarantees that if  $g: \Delta \rightarrow \text{diff}(X)$  is a continuous map from an  $n$ -simplex,  $n \geq 1$ , with  $g(\partial\Delta) \subset \text{diff}_f(X)$ , then  $g$  is homotopic relative to  $\partial\Delta$  to a map with image in  $\text{diff}_f(X)$ .

The next lemma is a 2-dimensional version of Theorem 3.9.1, and can be proven using surface theory. In fact, it can be proven by applying Theorem 3.9.1 to  $T \times I$ , although that would be a strange way to approach it.

**LEMMA 5.11.4.** *Let  $T$  be a torus with a fixed  $S^1$ -fibering. Let  $\text{Diff}_h(T)$  be the subgroup of  $\text{Diff}(T)$  consisting of the diffeomorphisms that take some fiber to a loop isotopic to a fiber. Then the inclusion  $\text{Diff}_f(T) \rightarrow \text{Diff}_h(T)$  is a homotopy equivalence.*

For  $e \in (0, 1)$  we let  $eD^2$  denote the concentric disk of radius  $e$  in the standard disk  $D^2 \subset \mathbb{R}^2$ . Let  $X$  be either a solid torus  $D^2 \times S^1$ , or  $T \times I$  where  $T$  is a torus. Let  $F = \cup F_i$  be a disjoint union of finitely many tori. Fix an inclusion of  $F$  into  $X$  such that each  $F_i$  is of the form  $\partial(e_i D^2 \times S^1)$ , in the solid torus case, or of the form  $T \times \{e_i\}$ , in the  $T^2 \times I$  case, for distinct numbers  $e_i$  in  $(0, 1)$ . Let  $\text{emb}_{\text{int}}(F, X)$  be the connected component of the inclusion in the space of all embeddings of  $F$  into the interior of  $X$ , and let  $\text{emb}_{\text{conc}}(F, X)$  be the connected component of the inclusion in the set of embeddings for which each  $F_i$  is of the form  $\partial(eD^2) \times S^1$  or  $T \times \{e\}$  for some  $e \in (0, 1)$ . We omit the proof of the next lemma, which is analogous to Lemma 4.8.1.

**LEMMA 5.11.5.** *Let  $X$  be a Seifert-fibered solid torus or  $S^1 \times S^1 \times I$ . Then the inclusion  $\text{emb}_{\text{conc}}(F, X) \rightarrow \text{emb}_{\text{int}}(F, X)$  is a homotopy equivalence.*

## 5.12. Deforming to fiber-preserving families

**THEOREM 5.12.1.** *Let  $L = L(m, q)$  with  $m > 2$  and let  $f: S^d \rightarrow \text{diff}(L)$ . Then  $f$  is homotopic to a map into  $\text{diff}_f(L)$ .*

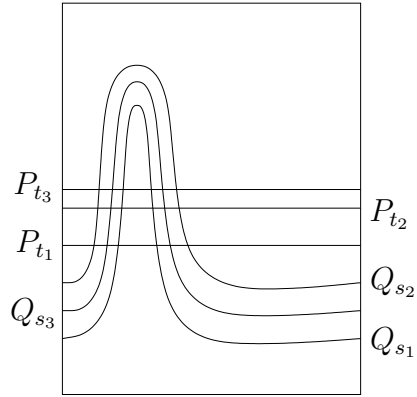

FIGURE 5.13. A block of level tori with the  $Q_{s_i}$  out of order.

PROOF. Applying Theorems 5.8.2, 5.9.1, and 5.10.1, we may assume that  $f$  satisfies the conclusion of Theorem 5.10.1. That is, there are pairs  $(s_i, t_i)$  and an open cover  $\{U_i\}$  of  $S^d$  with the property that for every  $u \in U_i$ ,  $Q_{s_i}(u)$  and  $P_{t_i}$  meet in very good position, and  $Q_{s_i}(u)$  meets every  $P_{t_j}$  transversely, with no discal intersections. The  $U_i$  are selected to be connected, so the intersection  $Q_{s_i}(u) \cap P_{t_j}$  is independent, up to isotopy in  $P_{t_j}$ , of the parameter  $u$ . We remind the reader of our convention that assertions about  $Q_{s_i}$  implicitly mean “for every  $u \in U_i$ .” We can and always will assume that conditions stated for parameters in  $U_i$  actually hold for all parameters in  $\overline{U_i}$ .

Since the  $t_j$  are distinct, we may select notation so that  $t_1 < t_2 < \dots < t_m$ . The corresponding  $s_i$  typically are not in ascending order. Figure 5.13 shows a schematic picture of a block of three levels for which the image levels  $Q_{s_1}$ ,  $Q_{s_2}$ , and  $Q_{s_3}$  have  $s_1 < s_3 < s_2$ .

The basic idea of the proof is to make the  $f_u$  fiber-preserving on the  $P_{s_i}$ , then use Lemma 5.11.3 to make the  $f_u$  fiber-preserving on the complementary  $S^1 \times S^1 \times I$  or solid tori of the  $P_{s_i}$ -levels. We must be very careful that none of the isotopic adjustments to a  $Q_{s_i}$  destroys any condition that must be preserved on the other  $Q_{s_j}$ .

Before listing the steps in the proof of Theorem 5.12.1, a definition is needed. For each  $i$ , the intersection circles of  $Q_{s_i} \cap P_{t_i}$  cannot be meridians in both  $V_{t_i}$  and  $W_{t_i}$ , so  $Q_{s_i}$  must satisfy exactly one of the following:

- (1) The circles of  $Q_{s_i} \cap P_{t_i}$  are not longitudes or meridians for  $V_{t_i}$ , so the annuli of  $Q_{s_i} \cap V_{t_i}$  are uniquely boundary parallel in  $V_{t_i}$ .
- (2) The circles of  $Q_{s_i} \cap P_{t_i}$  are longitudes or meridians for  $V_{t_i}$ , but are not longitudes or meridians for  $W_{t_i}$ , so the annuli of  $Q_{s_i} \cap W_{t_i}$  are uniquely boundary parallel in  $W_{t_i}$ .
- (3) The circles of  $Q_{s_i} \cap P_{t_i}$  are longitudes both for  $V_{t_i}$  and for  $W_{t_i}$ .

In the first case, we say that  $Q_{s_i}$  and  $P_{t_i}$  are  $V$ -cored, in the second that they are  $W$ -cored, and in the third that they are *bilongitudinal*. If they are either  $V$ -cored or  $W$ -cored, we say they are *cored*. Lemma 5.11.1 shows that the bilongitudinal case can occur only when  $q = 1$ , and then only when the intersection circles are isotopic in  $P_{t_i}$  to fibers of the Hopf fibering.

We can now list the steps in the procedure. In this list, and in the ensuing details, “push  $Q_{s_i}$ ” means perform a deformation of  $f$  that moves  $Q_{s_i}$  as stated, and preserves all other conditions needed. Making  $Q_{s_i}$  “vertical” (at a parameter  $u$ ) means making the restriction of  $f_u$  to  $P_{s_i}$  fiber-preserving. When we say that something is done “at all parameters of  $U_i$ ,” we mean that a deformation of  $f$  will be performed, and that  $U_i$  is replaced by a smaller set, so that the result is achieved for all parameters in the new  $\overline{U_i}$ , while retaining all other needed properties (such as that  $\{U_i\}$  is an open covering of  $S^d$ ).

1. Push the  $Q_{s_i}$  that meet  $P_{t_j}$  out of  $V_{t_j}$ , for all the  $V$ -cored  $P_{t_j}$ , at all parameters in  $U(t_j)$ . At the end of this step, each  $Q_{s_i}$  that was  $V$ -cored is parallel to  $P_{t_i}$ .
2. Push the  $Q_{s_i}$  that meet  $P_{t_j}$  out of  $W_{t_j}$ , for all the  $W$ -cored  $P_{t_j}$ , at all parameters in  $U(t_j)$ . At the end of this step, each  $Q_{s_i}$  that was  $W$ -cored is parallel to  $P_{t_i}$ .

These first two steps are performed using a method of Hatcher like that of the proof of Section 5.10, although simpler. After they are completed, a triangulation of  $S^d$  is fixed with mesh smaller than a Lebesgue number for the open cover by the  $U_i$ . Each of the remaining steps is performed by inductive procedures that move up the skeleta of the triangulation, achieving the objective for  $Q_{s_i}$  at all parameters that lie in a simplex completely contained in  $U_i$ .

3. Push the  $Q_{s_i}$  that originally were cored so that each one equals some level torus. These level tori may vary from parameter to parameter.
4. Push the  $Q_{s_i}$  that originally were cored to be vertical.
5. Push the bilongitudinal  $Q_{s_i}$  to be vertical.
6. Use Lemma 5.11.3 to make  $f_u$  fiber-preserving on the complementary  $S^1 \times S^1 \times I$  or solid tori of the  $P_{s_i}$ -levels.

The underlying fact that allows all of this pushing to be carried out without undoing the results of the previous work is Lemma 5.5.1. Its use involves the concepts of *compatibility* and *blocks*, which we will now define.



Recall that  $R(t_i, t_j)$  means the closure of the region between  $P_{t_i}$  and  $P_{t_j}$ . For a connected subset  $Z$  of  $S^d$ , which in practice will be either a single parameter or a simplex of a triangulation, denote by  $B_Z$  the set of  $t_i$  such that  $Z \subset U_i$ . Elements  $t_i$  and  $t_j$  of  $B_Z$  are called  $Z$ -compatible when  $Q_{s_i}(u) \cap P_{t_i}$  and  $Q_{s_k}(u) \cap P_{t_k}$  are homotopic in  $R(t_i, t_k)$  for every  $t_k \in B_Z$  with  $t_i < t_k \leq t_j$ .

Because our family  $f$  satisfies the conclusion of Theorem 5.10.1, Lemma 5.5.1 has the following consequence: if  $t_i$  and  $t_j$  are  $u$ -compatible for any  $u$ , then  $P_{t_i}$  and  $P_{t_j}$  are both  $V$ -cored, or both  $W$ -cored, or both bilongitudinal. The next proposition is also immediate from Lemma 5.5.1.

**PROPOSITION 5.12.2.** *Suppose that  $t_i, t_j, t_k \in B_Z$ . Then at parameters in  $Z$ ,  $Q_{s_k}$  can meet both  $P_{t_i}$  and  $P_{t_j}$  only if  $t_i$  and  $t_j$  are  $Z$ -compatible.*

For a simplex  $\Delta$ , write  $B_\Delta = \{b_1, \dots, b_m\}$  with each  $b_i < b_{i+1}$ , and for each  $i \leq m$  define  $a_i$  to be the  $s_j$  for which  $b_i = t_j$ . Decompose  $B_\Delta$  into maximal  $\Delta$ -compatible blocks  $C_1 = \{b_1, b_2, \dots, b_{\ell_1}\}$ ,  $C_2 = \{b_{\ell_1+1}, \dots, b_{\ell_2}\}$ ,  $\dots$ ,  $C_r = \{b_{\ell_{r-1}+1}, \dots, b_{\ell_r}\}$ , with  $\ell_r = m$ . Since the blocks are maximal, Proposition 5.12.2 shows that  $Q_{a_i}$  is disjoint from  $P_{b_j}$  if  $b_i$  and  $b_j$  are not in the same block. In steps 3 through 6, this disjointness will ensure that isotopies of these  $Q_{a_i}$  do not disturb the results of previous work.

Note that if  $b_i$  and  $b_j$  lie in the same block, then either both  $P_{b_i}$  and  $P_{b_j}$  are  $V$ -cored, or both are  $W$ -cored, or both are bilongitudinal. Thus we can speak of  $V$ -cored blocks, and so on.

When  $\delta$  is a face of  $\Delta$ ,  $B_\Delta \subseteq B_\delta$ . Therefore if  $b_i$  and  $b_j$  in  $B_\Delta$  are  $\delta$ -compatible, then they are  $\Delta$ -compatible. So for each block  $C$  of  $B_\delta$ ,  $C \cap B_\Delta$  is contained in a block of  $B_\Delta$ . However, levels that are not compatible in  $B_\delta$  may become compatible in  $B_\Delta$ , since the  $t_i$  for intervening levels in  $B_\delta$  may fail to be in  $B_\Delta$ . Typically, the intersections of blocks of  $B_\delta$  with  $B_\Delta$  will combine into larger blocks in  $B_\Delta$ .

We should emphasize that during steps 1 through 6, the blocks of  $B_Z$ , and whether a level  $P_{t_i}$  is  $V$ -cored,  $W$ -cored, or bilongitudinal, are defined with respect to the original configuration, not the new positioning after the procedure begins. Indeed, after steps 1 and 2, many of the  $Q_{s_i}$  will be disjoint from their  $P_{t_i}$ .

We now fill in the details of these procedures.

*Step 1: Push the  $Q_{s_i}$  that meet  $P_{t_j}$  out of  $V_{t_j}$ , for all the  $V$ -cored  $P_{t_j}$ , at all parameters in  $U(t_j)$ .*

We perform this in order of increasing  $t_j$  for the  $V$ -cored image levels. Begin with  $t_1$ . If  $Q_{s_1}$  is  $W$ -cored or bilongitudinal, do nothing.

Suppose it is  $V$ -cored. Then for each  $u$  in  $U(t_1)$ , the  $Q_{s_j}(u)$  that meet  $P_{t_1}$  intersect  $V_{t_1}$  in a union of incompressible uniquely boundary-parallel annuli. Since any such  $Q_{s_j}$  are transverse to  $P_{t_1}$  at each point of  $U(t_j)$ , the set of intersection annuli  $Q_{s_j} \cap V_{t_1}$  falls into finitely many isotopic families, with each family a copy of the connected set  $U(t_j)$ . For each  $j$  with  $U(t_1) \cap U(t_j)$  nonempty, let  $\mathcal{A}_j$  be the collection of the annuli  $Q_{s_j} \cap V_{t_1}$ , over all parameters in  $U(t_j)$ , and let  $\mathcal{A}$  be the union of these  $\mathcal{A}_j$ . The nonempty intersection of  $U(t_1)$  and  $U(t_j)$  ensures that the loops of  $Q_{s_j} \cap P_{t_1}$  and  $Q_{s_1} \cap P_{t_1}$  are all in the same isotopy class in  $P_{t_1}$ .

One might hope to push these families of annuli out of  $V_{t_1}$  one at a time, beginning with an outermost one, but an outermost family might not exist. There could be a sequence  $U(t_{j_1}), \dots, U(t_{j_k})$  such that  $U(t_{j_i}) \cap U(t_{j_{i+1}})$  is nonempty for each  $i$ ,  $U(t_{j_k}) \cap U(t_{j_1})$  is nonempty, and for some parameters  $u_{j_i}$  in  $U(t_{j_i})$ , an annulus  $Q_{s_{j_{i+1}}}(u_{j_i}) \cap V_{t_1}$  lies outside one of  $Q_{s_{j_i}}(u_{j_i}) \cap V_{t_1}$  for each  $i$ , and an annulus of  $Q_{s_{j_1}}(u_{j_k}) \cap V_{t_1}$  lies outside one of  $Q_{s_{j_k}}(u_{j_k}) \cap V_{t_1}$ . Since an outermost family might not exist, we will need to utilize the method of Hatcher as in the proof of Theorem 5.10.1, but only a simple version of it.

Shrink the  $U_i$  slightly, obtaining a new open cover by sets  $U'_i$  with  $\overline{U'_i} \subset U_i$ . We will use a function  $\Psi: \mathcal{A} \rightarrow (0, 2)$ , so that at each parameter  $u$ , the restriction  $\psi_u$  of  $\Psi$  to the annuli at that parameter has the property that  $\psi_u(A_1) < \psi_u(A_2)$  whenever  $A_1, A_2 \in \mathcal{A}_i$  and  $A_1$  lies in the region of parallelism between  $A_2$  and  $\partial V_{t_1}$ . Moreover, we will have  $\psi_u(A) < 1$  whenever  $A \in \mathcal{A}_i$  and  $u \in \overline{U'_i}$ , while  $\psi_u(A) > 1$  for  $u$  near the boundary of  $U_i$ . We construct  $\Psi$  by letting  $\Psi_0(A)$  be the volume of the region of parallelism between  $A$  and an annulus in  $\partial V_{t_1}$  (assuming that the volume of  $L$  has been normalized to 1 to ensure that  $\Psi_0(A) < 1$ ), then adding on auxiliary values  $\alpha_i(u)$  as in the proof of Theorem 5.10.1.

Form the union  $G_0 \subset S^d \times (0, 2)$  of the  $(u, \psi_u(A))$  as in the proof of Theorem 5.10.1, and thicken each of its sheets as was done there, obtaining an interval for each parameter. These intervals tell the supports of the isotopies that push the annuli of  $Q_{s_j} \cap V_{t_1}$  out of  $V_{t_1}$ . If two sheets of  $\mathcal{A}$  cross in  $S^d \times (0, 2)$ , then the corresponding regions of parallelism have the same volume, so must be disjoint and the isotopies can be performed simultaneously without interference. At each individual parameter  $u$ , each annulus is outermost during the time it is being pushed out of  $V_{t_1}$ , but the times need to be different since there may be no outermost family.

After the process is completed,  $Q_{s_j}$  will lie outside of  $V_{t_1}$  at all parameters in  $\overline{U(t_j)'}'$ , whenever  $U(t_j)$  had nonempty intersection with  $U(t_1)$ . Replacing each  $U(t_j)$  by  $U(t_j)'$ , we have  $Q_{s_j}$  pushed out of  $V_{t_1}$  at all parameters in these  $U(t_j)$ . Moreover, Lemma 5.4.3(2) shows that  $V_{t_1}$  is concentric in either  $X_{s_1}$  or  $Y_{s_1}$  at all parameters in  $U(t_1)$ .

Some of the  $Q_{s_k}$  for which  $U(t_k)$  did not meet  $U(t_1)$  may be moved by the isotopies of the  $Q_{s_j}$  at parameters in  $U(t_j) \cap U(t_k)$ . The condition that these  $Q_{s_k}$  meet  $P_{t_1}$  transversely may be lost, but this will not matter, because these intersections never matter when  $U(t_k)$  does not meet  $U(t_1)$ .

Now consider  $t_2$ . Again, we do nothing if  $Q_{s_2}$  is  $W$ -cored or bilongitudinal, so suppose that it is  $V$ -cored. Use the Hatcher process as before, to push annuli in the  $Q_{s_j}$  out of  $V_{t_2}$ , when  $Q_{s_j}$  meets  $P_{t_2}$  and  $U(t_j)$  meets  $U(t_2)$ . Notice that these  $Q_{s_j}$  cannot meet  $V_{t_1}$  at parameters in  $U(t_1)$ . For if  $t_2$  is not  $u$ -compatible with  $t_1$  at some parameters in  $U(t_1)$ , then (by Lemma 5.5.1)  $Q_{s_j}$  cannot meet both  $P_{t_2}$  and  $P_{t_1}$ , while if it is  $u$ -compatible at some parameter in  $U(t_1)$ , then it has already been pushed out of  $V_{t_1}$ . And  $V_{t_1}$  cannot lie in any of the regions of parallelism for the pushouts from  $V_{t_2}$ , since the intersection circles of the  $Q_{s_j}$  with  $P_{t_2}$  are not longitudes in  $V_{t_2}$ .

After these pushouts are completed, if  $i = 1$  or  $i = 2$  and  $Q_{s_i}$  was  $V$ -cored, then  $V_{t_i}$  is concentric in either  $X_{s_i}$  or  $Y_{s_i}$  at all parameters in  $U_i$ .

We continue working up the increasing  $t_i$  in this way. At the end of this process,  $V_{t_i}$  is concentric in either  $X_{s_i}$  or  $Y_{s_i}$  for all  $i$  such that  $Q_{s_i}$  was  $V$ -cored, and at all parameters in  $U_i$ . For  $Q_{s_i}$  that were  $W$ -cored or bilongitudinal, the intersections  $Q_{s_i} \cap P_{t_i}$  have not been disturbed at parameters in  $U_i$ . We have not introduced any new intersections of  $Q_{s_i}$  with  $P_{t_j}$ , so we still have the property that at any parameter  $u$  in  $U_i \cap U(t_j)$ ,  $Q_{s_j}$  can meet  $P_{t_i}$  only if  $t_i$  and  $t_j$  were originally  $u$ -compatible.

*Step 2: Push the  $Q_{s_i}$  that meet  $P_{t_j}$  out of  $W_{t_j}$  for all the  $Q_{s_j}$  that are  $W$ -cored, at all parameters in  $U(t_j)$ .*

The entire process is repeated with  $W$ -cored levels, except that we start with  $t_m$  and proceed in order of decreasing  $t_i$ . Each  $W$ -cored  $Q_{s_i}$  is pushed out of  $W_{t_i}$ , and at the end of the process  $W_{t_i}$  is concentric in either  $X_{s_i}$  or  $Y_{s_i}$  at all parameters in  $U_i$ , whenever  $Q_{s_i}$  was  $W$ -cored. No intersection of a  $Q_{s_j}$  with a  $V$ -cored or bilongitudinal level  $P_{t_i}$  is changed at any parameter in  $U_i$ .

For the remaining steps, we fix a triangulation of  $S^d$  with mesh smaller than a Lebesgue number for  $\{U_i\}$ , which will ensure that  $B_\Delta$  is nonempty for every simplex  $\Delta$ . We will no longer proceed up or down all  $t_i$ -levels, working on the sets  $U_i$ , but instead will work inductively

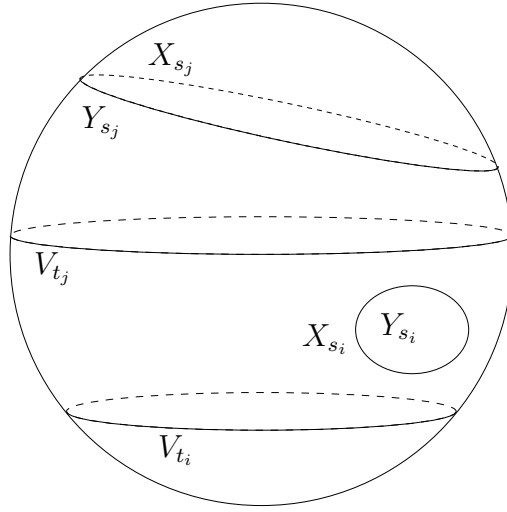

FIGURE 5.14. Hypothetical inconsistent nesting:  $V_{t_i} \subset X_{s_i}$  and  $V_{t_j} \subset Y_{s_j}$ .

up the skeleta of the triangulation. Recall that each  $B_\Delta$  is decomposed into blocks, according to the original intersections of the  $Q_{s_i}$  and  $P_{t_i}$  before steps 1 and 2 were performed.

*Step 3: Push the  $Q_{s_i}$  that were originally cored so that each one equals some level torus.*

We will proceed inductively up the skeleta of the triangulation, moving cored  $Q_{s_i}$  to level tori, without changing  $Q_{s_k} \cap P_{s_k}$  for the bi-longitudinal  $Q_{s_k}$ . We want to use the fact that  $V_{t_i}$  (or  $W_{t_i}$ ) is concentric with  $X_{s_i}$  or  $Y_{s_i}$  to push  $Q_{s_i}$  onto a level torus, but when moving multiple levels at a given parameter, there is a consistency condition needed. As shown in Figure 5.14, it might happen that  $V_{t_i}$  is concentric in  $X_{s_i}$  while  $V_{t_j}$  is concentric in  $Y_{s_j}$ . Then, we might not be able to push  $Q_{s_i}$  and  $Q_{s_j}$  onto level tori without disrupting other levels. The following lemma rules out this bad configuration.

LEMMA 5.12.3. *Suppose, after steps 1 and 2 have been completed, that  $u \in U_i \cap U(t_j)$ ,  $t_i < t_j$ , and that  $Q_{s_i}$  is  $V$ -cored.*

- (1) *The region between  $Q_{s_i}$  and  $Q_{s_j}$  does not contain a core circle of  $V_{t_i}$ .*
- (2) *Suppose that  $t_i$  and  $t_j$  are  $u$ -compatible, and  $V_{t_i}$  is concentric in  $Z_{s_i}$  where  $Z$  is  $X$  or  $Z$  is  $Y$ . Then  $V_{t_j}$  is concentric in  $Z_{s_j}$ .*
- (3) *If  $t_i$  and  $t_j$  are not  $u$ -compatible, then  $Q_{s_i}$  is parallel to  $P_{t_i}$  in  $R(t_i, t_j)$ .*

*The analogous statement holds when  $Q_{s_j}$  is  $W$ -cored and  $W_{t_j}$  is concentric in  $Z_{s_j}$ .*

PROOF. It suffices to consider the case when  $Q_{s_i}$  is  $V$ -cored. In the situation at the start of Step 1 above, when annuli in the  $Q_{s_k}$  were being pushed out of  $V_{t_i}$ , the intersection of  $Q_{s_i} \cup Q_{s_j}$  with  $V_{t_i}$  was a union  $F$  of incompressible nonlongitudinal annuli. Since  $Q_{s_i}$  met  $P_{t_i}$ ,  $F$  was nonempty. By Proposition 5.3.3, exactly one complementary region of  $F$  in  $V_{t_i}$  contained a core circle  $C$  of  $V_{t_i}$ . For at least one of  $s_i$  and  $s_j$ , say for  $s_k$ ,  $Q_{s_k}$  met this complementary region.

Since the annuli of  $F$  are nonlongitudinal, there is an embedded circle  $C'$  in  $Q_{s_k}$  that is homotopic in the core region to a proper multiple of  $C$ . If  $C$  were in the region  $R = f_u(R(s_i, s_j))$  between  $Q_{s_i}$  and  $Q_{s_j}$ , then the embedded circle  $C'$  in  $\partial R$  would be a proper multiple in  $\pi_1(R)$ , which is impossible since  $R$  is homeomorphic to  $S^1 \times S^1 \times I$ . This proves (1).

Assume that  $t_i$  and  $t_j$  are  $u$ -compatible and suppose that  $V_{t_i} \subset X_{s_i}$  and  $V_{t_j} \subset Y_{s_j}$ . Then  $C$  is contained in  $X_{s_i} \cap Y_{s_j}$ , forcing  $s_i > s_j$  and  $C$  in the region between  $Q_{s_i}$  and  $Q_{s_j}$ , contradicting (1). The case of  $V_{t_i} \subset Y_{s_i}$  and  $V_{t_j} \subset X_{s_j}$  is similar, so (2) holds.

For (3), if  $t_i$  and  $t_j$  are not  $u$ -compatible, then  $Q_{s_i}$  was initially disjoint from  $P_{t_j}$ , and hence is disjoint after steps 1 and 2. By Lemma 5.4.3(2),  $V_{t_i}$  is concentric in  $X_{s_i}$  or  $Y_{s_i}$  after steps 1 and 2, and part (3) follows.  $\square$

It will be convenient to extend our previous notation  $R(s, t)$  for the closure of the region between  $P_s$  and  $P_t$ , by putting  $R(0, t) = V_t$ ,  $R(t, 1) = W_t$ , and  $R(0, 1) = L$ .

We will now define target regions. The isotopies that we will use in the rest of our process will only change values within a single target region, ensuring that the necessary positioning of the  $Q_{s_i}$  is retained. Let  $\Delta$  be a simplex of the triangulation, and recall the decomposition of  $B_\Delta = \{b_1, \dots, b_m\}$  into maximal  $\Delta$ -compatible blocks  $C_1 = \{b_1, b_2, \dots, b_{\ell_1}\}$ ,  $C_2 = \{b_{\ell_1+1}, \dots, b_{\ell_2}\}$ ,  $\dots$ ,  $C_r = \{b_{\ell_{r-1}+1}, \dots, b_{\ell_r}\}$ . Define the *target region* of a block  $C_n$  to be the submanifold  $T_\Delta(C_n)$  of  $L$  defined as follows. Put  $\ell_0 = 0$ ,  $b_0 = 0$ , and  $b_{\ell_r+1} = 1$ .

- (1) If  $C_n$  is  $V$ -cored, then  $T_\Delta(C_n) = R(b_{\ell_{n-1}+1}, b_{\ell_n+1})$ .
- (2) If  $C_n$  is  $W$ -cored, then  $T_\Delta(C_n) = R(b_{\ell_{n-1}}, b_{\ell_n})$ .
- (3) If  $C_n$  is bilongitudinal, then  $T_\Delta(C_n) = R(b_{\ell_{n-1}}, b_{\ell_n+1})$ .

We remark that  $T_\Delta(C_n)$  is all of  $L$  when  $B_\Delta$  consists of a single bilongitudinal block, otherwise is of the form  $V_t$  when  $n = 1$  and  $C_1$  is  $W$ -cored or bilongitudinal and of the form  $W_t$  when  $n = r$  and  $C_n$  is  $V$ -cored or bilongitudinal, and in all other cases it is a region  $R(s, t)$  diffeomorphic to  $S^1 \times S^1 \times I$ .

As noted in the next lemma, the interior of the target region of a block contains the  $Q_{a_i}$  for the  $b_i$  in the block, at this point of our argument.

LEMMA 5.12.4. *Target regions satisfy the following.*

- (1) *If  $b_i \in C_n$  and  $u \in \Delta$ , then  $Q_{a_i}(u)$  is in the interior of  $T_\Delta(C_n)$ .*
- (2) *If  $\delta$  is a face of  $\Delta$ , and  $C'_1, \dots, C'_{r'}$  are the blocks of  $B_\delta$ , then for each  $i$ , there exists a  $j$  such that  $T_\delta(C'_i) \subseteq T_\Delta(C_j)$ .*

PROOF. Property (1) is a consequence of Proposition 5.12.2 and the fact that Steps 1 and 2 do not create new intersections of the  $Q_{s_i}(u)$  with the  $P_{t_j}$ . For part (2), the proof is direct from the definitions, dividing into various subcases.  $\square$

Target regions can overlap in the following ways: the target region for a  $V$ -cored block  $C_n$  will overlap the target region of a succeeding  $W$ -cored block  $C_{n+1}$ , and the target region of a bilongitudinal block will overlap the target region of a preceding  $V$ -cored block or of a succeeding  $W$ -cored block (note that by Lemma 5.11.1, successive blocks cannot both be bilongitudinal). The latter cause no difficulties, but the conjunctions of a  $V$ -cored block and a succeeding  $W$ -cored block will necessitate some care during the ensuing argument.

We can now begin the process that will complete Step 3. We will start at the parameters that are vertices of the triangulation and move the  $Q_{a_i}$  for each  $V$ -cored or  $W$ -cored block to be level, that is, so that each  $Q_{a_i}(u)$  equals some  $P_t$ . The isotopies will be fixed on each  $P_{b_i}$  for which  $Q_{a_i}$  is bilongitudinal, and these unchanged  $Q_{a_i} \cap P_{b_i}$  will be used to work with the bilongitudinal levels in a later step. For each cored block, the isotopy that levels the  $Q_{a_i}$  will move points only in the interior of the target region of the block. As we move to higher-dimensional simplices, the  $Q_{a_i}$  will already be level at parameters on the boundary, and the deformation will be fixed at those parameters. Each deformation for the parameters in a simplex  $\delta_0$  of dimension less than  $d$  must be extended to a deformation of  $f$ . The extension will change an  $f_u$  only when  $u$  is in the open star of  $\delta_0$ , by a deformation that performs some initial portion of the deformation of  $f_{u_0}$  at a parameter  $u_0$  of  $\delta_0$ —the parameter that is the  $\delta_0$ -coordinate of  $u$  when the simplex that contains it is written as a join  $\delta_0 * \delta_1$  (details will be given below). We will see that because the target regions can overlap, the deformation of an  $f_u$  might not preserve all target regions, but enough positioning of the image levels  $Q_{a_i}$  will be retained to continue the inductive process.

Fix a vertex  $\delta_0$  of the triangulation, and consider the first block  $C_1$  of  $B_{\delta_0}$ . If it is bilongitudinal, we do nothing. Suppose that it is

$V$ -cored. All of the  $Q_{a_1}, \dots, Q_{a_{\ell_1}}$  lie in the interior of the target region  $T_{\delta_0}(C_1)$ . Lemma 5.12.3(2) shows that for either  $Z = X$  or  $Z = Y$ ,  $V_{b_i}$  is concentric in  $Z_{a_i}$  for  $b_i \in C_1$ . We claim that there is an isotopy, supported on  $T_{\delta_0}(C_1)$ , that moves each  $Q_{a_i}$  to be level. If  $C_1$  is the only block, then  $T_{\delta_0}(C_1) = L$  and the isotopy exists by the definition of concentric. If there is a second block, then Lemma 5.12.3(3) shows that the  $Q_{a_i}$  for  $b_i \in C_1$  are parallel to  $P_{b_1}$  in  $T_{\delta_0}(C_1) = R(b_1, b_{\ell_1+1})$ , and again the isotopy exists. After performing the isotopy, we may assume that the  $Q_{a_i}(\delta_0)$  are level.

To extend this deformation of  $f_{\delta_0}$  to a deformation of the parameterized family  $f$ , we regard each simplex  $\Delta$  of the closed star of  $\delta_0$  in the triangulation as the join  $\delta_0 * \delta_1$ , where  $\delta_1$  is the face of  $\Delta$  spanned by the vertices of  $\Delta$  other than  $\delta_0$ . Each point of  $\Delta$  is uniquely of the form  $u = s\delta_0 + (1-s)u_1$  with  $u_1 \in \delta_1$ . Write the isotopy of  $f_{\delta_0}$  as  $j_t \circ f_{\delta_0}$ , with  $j_0$  the identity map of  $L$ . Then, at  $u$  the isotopy at time  $t$  is  $j_t \circ f_u$  for  $0 \leq t \leq s$  and  $j_s \circ f_u$  for  $s \leq t \leq 1$ . For any two simplices containing  $\delta_0$ , this deformation agrees on their intersection, so it defines a deformation of  $f$ .

The target region  $T_{\delta_0}(C_1)$  will overlap  $T_{\delta_0}(C_2)$  if  $C_2$  is bilongitudinal or  $W$ -cored. When  $C_2$  is bilongitudinal, this does not affect any of our necessary positioning. If it is  $W$ -cored, then  $Q_{a_i}$  with  $b_i \in C_2$  may be moved into  $T_{\delta_0}(C_1)$ . At  $\delta_0$ , such  $Q_{a_i}$  can end up somewhere between the now-level  $Q_{a_{\ell_1}}$  and  $P_{b_{\ell_2}}$ , and at other parameters in the star of  $\delta_0$  they will lie somewhere in  $R(b_1, b_{\ell_2})$ . This will require only a bit of attention in the later argument.

In case  $C_1$  was  $W$ -cored, we use Lemmas 5.12.3(2) and 5.11.5, producing a deformation of  $f_{\delta_0}$  supported on the interior of the solid torus  $T_{\Delta}(C_1) = V_{b_{\ell_1}}$ , which does not meet any other target region. This is extended to a deformation of  $f$  just as before.

We move on to consider  $C_2$  in analogous fashion, doing nothing if  $C_2$  is bilongitudinal, and moving the  $Q_{a_i}$  to be level at the parameter  $\delta_0$ . If  $C_1$  was  $V$ -cored and  $C_2$  is  $W$ -cored, then instead of the initial target region  $T_{\delta_0}(C_2)$  we must use the region between the now-level  $Q_{a_{\ell_1}}(u)$  and  $P_{b_{\ell_2}}$ , but otherwise the argument is the same. Proceed in the same way through the remaining blocks  $C_n$  of  $B_{\delta_0}$ , ending with all the cored  $Q_{a_i}(u_0)$  moved to be level. This process for  $u_0$  is repeated for each 0-simplex of the triangulation.

Now, consider a simplex  $\delta$  of positive dimension. Inductively, we may assume that at each  $u$  in  $\partial\delta$ , each cored  $Q_{a_i}$  has been moved to a level torus, and  $Q_{a_i} \cap Pb_i$  is unchanged for each bilongitudinal  $Q_{a_i}$ . Moreover, if  $a_i$  is contained in a cored block  $C_j$ , then  $Q_{a_i}$  lies in the

corresponding target region  $T_\delta(C_j)$ , or else lies in the union of the target regions for a  $V$ -cored block and a succeeding  $W$ -cored block.

We apply Lemma 5.11.5 to each cored block of  $B_\delta$ , sequentially up the cored blocks. We obtain a sequence of deformations of  $f$  on  $\delta$ , constant at parameters in  $\partial\delta$ . There is no interference between different blocks, except when a  $W$ -cored block  $C_{n+1}$  succeeds a  $V$ -cored block  $C_n$ . First, the  $Q_{a_i}$  for the  $V$ -cored block are moved to be level. Then, at each parameter in  $\delta$ , the  $Q_{a_i}(u)$  for the  $W$ -cored block lie between the now-level  $Q_{a_{\ell_n}}(u)$  and  $P_{b_{\ell_{n+1}}}$ . We regard the union of these regions over the parameters of  $\delta$  as a product  $\delta \times S^1 \times S^1 \times I$ , and apply Lemma 5.11.5. Thus the isotopy that levels the  $Q_{a_i}$  from the  $W$ -cored block need not move any of the  $Q_{a_i}$  from the  $V$ -cored block. In other cases, the successive isotopies take place in disjoint regions. To extend this to a deformation of  $f$ , we adapt the join method from above (of course when  $\delta$  is  $d$ -dimensional, no extension is necessary). Regard each simplex  $\Delta$  of the closed star of  $\delta$  in the triangulation as the join  $\delta * \delta_1$ , where  $\delta_1$  is the face of  $\Delta$  spanned by the vertices of  $\Delta$  not in  $\delta$ . Each point of  $\Delta$  is uniquely of the form  $u = su_0 + (1-s)u_1$  with  $u_0 \in \delta$  and  $u_1 \in \delta_1$ . Write the isotopy of  $f_{u_0}$  as  $j_t \circ f_{u_0}$ , with  $j_0$  the identity map of  $L$ . Then, at  $u$  the isotopy at time  $t$  is  $j_t \circ f_u$  for  $0 \leq t \leq s$  and  $j_s \circ f_u$  for  $s \leq t \leq 1$ . For any two simplices containing  $\delta$ , this deformation agrees on their intersection, so it defines a deformation of  $f$ .

At the completion of this process, each cored  $Q_{s_i}$  is level at all parameters in  $\Delta$ , whenever  $\Delta \subset U_i$ . The bilongitudinal  $Q_{s_i}$  may have been moved around some, but their intersections  $Q_{s_i} \cap P_{t_i}$  will not be altered at parameters for which  $t_i \in B_\Delta$  since these intersections will not lie in the interior of any target region for a cored level.

*Step 4: Push all cored  $Q_{s_i}$  to be vertical, that is, make each image of a fiber of  $P_{s_i}$  a fiber in  $L$ .*

Again we work our way up the simplices of the triangulation. Start at a 0-simplex  $\delta_0$ . Each cored  $Q_{a_i}(\delta_0)$  for  $b_i \in B_{\delta_0}$  is now level. By Lemma 5.11.2, the image fibers in  $Q_{a_i}(\delta_0)$  are isotopic in that level torus to fibers of  $L$ . Using Lemma 5.11.4, there is an isotopy of  $f_{\delta_0}$  that preserves the level tori and makes  $Q_{a_i}(\delta_0)$  vertical. This isotopy can be chosen to fix all points in other  $Q_{a_j}(\delta_0)$ , and is extended to a deformation of  $f$  by using the method of Step 3. We work our way up the skeleta; if  $\delta \subset U(b_i)$ , then for every  $u$  in  $\delta$ , each  $Q_{a_i}(u)$  is level torus, and at parameters  $u \in \partial\delta$ ,  $Q_{a_i}(u)$  is vertical. Using Lemma 5.11.4, we make the  $Q_{a_i}(u)$  vertical at all  $u \in \delta$ , and extend to a deformation of  $f$  as before. We repeat this for all levels of cored blocks.



*Step 5: Push all bilongitudinal  $Q_{s_i}$  to be vertical.*

Now, we examine the bilongitudinal levels. For a bilongitudinal level  $Q_{a_i}$  at a vertex  $\delta_0$ , Corollary 5.4.4 shows that the intersection circles are longitudes for  $X_{a_i}$  and  $Y_{a_i}$ . Lemma 5.11.1 then shows that the circles of  $Q_{a_i} \cap P_{b_j}$  are isotopic in  $Q_{a_i}$  and in  $P_{b_j}$  to fibers. First, use Lemma 4.8.1 to find an isotopy preserving levels, such that postcomposing  $f_{\delta_0}$  by the isotopy makes the intersection circles fibers of the  $P_{b_j}$ . Then, use Lemma 4.8.1 applied to  $f_{\delta_0}^{-1}$  to find an isotopy preserving levels of the domain, such that precomposing  $f_{\delta_0}$  by the isotopy makes the intersection circles the images of fibers of  $P_{s_i}$ . After this process has been completed for the bilongitudinal  $Q_{a_i}$ , the inverse image (in their union  $\cup Q_{a_i}$ ) of each region  $R(b_j, b_{j+1})$  with  $b_j$  or  $b_{j+1}$  in a bilongitudinal block is a collection of fibered annuli which map into  $R(b_j, b_{j+1})$  by embeddings that are fiber-preserving on their boundaries. We use Lemma 4.8.2 to find an isotopy that makes the  $Q_{a_i}$  vertical. Again, we extend to a deformation of  $f$  and work our way up the skeleta, to assume that  $Q_{s_i}(u)$  is vertical whenever  $u \in \Delta$  and  $\Delta \subset U_i$ .

*Step 6: Make  $f$  fiber-preserving on the complementary  $S^1 \times S^1 \times I$  or solid tori of the  $P_{s_i}$ -levels*

We work our way up the skeleta one last time, using Lemma 5.11.3 to make  $f$  fiber-preserving on the complementary  $S^1 \times S^1 \times I$  or solid tori of the  $P_{a_i}$ .

There is an annoying technical problem that arises in this step. At each parameter, the deformations that make  $f_u$  fiber-preserving on the  $S^1 \times S^1 \times I$  are fixed on the boundaries of these submanifolds, but the extended diffeomorphisms may have to move points on the other side of the frontier. Thus, a region where  $f_u$  was already fiber-preserving may be changed to make  $f_u$  no longer fiber-preserving there. One fix for this is as follows. We can arrange that the final  $f$  has all  $f_u$  fiber-preserving except on small product neighborhoods of a finite set of levels at each parameter. Then by removing a neighborhood of the singular circles and their images, we can regard  $f$  as a parameterized family of diffeomorphisms of  $S^1 \times S^1 \times I$  that is fiber-preserving on a neighborhood of the boundary at each parameter. Then we apply the following version of Theorem 3.9.1:

**THEOREM 5.12.5.** *Suppose that  $\Sigma$  is a Seifert-fibered 3-manifold with boundary and  $g: \Sigma \times W \rightarrow \Sigma$  is a parameterized family of diffeomorphisms, with  $W$  compact, such that each  $g_u$  is fiber-preserving on a neighborhood of  $\partial\Sigma$ . Then there is a deformation of  $g$ , relative to  $U \times W$  for some open neighborhood  $U$  of  $\partial\Sigma$  in  $\Sigma$ , to a family of fiber-preserving diffeomorphisms.*

To prove this, we know from Theorem 3.9.1 that there is some deformation from  $g$  to a family  $h$  of fiber-preserving diffeomorphisms. Since the inclusion  $\text{diff}_f(\partial\Sigma) \rightarrow \text{diff}(\partial\Sigma)$  is a homotopy equivalence, the restriction of this deformation to  $\partial\Sigma$  can be assumed to be fiber-preserving at all times. Choosing a collar  $\partial\Sigma \times I$  in which each  $\Sigma \times \{t\}$  is a union of fibers, we may use uniqueness of collars to change the deformation to be fiber-preserving on the collar. Now, by performing less and less of the deformation as one moves toward  $\partial\Sigma$ , obtain a new deformation from  $g$  to a fiber-preserving family  $h'$  such that  $h' = h$  outside  $\partial\Sigma \times I$ , but  $h = g$  on  $\partial\Sigma \times [0, 1/2]$ .  $\square$

### 5.13. Parameters in $D^d$

Regard  $D^d$  as the unit ball in  $d$ -dimensional Euclidean space, with boundary the unit sphere  $S^{d-1}$ . As mentioned in Section 5.2, to prove that  $\text{diff}_f(L) \rightarrow \text{diff}(L)$  is a homotopy equivalence, we actually need to work with a family of diffeomorphisms  $f$  of  $L$  parameterized by  $D^d$ ,  $d \geq 1$ , for which  $f(u)$  is fiber-preserving whenever  $u$  lies in the boundary  $S^{d-1}$ . We must deform  $f$  so that each  $f(u)$  is fiber-preserving, by a deformation that keeps  $f(u)$  fiber-preserving at all times when  $u \in S^{d-1}$ .

We now present a trick that allows us to gain good control of what happens on  $S^{d-1}$ . The Hopf fibering we are using on  $L$  can be described as a Seifert fibering of  $L$  over the round 2-sphere  $S$ , in such a way that each isometry of  $L$  projects to an isometry of  $S$ . For the cases when  $q = 1$ , the round sphere is the actual quotient orbifold, and when  $1 < q$ , the quotient orbifold has two cone points but the only induced isometries are rotations fixing those cone points. (Section 4.4 above details this description for the manifolds considered in Chapter 4, full details of all cases are in [46].) By conjugating  $\pi_1(L)$  in  $\text{SO}(4)$ , we may assume that the singular fibers, when  $q > 1$ , are the inverse images of the poles. We choose our sweepout so that the level tori are the inverse images of latitude circles. Denote by  $p_t$  the latitude circle that is the image of the level torus  $P_t$ .

There is an isotopy  $J_t$  with  $J_0$  the identity map of  $L$  and each  $J_t$  fiber-preserving, so that the images of the level tori  $P_s$  under  $J_1$  project to circles in the 2-sphere as indicated in Figure 5.15. Denote the image of  $J_1(P_s)$  in  $S$  by  $q_s$ . Their key property is that when moved by any orthogonal rotation of  $S$ , each  $p_t$  meets the image of some  $q_s$  transversely in two or four points.

Using Theorem 5.2.1, we may assume that  $f_u$  is actually an isometry of  $L$  for each  $u \in S^{d-1}$ . Denote the isometry that  $f_u$  induces on  $S$  by

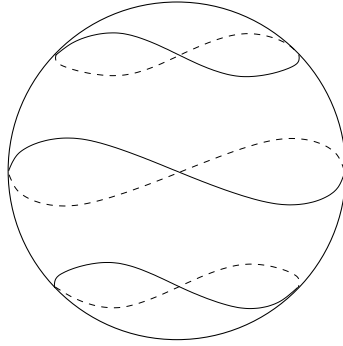
FIGURE 5.15. Projections of the  $J_1(P_t)$  into the 2-sphere.

$\overline{f_u}$ . Now, deform the entire family  $f$  by precomposing each  $f_u$  with  $J_t$ . At points in  $S^{d-1}$ , each  $f_u \circ J_t$  is fiber-preserving, so this is an allowable deformation of  $f$ . At the end of the deformation, for each  $u \in S^{d-1}$ ,  $f_u \circ J_1(P_s)$  is a fibered torus  $Q_s$  that projects to  $\overline{f_u}(q_s)$ . Since  $\overline{f_u}$  is an isometry of  $S$ , it follows that for any latitude circle  $p_t$ , some  $\overline{f_u}(q_s)$  meets  $p_t$  transversely, in either two or four points. So  $P_t$  and this  $Q_s$  meet transversely in either two or four circles which are fibers of  $L$ . In particular, they are in very good position. We call such a pair  $P_t$  and  $Q_s$  at  $u$  an *instant pair*.

Cover  $S^{d-1}$  by finitely many open sets  $Z'_i$  such that for each  $i$ , there is an  $(x_i, y_i)$  such that  $Q_{x_i}$  and  $P_{y_i}$  are an instant pair at every point of  $\overline{Z'_i}$ . We may assume that there are open sets  $Z_i$  in  $D^d$  such that  $\overline{Z_i} \cap S^{d-1} = \overline{Z'_i}$  and  $Q_{x_i}$  and  $P_{y_i}$  meet in very good position at each point of  $\overline{Z_i}$ . For any sufficiently small deformation of  $f$ ,  $Q_{x_i}$  and  $P_{y_i}$  will still meet in very good position at all points of  $\overline{Z_i}$ . Let  $V$  be a neighborhood of  $S^{d-1}$  in  $D^d$  such that  $\overline{V}$  is contained in the union of the  $Z_i$ .

Now, we apply to  $D^d$  the entire process used for the case when the parameters lie in  $S^d$ , using appropriate fiber-preserving deformations at parameters in  $S^{d-1}$ . Here are the steps:

- (1) By Theorem 5.8.2, there are arbitrarily small deformations of  $f$  that put it in general position with respect to the sweep-out. Select the deformation sufficiently small so that the  $Q_{x_i}$  and  $P_{y_i}$  still meet in very good position at every point of  $\overline{Z_i}$ . Within  $V$ , we taper the deformation off to the identity, so that no change has taken place at parameters in  $S^{d-1}$ . At every parameter, either there is already a pair in very good position, or  $f_u$  satisfies the conditions (GP1), (GP2), and (GP3) of a general position family.

- (2) Theorem 5.9.1 guarantees that at each of the parameters in  $D^d - V$ , there is a pair  $Q_s$  and  $P_t$  meeting in good position.
- (3) Applying Theorem 5.10.1 to  $D^d$ , with  $S^{d-1}$  in the role of  $W_0$ , we find a deformation of  $f$ , fixed on  $S^{d-1}$ , and a covering  $U_i$  of  $D^d$  and associated values  $s_i$  so that for every  $u \in U_i$ ,  $Q_{s_i}$  and  $P_{t_i}$  meet in very good position, and  $Q_{s_i}$  has no discal intersection with any  $P_{t_j}$ .
- (4) In the pushout step of the proof of Theorem 5.12.1, we may assume that all the  $U_i$  that meet  $S^{d-1}$  are the open sets  $Z_i$ . At parameters  $u$  in  $S^{d-1}$ , the annuli to be pushed out of each  $V_{t_i}$  will be vertical annuli. The pushouts may be performed using fiber-preserving isotopies at these parameters, because the necessary deformations can be taken as lifts of deformations of circles in the quotient sphere  $S$ , the lifting being possible by Theorem 3.6.10.
- (5) After the triangulation of  $D^d$  is chosen, the deformation that move the  $Q_{s_i}$  onto level tori can be performed using fiber-preserving isotopies at parameters in  $S^{d-1}$ , again because the necessary deformations cover deformations of circles in the quotient surface  $S$ . No further deformation will be needed on simplices in  $S^{d-1}$ , since the  $f_u$  are already fiber-preserving there.

This completes the discussion of the case of parameters in  $D^d$ , and the proof of the Smale Conjecture for lens spaces.

## Bibliography

- [1] C. Aneziris, A. P. Balachandran, M. Bourdeau, S. Jo, R. D. Sorkin, and T. R. Ramadas. Aspects of spin and statistics in generally covariant theories. *Internat. J. Modern Phys. A*, 4(20):5459–5510, 1989.
- [2] Kouhei Asano. Homeomorphisms of prism manifolds. *Yokohama Math. J.*, 26, no. 1:19–25, 1978.
- [3] Augustin Banyaga. *The structure of classical diffeomorphism groups, Mathematics and its Applications, 400*. Kluwer Academic Publishers Group, Dordrecht, 1997.
- [4] C. Bessaga and Aleksander Pelczynski. *Selected topics in infinite-dimensional topology, Monografie Matematyczne, Tom 58. [Mathematical Monographs, Vol. 58]*. PWN—Polish Scientific Publishers, Warsaw, 1975.
- [5] Michel Boileau and Jean-Pierre Otal. Scindements de Heegaard et groupe des homeotopies des petites varietes de Seifert. *Invent. Math.*, 106, no. 1:85–107, 1991.
- [6] Francis Bonahon. Difféotopies des espaces lenticulaires. *Topology*, 22, no. 3:305–314, 1983.
- [7] Glen E. Bredon and John W. Wood. Non-orientable surfaces in orientable 3-manifolds. *Invent. Math.*, 7:83–110, 1969.
- [8] J. W. Bruce. On transversality. *Proc. Edinburgh Math. Soc. (2)*, 29, no. 1:115–123, 1986.
- [9] A. J. Casson and C. McA.Gordon. Reducing Heegaard splittings. *Topology Appl.*, 27, no. 3:275–283, 1987.
- [10] Jean Cerf. Topologie de certains espaces de plongements. *Bull. Soc. Math. France*, 89:227–380, 1961.
- [11] Jean Cerf. *Sur les difféomorphismes de la sphère de dimension trois ( $\Gamma_4 = 0$ )*, *Lecture Notes in Mathematics, No. 53*. Springer-Verlag, Berlin-New York, 1968.
- [12] L. S. Charlap and A. T. Vasquez. Compact flat riemannian manifolds. III. The group of affinities. *Amer. J. Math.*, 95:471–494, 1973.
- [13] R. P. Filipkiewicz. Isomorphisms between diffeomorphism groups. *Ergodic Theory Dynamical Systems 2*, no. 2:159–171, 1982.
- [14] J. Friedman and R. Sorkin. Spin 1/2 from gravity. *Phys. Rev. Lett.*, 44:1100–1103, 1980.
- [15] David Gabai. The Smale Conjecture for hyperbolic 3-manifolds:  $\text{Isom}(M^3) \simeq \text{Diff}(M^3)$ . *J. Differential Geom.*, 58, no. 1:113–149, 2001.
- [16] Christopher G. Gibson, Klaus Wirthmüller, Andrew A. du Plessis, and Eduard J. N. Looijenga. *Topological stability of smooth mappings*. Lecture Notes in Mathematics, Vol. 552. Springer-Verlag, Berlin, 1976.

- [17] Domenico Giulini. On the configuration space topology in general relativity. *Helv. Phys. Acta*, 68, no. 1:86–111, 1995.
- [18] Domenico Giulini and Jorma Louko. No-boundary  $\theta$  sectors in spatially flat quantum cosmology. *Phys. Rev. D (3)*, 46, no. 10:4355–4364, 1992.
- [19] Andre Gramain. Le type d’homotopie du groupe des difféomorphismes d’une surface compacte. *Ann. Sci. École Norm. Sup. (4)*, 6:53–66, 1973.
- [20] Richard S. Hamilton. The inverse function theorem of Nash and Moser. *Bull. Amer. Math. Soc. (N.S.)*, 7, no. 1:65–222, 1982.
- [21] W. Hantsche and W. Wendt. Drei dimensionali Euklidische Raumformen. *Math. Ann.*, 110:593–611, 1934.
- [22] Allen E. Hatcher. Homeomorphisms of sufficiently large  $\mathbb{P}^2$ -irreducible 3-manifolds. *Topology*, 15, no. 4:343–347, 1976.
- [23] Allen E. Hatcher. On the diffeomorphism group of  $S^1 \times S^2$ . *Proc. Amer. Math. Soc.*, 83, no. 2:427–430, 1981.
- [24] Allen E. Hatcher. A proof of the Smale conjecture,  $\text{Diff}(S^3) \simeq \text{O}(4)$ . *Ann. of Math. (2)*, 117, no. 3:553–607, 1983.
- [25] Allen E. Hatcher. On the diffeomorphism group of  $S^1 \times S^2$ . revised version posted at <http://www.math.cornell.edu/~hatcher/>, 2007.
- [26] John Hempel. *3-Manifolds*. Ann. of Math. Studies, No. 86. Princeton University Press, Princeton, N. J, 1976.
- [27] David W. Henderson. Corrections and extensions of two papers about infinite-dimensional manifolds. *General Topology and Appl.*, 1:321–327, 1971.
- [28] David W. Henderson and R. Schori. Topological classification of infinite dimensional manifolds by homotopy type. *Bull. Amer. Math. Soc.*, 76:121–124, 1970.
- [29] Harrie Hendriks. La stratification naturelle de l’espace des fonctions différentiables réelles n’est pas la bonne. *C. R. Acad. Sci. Paris Ser. A-B*, 274:A618–A620, 1972.
- [30] C. J. Isham. Topological  $\theta$ -sectors in canonically quantized gravity. *Phys. Lett. B*, 106, no. 3:188–192, 1981.
- [31] N. V. Ivanov. Groups of diffeomorphisms of Waldhausen manifolds, Studies in topology, II. *Zap. Nau?n. Sem. Leningrad. Otdel. Mat. Inst. Steklov. (LOMI)*, 66:172–176, 209, 1976.
- [32] N. V. Ivanov. Corrections: “Homotopies of automorphism spaces of some three-dimensional manifolds”. *Dokl. Akad. Nauk SSSR*, 249, no. 6:1288, 1979.
- [33] N. V. Ivanov. Diffeomorphism groups of Waldhausen manifolds. *J. Soviet Math.*, 12:115–118, 1979.
- [34] N. V. Ivanov. Homotopies of automorphism spaces of some three-dimensional manifolds. *Dokl. Akad. Nauk SSSR*, 244, no. 2:274–277, 1979.
- [35] N. V. Ivanov. Homotopy of spaces of diffeomorphisms of some three-dimensional manifolds. *Zap. Nauchn. Sem. Leningrad. Otdel. Mat. Inst. Steklov. (LOMI)*, 122:72–103, 164–165, 1982.
- [36] N. V. Ivanov. Homotopy of spaces of diffeomorphisms of some three-dimensional manifolds. *J. Soviet Math.*, 26:1646–1664, 1984.
- [37] William Jaco. *Lectures on three-manifold topology CBMS Regional Conference Series in Mathematics, 43*. American Mathematical Society, Providence, R.I., 1980.

- [38] William Jaco and Peter B. Shalen. Seifert fibered spaces in 3-manifolds. *Mem. Amer. Math. Soc.*, 21, no. 220:viii+192 pp., 1979.
- [39] H. Karcher. Riemannian center of mass and mollifier smoothing. *Comm. Pure Appl. Math.*, 30(5):509–541, 1977.
- [40] Tsuyoshi Kobayashi and Osamu Saeki. The Rubinstein-Scharlemann graphic of a 3-manifold as the discriminant set of a stable map. *Pacific J. Math.*, 195, no. 1:101–156, 2000.
- [41] Andreas Kriegl and Peter W. Michor. *The convenient setting of global analysis*. Mathematical Surveys and Monographs, 53. American Mathematical Society, Providence, RI, 1997.
- [42] Francois Laudenbach. Topologie de la dimension trois: homotopie et isotopie. *Astérisque, Société Mathématique de France, Paris*, No. 12:i+152 pp, 1974.
- [43] John L. Friedman and Donald M. Witt. Homotopy is not isotopy for homeomorphisms of 3-manifolds. *Topology*, 25, no. 1:35–44, 1986.
- [44] A. Lundell and S. Weingram. *The Topology of CW Complexes*. Van Nostrand Reinhold, Princeton, New Jersey, 1969.
- [45] John N. Mather. Stability of  $C^\infty$  mappings. iii. Finitely determined mapgerms. *Inst. Hautes Etudes Sci. Publ. Math.*, No. 35:279–308, 1968.
- [46] Darryl McCullough. Isometries of elliptic 3-manifolds. *J. London Math. Soc. (2)*, 65, no. 1:167–182, 2002.
- [47] Darryl McCullough and Teruhiko Soma. The Smale conjecture for Seifert fibered spaces with hyperbolic base orbifold. arXiv:1005.5061, 2010.
- [48] W. Neumann and F. Raymond. Automorphisms of Seifert manifolds. preprint, 1979.
- [49] Peter Orlik. *Seifert Manifolds*. Lecture Notes in Mathematics, Vol. 291. Springer-Verlag, Berlin-New York, 1972.
- [50] E. Vogt P. Orlik and H. Zieschang. Zur Topologie gefaserner dreidimensionaler Mannigfaltigkeiten. *Topology*, 6:49–64, 1967.
- [51] Richard S. Palais. Local triviality of the restriction map for embeddings. *Comment. Math. Helv.*, 34:305–312, 1960.
- [52] Richard S. Palais. Homotopy theory of infinite dimensional manifolds. *Topology*, 5:1–16, 1966.
- [53] Chan-Young Park. Homotopy groups of automorphism groups of some Seifert fiber spaces. dissertation at the University of Michigan, 1989.
- [54] Chan-Young Park. On the weak automorphism group of a principal bundle, product case. *Kyungpook Math. J.*, 31, no. 1:25–34, 1991.
- [55] Jon T. Pitts and J. H. Rubinstein. Applications of minimax to minimal surfaces and the topology of 3-manifolds. *Miniconference on geometry and partial differential equations, Canberra*, 2:137–170, 1987.
- [56] J. H. Rubinstein. On 3-manifolds that have finite fundamental group and contain Klein bottles. *Trans. Amer. Math. Soc.*, 251:129–137, 1979.
- [57] J. H. Rubinstein and J. S. Birman. One-sided Heegaard splittings and homeotopy groups of some 3-manifolds. *Proc. London Math. Soc. (3)*, 49, no. 3:517–536, 1984.
- [58] J. H. Rubinstein and Martin Scharlemann. Comparing Heegaard splittings of non-Haken 3-manifolds. *Topology*, 35, no. 4:1005–1026, 1996.
- [59] Makoto Sakuma. The geometries of spherical Montesinos links. *Kobe J. Math.*, 7, no. 2:167–190, 1990.

- [60] Peter Scott. The geometries of 3-manifolds. *Bull. London Math. Soc.*, 15, no. 5:401–487, 1983.
- [61] R. T. Seeley. Extension of  $C^\infty$  functions defined in a half space. *Proc. Amer. Math. Soc.*, 15:625–626, 1964.
- [62] H. Seifert. Topologie Dreidimensionaler Gefasertes Raume. *Acta Math.*, 60, no. 1:147–238, 1933.
- [63] Francis Sergeraert. Un théorème de fonctions implicites sur certains espaces de Fréchet et quelques applications. *Ann. Sci. École Norm. Sup. (4)*, 5:599–660, 1972.
- [64] Stephen Smale. Diffeomorphisms of the 2-sphere. *Proc. Amer. Math. Soc.*, 10:621–626, 1959.
- [65] Rafael D. Sorkin. Classical topology and quantum phases: quantum geons. *Geometrical and algebraic aspects of nonlinear field theory*, North-Holland Delta Ser., North-Holland, Amsterdam:201–218, 1989.
- [66] Floris Takens. Characterization of a differentiable structure by its group of diffeomorphisms. *Bol. Soc. Brasil. Mat.*, 10, no. 1:17–25, 1979.
- [67] Jean-Claude Tougeron. Une généralisation du théorème des fonctions implicites. *C. R. Acad. Sci. Paris Ser. A-B*, 262:A487–A489, 1966.
- [68] Jean-Claude Tougeron. Idéaux de fonctions différentiables. i. *Ann. Inst. Fourier (Grenoble)*, 18, fasc. 1:177–240, 1968.
- [69] Friedhelm Waldhausen. Eine Klasse von 3-dimensionalen Mannigfaltigkeiten. i, ii. *Invent. Math.*, 3 ibid. 4:308–333; 87–117, 1967.
- [70] Friedhelm Waldhausen. Gruppen mit Zentrum und 3-dimensionale Mannigfaltigkeiten. *Topology*, 6:505–517, 1967.
- [71] Friedhelm Waldhausen. On irreducible 3-manifolds which are sufficiently large. *Ann. of Math. (2)*, 87:56–88, 1968.
- [72] C. T. C. Wall. Finite determinacy of smooth map-germs. *Bull. London Math. Soc.*, 13, no. 6:481–539, 1981.
- [73] Donald M. Witt. Symmetry groups of state vectors in canonical quantum gravity. *J. Math. Phys.*, 27, no. 2:573–592, 1986.
- [74] Joseph A. Wolf. *Spaces of constant curvature, Third edition*. Publish or Perish, Inc, Boston, Mass., 1974.



## Index

Mathematical symbols appear separately at the beginning of the index, and are repeated in their lexicographical position later. Page numbers given in **boldface** indicate the location of the main definition of the item, and those in *italics* indicate statements of results.

|  |                     |   |              |
|--|---------------------|---|--------------|
| $\mathcal{A}$ -equivalent .....                                  | <b>124</b>          | $\text{Emb}(V, M \text{ rel } S)$ .....       | <b>21</b>    |
| $\mathcal{A}(W, TE)$ .....                                       | <b>17</b>           | $\text{Emb}^K(V, M \text{ rel } S)$ .....     | <b>22</b>    |
| $\mathcal{A}^L(W, TE)$ .....                                     | <b>22</b>           | $\text{Emb}_v(W, E)$ .....                    | <b>15</b>    |
| $\text{cdim}(f)$ .....   | <b>126</b>          | $\text{Emb}(\mathcal{W}, \mathcal{O})$ .....  | <b>34</b>    |
| $C^\infty(M, N)$ .....   | <b>9</b>            | $\text{Exp}_a$ .....                          | <b>16</b>    |
| $C_H^\infty(\mathcal{O})$ .....                                  | <b>33</b>           | $\text{Exp}_v$ .....                          | <b>16</b>    |
| $(C^\infty)_H^A(\tilde{\mathcal{O}})$ .....                      | <b>36</b>           | $\bar{g}$ .....                               | <b>30</b>    |
| $C_m$ .....  | <b>2</b>            | $\Gamma$ (graph in flattened surface) . . . . | <b>78</b>    |
| $\partial_h E, \partial_v E$ .....                               | <b>14</b>           | $H_x(E)$ .....                                | <b>15</b>    |
| $\partial_h W, \partial_v W$ .....                               | <b>15, 40</b>       | $I$ .....                                     | <b>9</b>     |
| $\partial_h \Sigma, \partial_v \Sigma$ .....                     | <b>40</b>           | $\mathcal{I}(M)$ .....                        | <b>2</b>     |
| $\text{diff}(M)$ .....   | <b>9</b>            | $\Im(z_0 + z_1 j)$ .....                      | <b>64</b>    |
| $\text{Diff}_f(E)$ .....   | <b>14</b>           | $\text{emb}(M)$ .....                         | <b>9</b>     |
| $\text{Diff}_f(\Sigma)$ .....                                    | <b>40</b>           | $\text{Img}(V, M)$ .....                      | <b>26</b>    |
| $\text{Diff}_H^A(\tilde{\mathcal{O}})$ .....                     | <b>36</b>           | $\text{Isom}_+(S^3/G)$ .....                  | <b>64</b>    |
| $\text{Diff}^L(M \text{ rel } X)$ .....                          | <b>21</b>           | $\text{isom}(M)$ .....                        | <b>2</b>     |
| $\text{Diff}^{M-X}(M)$ .....                                     | <b>21</b>           | $I_{120}^*$ .....                             | <b>2</b>     |
| $\text{Diff}(M \text{ rel } X)$ .....                            | <b>13, 21</b>       | $J$ (subgroup of $S^3$ ) .....                | <b>64</b>    |
| $\text{Diff}(M, V)$ .....  | <b>26</b>           | $j^k f$ .....                                 | <b>124</b>   |
| $\text{Diff}_v(E)$ .....   | <b>14</b>           | $K_0$ .....                                   | <b>59</b>    |
| $\text{Dih}(S^1 \times S^1)$ .....                               | <b>2</b>            | $L(m, q)$ .....                               | <b>2, 95</b> |
| $D_{4m}^*$ .....   | <b>2, 5, 60, 64</b> | $M(m, n)$ .....                               | <b>59</b>    |
| $\text{Emb}_f(W, E)$ .....                                       | <b>15</b>           | $\text{Norm}(G)$ .....                        | <b>65</b>    |
| $\text{Emb}_H(\tilde{\mathcal{W}}, \tilde{\mathcal{O}})$ .....   | <b>34</b>           | $O(2)$ .....                                  | <b>1, 64</b> |
| $\text{Emb}_H^A(\tilde{\mathcal{W}}, \tilde{\mathcal{O}})$ ..... | <b>36</b>           | $O(2)^*$ .....                                | <b>1, 67</b> |
| $\text{Emb}(V, M)$ .....   | <b>14</b>           | $O_{48}^*$ .....                              | <b>2</b>     |
| $\text{Emb}^K(V, M)$ .....                                       | <b>21</b>           | $O(2)^* \tilde{\times} O(2)^*$ .....          | <b>2, 69</b> |
|  |                     | $P$ (I-bundle) .....                          | <b>59</b>    |
|  |                     | $P$ (quaternions) .....                       | <b>64</b>    |
|  |                     | $\pi_1(M(m, n))$ .....                        | <b>60</b>    |
|  |                     | $P_t$ .....                                   | <b>108</b>   |
|  |                     | $Q_s$ .....                                   | <b>108</b>   |
|  |                     | $R$ .....                                     | <b>59</b>    |
|  |                     | $R(s, t)$ .....                               | <b>105</b>   |
|  |                     | $rD^2$ .....                                  | <b>103</b>   |
|  |                     | $\Re(z_0 + z_1 j)$ .....                      | <b>64</b>    |

- $\mathcal{R}$ -equivalent ..... 124
- $S^1 \widetilde{\times} S^1$  ..... 2
- $S^1 \widetilde{\times} S^3$  ..... 2
- $sA, sB, sX, sY$  ..... 110
- TExp ..... 12
- $T_{24}^*$  ..... 2
- $\widetilde{\times}$  ..... 2
- $T_u$  ..... 62, 63, 77
- $V_t, W_t$  ..... 105
- $\mathcal{V}(W, TE)$  ..... 17
- $\mathcal{V}^L(W, TE)$  ..... 22
- $V_x(E)$  ..... 15
- $\omega_v, \omega_h$  ..... 15
- $\mathcal{X}_H(\widetilde{W}, T\widetilde{\mathcal{O}})$  ..... 34
- $\xi_k$  ..... 64
- $\mathcal{X}(V, TM), \mathcal{X}^L(V, TM)$  ..... 12
- $\mathcal{Y}(M, TM)$  ..... 9
- $\mathcal{Y}(V, TM), \mathcal{Y}^L(V, TM)$  ..... 11
- $Z$  ..... 11
- $Z$ -compatible ..... 153
  
- adjacent regions in graphic ..... 110
- $\mathcal{A}$ -equivalent ..... 124
- aligned
  - exponential ..... 16
  - equivariance ..... 42
  - vector field ..... 16
- Anderson-Kadec Theorem ..... 5
- $\mathcal{A}(W, TE)$  ..... 17
- $\mathcal{A}^L(W, TE)$  ..... 22
  
- base Klein bottle ..... 61, 70
- basic isotopy ..... 144
- biessential ..... 96, 102
  - after basic isotopy ..... 97, 144, 146
- bigon move ..... 139
- bilongitudinal
  - levels ..... 152
- birth-death point ..... 108
- Bonahon
  - method for  $\pi_0(\text{Diff}(L))$  ..... 97
- border label control ..... 119, 131–132
  - and labels in graphic ..... 119
- boundary
  - horizontal ..... 14
  - vertical ..... 14
- Bruce ..... 96, 124
  - weak general position theorem ..... 120
  - for parameterized family ..... 120
  
- $\text{cdim}(f)$  ..... 126
- center
  - critical point type ..... 108
- center of mass ..... 46
- Cerf. .... vii, 4, 19
- $C^\infty(M, N)$  ..... 9
- $C_H^\infty(\mathcal{O})$  ..... 33
- $(C^\infty)_H^A(\widetilde{\mathcal{O}})$  ..... 36
- $C_m$  ..... 2
- codimension
  - and singularity type ..... 125
  - of real-valued function ..... 125–127
- compatible
  - $Z$ -compatible parameters ..... 153
- concentric solid torus ..... 103
- core circles
  - does not create ..... 135
- core region ..... 99
- cored ..... 152
- corners ..... 10, 14
- critical point
  - birth-death type ..... 108
  - center type ..... 108
  - saddle type ..... 108
  - stable ..... 108
- crossover point ..... 136
  
- deformation
  - of parameterized family ..... 57
- $\partial_h E, \partial_v E$  ..... 14
- $\partial_h W, \partial_v W$  ..... 15, 40
- $\partial_h \Sigma, \partial_v \Sigma$  ..... 40
- diagonal subgroup ..... 2, 60, 66
- Diagram ..... 111
- $\text{diff}(M)$  ..... 9
- diffeomorphism
  - fiber-preserving ..... 14
  - orbifold ..... 33
  - vertical ..... 14
- $\text{Diff}_f(E)$  ..... 14
- $\text{Diff}_f(\Sigma)$  ..... 40
- $\text{Diff}_H^A(\widetilde{\mathcal{O}})$  ..... 36
- $\text{Diff}^L(M \text{ rel } X)$  ..... 21
- $\text{Diff}(M)$ 
  - CW-complex ..... 10
  - Fréchet structure ..... 13
  - homeomorphism type ..... 5–6
  - isomorphism type ..... 6

- Lie structure.....12–13
- local convexity ..... 13
- nonelliptic 3-manifolds ..... 6–7
- $\text{Diff}^{M-X}(M)$ ..... **21**
- $\text{Diff}(M \text{ rel } X)$ ..... **13, 21**
- $\text{Diff}(M, V)$ ..... **26**
- $\text{Diff}_v(E)$ ..... **14**
- $\text{Dih}(S^1 \times S^1)$ ..... **2**
- discal ..... 96, **102**
- $D_{4m}^*$ ..... **2, 5, 60, 64**
- elliptic ..... **1**
- embedding
  - fiber-preserving ..... **15**
  - orbifold ..... **34**
  - vertical ..... **15**
- $\text{Emb}_f(W, E)$ ..... **15**
- $\text{Emb}_H(\widetilde{\mathcal{W}}, \widetilde{\mathcal{O}})$ ..... **34**
- $\text{Emb}_H^A(\widetilde{\mathcal{W}}, \widetilde{\mathcal{O}})$ ..... **36**
- $\text{Emb}(V, M)$ 
  - Fréchet structure..... 14
- $\text{Emb}(V, M)$ ..... **14**
- $\text{Emb}^K(V, M)$ ..... **21**
- $\text{Emb}(V, M \text{ rel } S)$ ..... **21**
- $\text{Emb}^K(V, M \text{ rel } S)$ ..... **22**
- $\text{Emb}_v(W, E)$ ..... **15**
- $\text{Emb}(\mathcal{W}, \mathcal{O})$ ..... **34**
- equivalence
  - of germs of smooth maps..... 124
- equivariant ..... **33, 34**
- Riemannian metric ..... 34
- smooth function ..... 34
- vector field..... **34**
- examples
  - local triviality and Lie groups . . 22
  - meridional annuli in a solid torus
    - 100
    - graphic with no unlabeled region
      - 113–116
    - flattened torus with two meridian
      - disks..... 140
    - flattened torus in  $L(2, 1)$  with two
      - meridian disks ..... 141
    - nested ball regions ..... 147
    - level tori out of order ..... 151
    - hypothetical inconsistent nesting
      - 156
  - $\text{Exp}_a$ ..... **16**
  - exponential
    - vertical ..... **16**
  - Exponentiation Lemma ..... 25
    - for fiber-preserving maps 29, 32, 44
  - $\text{Exp}_v$ ..... **16**
  - Extension Lemma..... 24
    - for fiber-preserving maps ..... 28
    - equivariant ..... 37, 39
    - for fiber-preserving maps ..... 43
    - for singular fiberings ..... 43, 44
    - Seeley ..... 12, 13, 14, 25, 30, 38
  - fiber-preserving
    - diffeomorphism ..... **14**
    - embedding ..... **15**
  - fibered submanifold ..... **15**
  - figures
    - $T$  a neighborhood of  $T \cap S$  ..... 29
    - canonical straightening ..... 47
    - flattened surfaces, local picture . 78
    - flattened saddle tangency..... 79
    - flattened surface near original
      - intersection arc..... 79
    - removal of a bigon by isotopy... 82
    - an exceptional  $K \cap K_0$  for  $M(1, 1)$ 
      - 83
    - meridional annuli in a solid torus
      - 100
    - Heegaard torus with bad
      - meridional annuli ..... 102
    - complicated configuration of
      - intersecting levels ..... 106
    - the Diagram ..... 111
    - graphic with no unlabeled region
      - 114
    - sweepout with no unlabeled region
      - 116
    - ascending and descending arcs in a
      - graphic ..... 134
    - up and down edges..... 137
    - tunnel arc and tunnel move . . 138
    - flattened torus with two meridian
      - disks..... 140
    - nested ball regions ..... 147
    - out of order level tori ..... 151
    - inconsistent nesting ..... 156
    - projection of a perturbed level 162
  - finite multiplicity ..... 76
  - finite multiplicity type..... 62

- finite singularity type . . . . . 123–125  
 finitely determined . . . . . **124**  
 flattened surface . . . . . **78**  
 flattening . . . . . 62, 135  
   isotopy . . . . . **81**  
 Fréchet space . . . . . **5**  
  
 $\bar{g}$  . . . . . **30**  
 Gabai . . . . . 7  
 $\Gamma$  (graph in flattened surface) . . . . **78**  
 general position . . . . . 96  
   of parameterized family . . . . . 119  
   with respect to sweepout . . . . . **119**  
 Generalized Smale Conjecture . . . . v  
 generic position . . . . . 62, **77**, 84, 86  
 Geometrization Conjecture . . . . . 1, 7  
 germs of smooth maps  
   types of equivalence . . . . . 124  
 good position . . . . . 96, **102**, 142  
 (GP1), (GP2), (GP3) . **119**, 132, 135,  
   163  
 graph . . . . . **119**  
 graphic . . . . . 96  
   Rubinstein-Scharlemann . . . . . **110**  
  
 Hantsche-Wendt manifold . . . . . 53  
 Hatcher . v, vi, 4, 6, 7, 21, 55, 63, 87,  
   97, 142, 145, 152  
 Hattori . . . . . 1  
 Heegaard torus . . . . . **101**, 149  
 Hendriks . . . . . 128  
 homeomorphism type of  $\text{Diff}(M)$  . 6  
 Hopf fibering  
   of  $M(m, n)$  . . . . . 61, **67**  
   of  $S^3$  . . . . . 61  
   of lens space . . . . . 98  
 horizontal  
   boundary . . . . . **14**  
   lift . . . . . **15**  
   path . . . . . **15**  
   subspace of  $T_x E$  . . . . . **15**  
   tangent vector . . . . . **15**  
 $H_x(E)$  . . . . . **15**  
  
 $I$  . . . . . **9**  
 $\mathcal{I}(M)$  . . . . . **2**  
 $\mathfrak{S}(z_0 + z_1 j)$  . . . . . **64**  
 image labels . . . . . **143**  
 emb( $M$ ) . . . . . **9**  
  
 $\text{Img}(V, M)$  . . . . . **26**  
 instant pair . . . . . **163**  
 intersection  
   biessential . . . . . 96  
   discal . . . . . 96  
 $\text{Isom}_+(S^3/G)$  . . . . . **64**  
 isometries  
   calculation of  $\text{isom}(\pi_1(M(m, n)))$  .  
     65–66  
 isometry groups  
   calculation . . . . . 65–66  
 $\text{isom}(M)$  . . . . . **2**  
 isotopy  
   basic . . . . . **144**  
 Isotopy Extension Theorem . . . . . 19  
 isotopy lifting . . . . . 31  
 $I_{120}^*$  . . . . . **2**  
 Ivanov . . . . . v, 4, 6, 21, 55, 63, 142  
  
 $J$  (subgroup of  $S^3$ ) . . . . . **64**  
 jets . . . . . 124  
 $j^k f$  . . . . . **124**  
  
 $K_0$  . . . . . 59  
 (K1), (K2), (K3) . . . . . **112**  
 Karcher . . . . . 46  
  
 $L(m, q)$  . . . . . **2**, 95  
 labels  
   and border label control in  
     graphics . . . . . 119  
   image . . . . . **143**  
   key properties . . . . . 110  
   of regions . . . . . 109  
 Laudenbach . . . . . 6  
 lens spaces . . . . . 40  
 level  
   of sweepout . . . . . **105**  
 levels . . . . . **77**, 95, 143  
 lift  
   horizontal . . . . . **15**  
 lifting isotopies to bundles . . . . . 31  
 local cross-section . . . . . **22**  
 Logarithm Lemma . . . . . 23, 57  
   equivariant . . . . . 37, 39, 42  
   for fiber-preserving maps . . . . . 28, 43  
   for singular fiberings . . . . . 43, 44  
 longitude  
   in level . . . . . **77**

- in solid torus.....**99**
- longitudinal
  - annulus.....**99**
  - fibering of  $K_0$ ..... 4, 53, 59, 61
- lower-case convention..... 9
- $M(m, n)$  .....**59**
  - is lens space when  $m = 1$ ..... 60
- manifold with corners.....**10**
- Mather ..... 124, 125
- meridian .....**77**
  - of solid torus.....**99**
- meridian disk .....**99**
- meridional
  - annulus.....**100**
  - figure ..... 100
  - fibering of  $K_0$ ..... 4, 53, 59, 61, 77
- Morse general position .....**108**
- Morse type .....**108**
- neighborhood of a submanifold ... **21**
- Neumann..... 20
- normalizer..... 65
- Norm( $G$ ).....**65**
- $O(2)$ ..... **1**, 64
- $O(2)^*$  ..... **1**, 67
- orbifold ..... **33**
  - diffeomorphism ..... **33**
  - homeomorphism ..... **33**
- $O_{48}^*$  ..... **2**
- $O(2)^* \times \tilde{O}(2)^*$ ..... **2**, 69
- $P$  (I-bundle) ..... **59**
- $P$  (quaternions)..... **64**
- Palais ..... vi, vii, 10
- Palais method..... 23–26
  - Exponentiation Lemma..... 25
  - Extension Lemma..... 24
  - Logarithm Lemma ..... 23
- Palais-Cerf Restriction Theorem . 20, 90
- Parameterized Extension Principle 57
- Parameterized Isotopy Lifting
  - Theorem..... 19, 31
- Park ..... 20
- path
  - horizontal.....**15**
- Perelman ..... 1, 7–8
- $\pi_1(K_0)$ 
  - standard presentation ..... 59
- $\pi_1(M(m, n))$  ..... 60
- pinched regular neighborhood ... **136**
- precompressing disk.....**109**
- precompression ..... **109**
- prism manifold ..... 60
- product near  $\partial_h E$  ..... **15**
- product near the boundary ... **10**, 40
- Projection Theorem
  - bundles ..... 31
  - Palais-Cerf..... 19
  - singular fiberings 43, 55, 74, 75, 86, 92
- projection-restriction square ..... 20
  - fiber-preserving ..... 33
  - singular fiberings ..... 45
- $P_t$  ..... **108**
- pure imaginary quaternions..... 64
- $Q_s$ .....**108**
- quaternionic manifold ..... 60
- quaternions ..... 1, 64–65
- $R$ ..... **59**
- $R(s, t)$  ..... **105**
- Raymond..... 20
- $rD^2$  ..... **103**
- $\Re(z_0 + z_1 j)$  ..... **64**
- region
  - target ..... **157**
- regions
  - of graph ..... **109**
- $\mathcal{R}$ -equivalent..... **124**
- Restriction Theorem..... 20
  - fiber-preserving ..... 20
  - orbifolds ..... 39, 51, 73
- Palais-Cerf
  - relative version ..... 26, 33, 93
  - relative fiber-preserving..... 32, 33
  - singular fiberings 45, 51, 54, 75, 93
  - to boundary of orbifold ..... 50
  - to point ..... 51, 91
- Riemannian metric
  - complete..... **10**
  - equivariant ..... 40
  - product near the boundary..... **10**
- (RS1), (RS2), (RS3) .. **110**, 112, 134, 141
- Rubinstein-Scharlemann

- graphic ..... 96, **110**
- method ..... 95, 108–113
- $S^1 \widetilde{\times} S^1$  ..... **2**
- $S^1 \widetilde{\times} S^3$  ..... **2**
- $sA, sB, sX, sY$  ..... **110**
- saddle
  - critical point type ..... **108**
- Sard's Theorem ..... 131, 143
- Scharlemann ..... vi, 97
- Seeley
  - Extension Lemma ..... 12
- Seifert-fibered 3-manifold ..... 20
- semialgebraic sets ..... 124–125
- Sergeraert ..... 96, 125
  - Stratification Theorem ..... 127
- $\sigma$ -level ..... **108**
- singular fiberings ..... 20, **39**
  - and Seifert fiberings ..... 40
  - very good ..... **45**
- singular point
  - of  $S \cap T$  ..... **76**
- singularity
  - finite type ..... 123–125
- singularity type
  - and finite codimension ..... 125
- Smale ..... 3
- Smale Conjecture ..... v, 1, 3
  - current status ..... vi
  - for incompressible Klein bottle
    - case ..... 4, 75
    - for lens spaces ..... 5
    - in physics ..... 6
    - $\pi_0$ -part ..... 4
  - small-letter convention ..... 9
  - space of fibered structures ..... **45**
  - space of images of a submanifold . 14, **26**
  - space of Seifert fiberings ... v, 20, **52**
    - contractibility ..... 53
  - space of singular fiberings ..... **45**
    - Fréchet structure ..... 45
- special
  - Klein bottle ..... 61, **68**
  - suborbifold of  $\mathcal{O}$  ..... **68**
  - torus ..... **68**
- spine ..... **105**
- square
  - projection-restriction ..... 20
  - fiber-preserving ..... 33
  - singular fiberings ..... 45
- stable
  - critical point ..... **108**
  - tangency ..... **108**
- straightening fibers ..... 46–49
- stratification ..... **125**
  - of space of real-valued functions  
127–131
- strongly irreducible
  - Heegaard splitting ..... **109**
  - sweepout ..... **109**
- submanifold
  - fibered ..... **15**
  - meeting collar in I-fibers ..... **11**
  - vertical ..... **15**
- suborbifold ..... **34**
  - of the boundary ..... 49
- subspace
  - horizontal ..... **15**
  - vertical ..... **15**
- sweepout ..... 95, **105**
- table
  - isom( $M(m, n)$ ) calculations ..... 66
  - isometry groups ..... 2
  - quotient orbifolds ..... 67
  - Smale Conjecture status ..... vi
- tame exponential ..... **12**, 13, 17
- target region ..... **157**
- Tarski-Seidenberg Theorem . 124, 129
- $\tau$ -level ..... **108**
- TExp ..... **12**
- Thom transversality ..... 120
- $T_{24}^*$  ..... **2**
- $\times$  ..... **2**
- $T_u$  ..... 62, 63, **77**
- tunnel move ..... **138**
- $V$ -cored ..... **152**
- vector field
  - aligned ..... **16**
- vertical
  - boundary ..... **14**
  - diffeomorphism ..... **14**
  - embedding ..... **15**
  - exponential ..... **16**
  - submanifold ..... **15**
  - suborbifold ..... **40**

|  |                          |
|--|--------------------------|
| subspace of $T_x E$ .....                                      | <b>15</b>                |
| tangent vector .....   | <b>15</b>                |
| very good  |                          |
| position .....   | 96, <b>102</b> , 142–148 |
| singular fibering .....  | <b>45</b>                |
| $V_t, W_t$ .....   | <b>105</b>               |
| $\mathcal{V}(W, TE)$ .....                                     | <b>17</b>                |
| $\mathcal{V}^L(W, TE)$ .....                                   | <b>22</b>                |
| $V_x(E)$ .....   | <b>15</b>                |
| Waldhausen .....   | 53, 93                   |
| Waldhausen's Theorem .....                                     | 7                        |
| $W$ -cored .....   | <b>152</b>               |
| weak transversality .....                                      | 120–123                  |
| $\omega_v, \omega_h$ .....                                     | <b>15</b>                |
| $\mathcal{X}_H(\widetilde{W}, T\widetilde{\mathcal{O}})$ ..... | <b>34</b>                |
| $\xi_k$ .....  | <b>64</b>                |
| $\mathcal{X}(V, TM), \mathcal{X}^L(V, TM)$ .....               | <b>12</b>                |
| $\mathcal{Y}(M, TM)$ .....                                     | <b>9</b>                 |
| Yagasaki .....   | 12                       |
| $\mathcal{Y}(V, TM), \mathcal{Y}^L(V, TM)$ .....               | <b>11</b>                |
| $Z$ .....  | <b>11</b>                |
| $Z$ -compatible .....  | <b>153</b>               |